



**BRIGHTTEK**  
**BRIGHTTEK (EUROPE) LIMITED**

*Brighten up The World With LED!*



ISO/TS 16949:2009



BS EN ISO 14001:2004



QC 080000 IECQ HSPM

## PRODUCT DATASHEET



- ▶ PLCC2 SMD
- ▶ 4014 0.65t
- ▶ Warm White 3000K

NOW64S02



Release Date: 01 February 2023 Version: A1.0



### 4014 EMC Series

**RoHS**  
Compliant



#### FEATURES:

- **Package:** Top View PLCC2 White Package
- **Forward Current:** 60mA
- **Forward Voltage (typ.):** 2.8V
- **Luminous Flux (typ.):** 30lm@60mA
- **Colour:** Warm White
- **Colour Temperature (CCT):** 3000K
- **Viewing angle:** 120°
- **Materials:**
  - Die: InGaN
  - Resin: Silicon (Yellow Diffused)
  - Package: PLCC
- **Operating Temperature:** -40~+85°C
- **Storage Temperature:** -40~+85°C
- **Electrostatics Discharge:** 1000V
- **Grouping parameters:**
  - Forward Voltage
  - Luminous Flux
  - CIE Chromaticity
- **Soldering methods:** Reflow Soldering
- **MSL Level:** MSL3 according to J-STD020
- **Packing:** 12mm tape with max.4000/reel, ø178mm (7")

#### APPLICATIONS:

- General Lighting
- Portable Lighting
- Commercial Lighting
- Indoor Lighting
- Backlight for LCD

## CHARACTERISTICS:

### Absolute Maximum Characteristics (Ta=25°C)

Parameter	Symbol	Ratings	Unit
DC Forward Current	I <sub>F</sub>	90	mA
Pulse Forward Current (Duty 1/10, width≤100μS)	I <sub>PF</sub>	120	mA
Power Dissipation	P <sub>D</sub>	270	mW
Reverse Voltage	V <sub>R</sub>	5	V
Reverse Current @10V	I <sub>R</sub>	10	μA
Junction Temperature	T <sub>j</sub>	105	°C
Electrostatic Discharge	ESD	1000	V
Thermal Resistance (Junction to Solder Point)	R <sub>THJS</sub>	16	°C/W
Operating Temperature	T <sub>OPR</sub>	-40~+85	°C
Storage Temperature	T <sub>STG</sub>	-40~+85	°C
Soldering Temperature	T <sub>SOL</sub>	245 for 10S	°C
Colour Rendering Index	CRI	80	---

### Electrical & Optical Characteristics (Ta=25°C, RH=60%)

Parameter	Symbol	Values			Unit	Test Condition
		Min.	Typ.	Max.		
Forward Voltage	V <sub>F</sub>	2.6	2.8	3.0	V	I <sub>F</sub> =60mA
Luminous Flux	Φ <sub>v</sub>	28	30	34	lm	I <sub>F</sub> =60mA
Chromaticity Coordinates	X	---	0.4342	---	---	I <sub>F</sub> =60mA
	Y	---	0.4028	---		
Colour Temperature	CCT	---	3000	---	K	I <sub>F</sub> =60mA
Viewing Angle	2θ <sub>1/2</sub>	---	120	---	deg	I <sub>F</sub> =60mA

1. Luminous flux (Φ<sub>v</sub>) ±10%, Forward Voltage (V<sub>F</sub>) ±0.1V, CRI ±2

## OUTLINE DIMENSION:

Package Dimension:

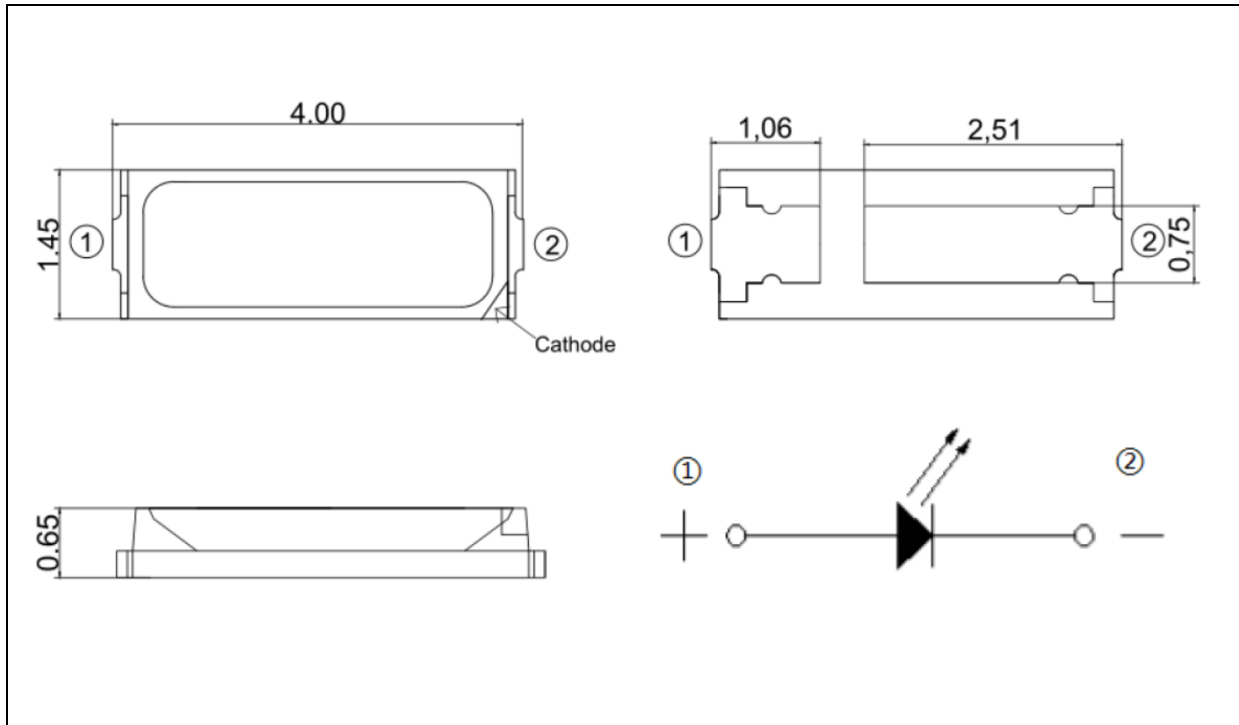

1. All dimensions are in millimetre (mm).
2. Tolerance  $\pm 0.2$ mm, unless otherwise noted.

Recommended Soldering Pad Dimension:

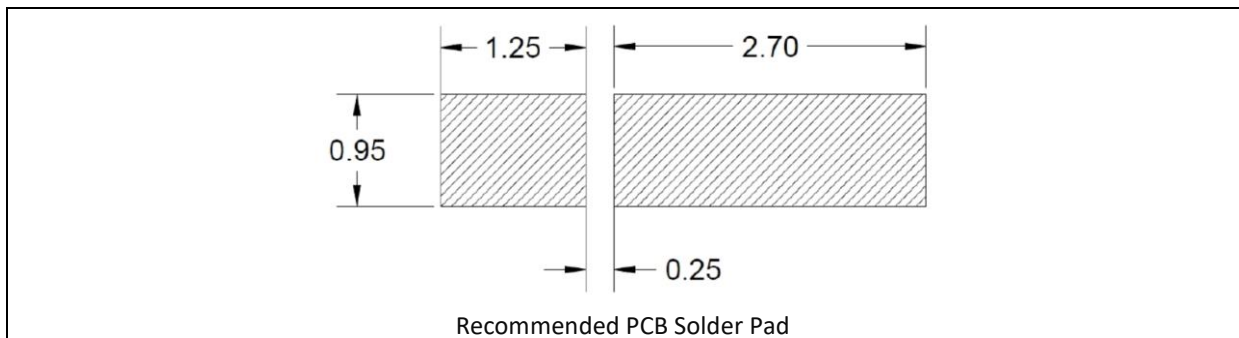

1. Dimensions are in millimetre (mm).
2. Tolerance  $\pm 0.1$ mm with angle tolerance  $\pm 0.5^\circ$ .

**BINNING GROUPS:**



---

 Forward Voltage Classifications ( $I_F = 60\text{mA}$ ):

Code	Min.	Max.	Unit
Z1	2.6	2.7	V
A1	2.7	2.8	
B1	2.8	2.9	
C1	2.9	3.0	

 Luminous Flux Classifications ( $I_F = 60\text{mA}$ ):

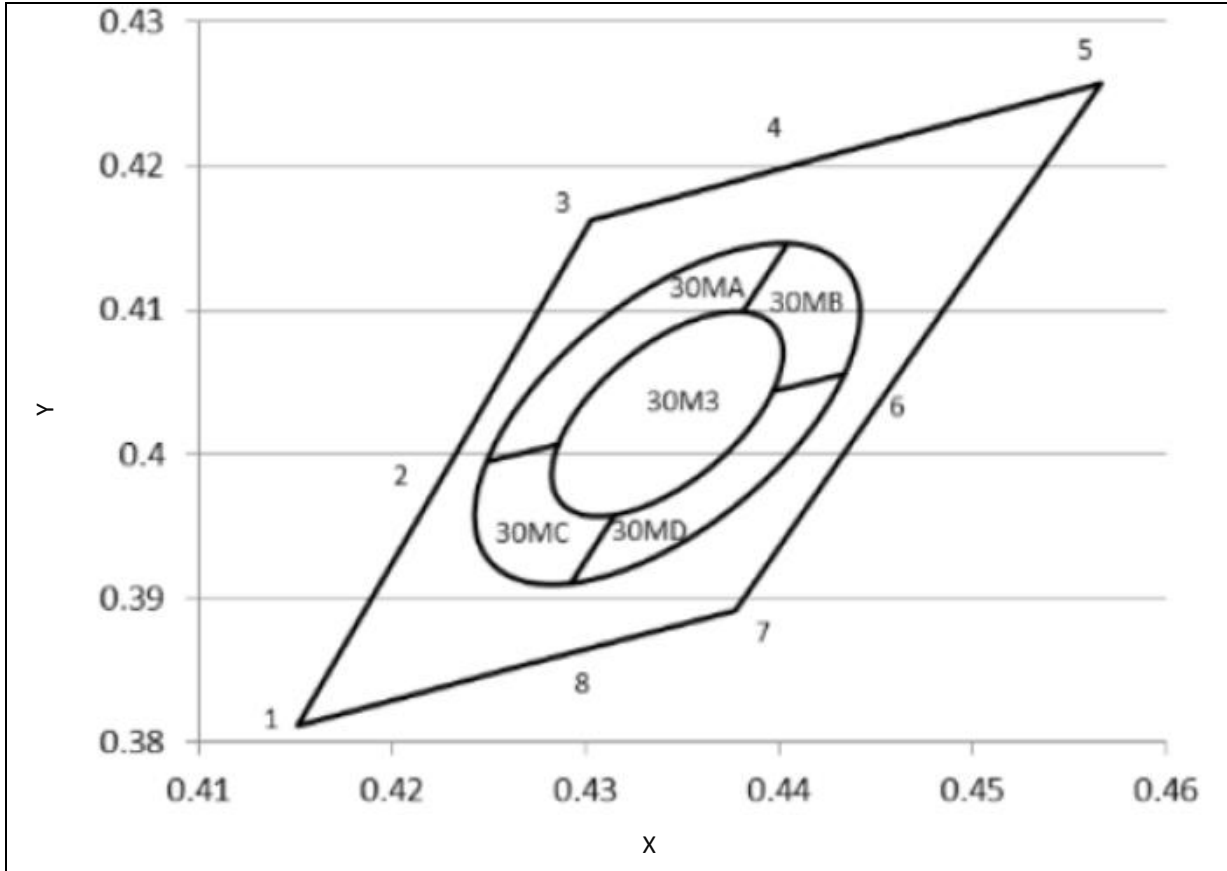
Code	Min.	Max.	Unit
D7	28	30	lm
D8	30	32	
D9	32	34	

**CIE CHROMATICITY DIAGRAM:**

**Chromaticity Coordinates Classifications ( $I_F = 60\text{mA}$ ):**

Code	Centre		Radius		Angle
	X	Y	a	b	$\Phi$
30M5	0.4342	0.4028	0.002780	0.001360	53.13

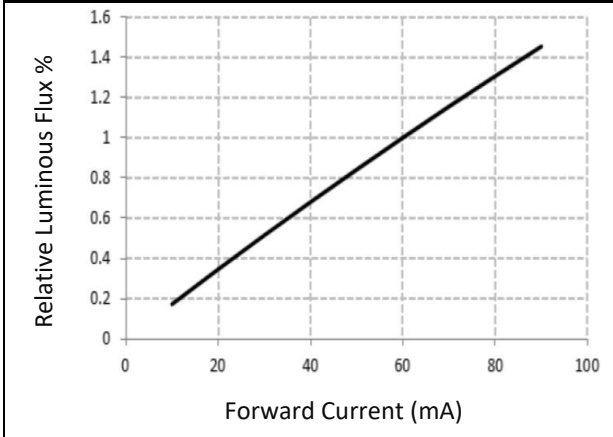
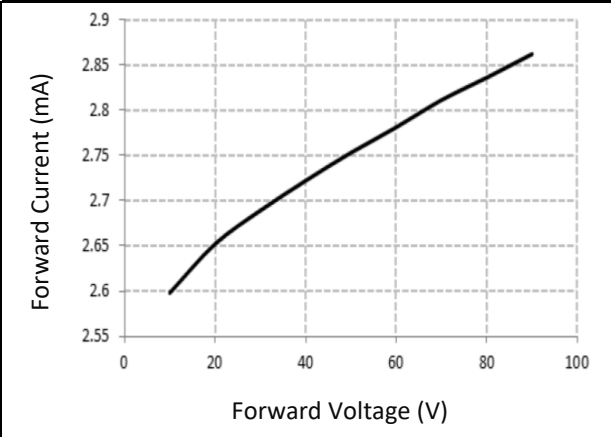
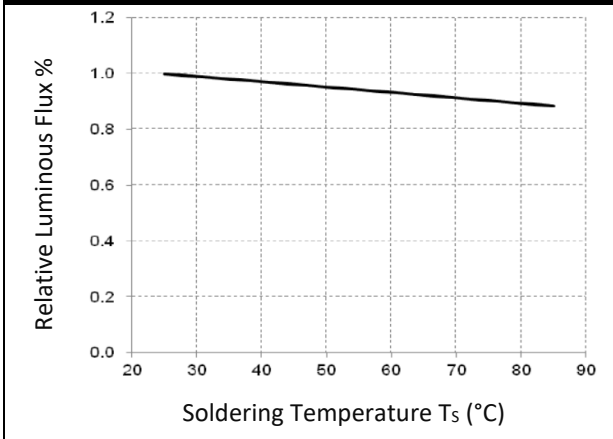
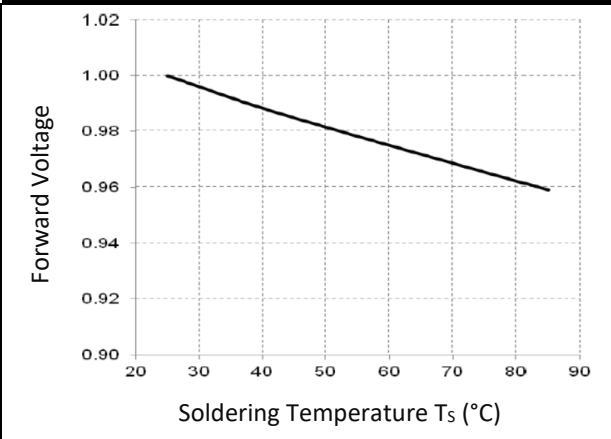
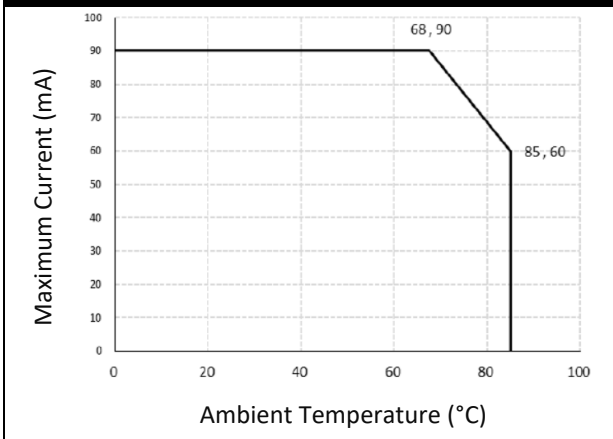
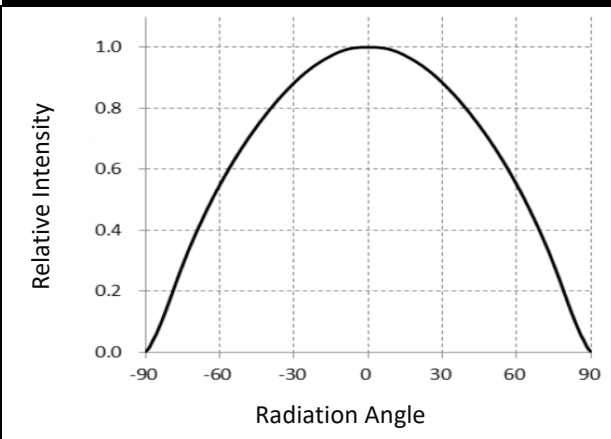
	1		3		5		7	
	X	Y	X	Y	X	Y	X	Y
3000K	0.4151	0.3812	0.4303	0.4163	0.4566	0.4258	0.4377	0.3891

**ELECTRO-OPTICAL CHARACTERISTICS:**
**Relative Luminous Flux v.s. Forward Current**

**Forward Current v.s. Forward Voltage**

**Relative Luminous Flux v.s. Soldering Temp.**

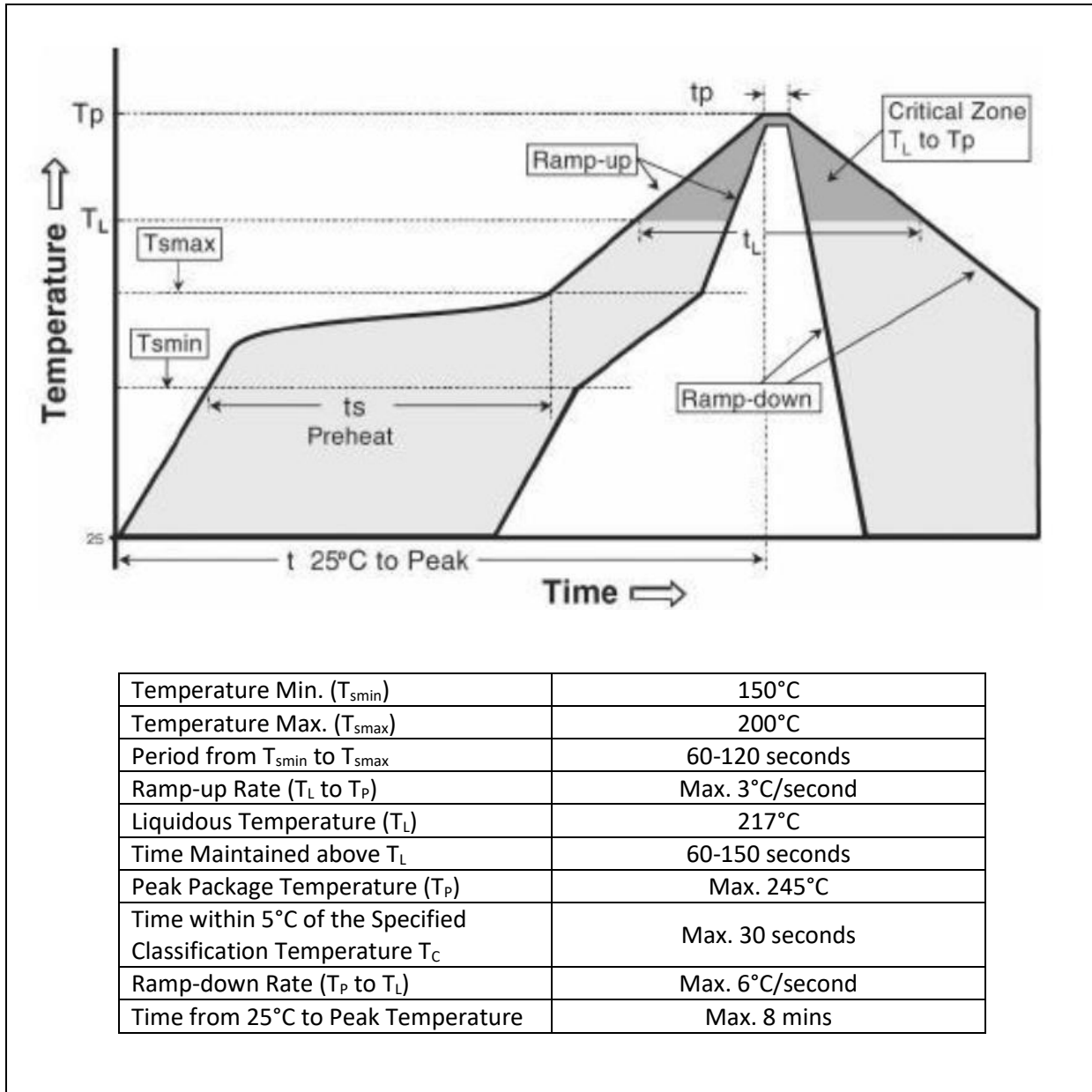
**Forward Voltage v.s. Soldering Temp.**

**Forward Current Derating Curve**

**Directive Radiation**

## RECOMMENDED SOLDERING PROFILE:

Reflow Lead-free Solder:



Note:

1. Maximum reflow soldering: 2 times.
2. Before, during, and after soldering, should not apply stress on the components and PCB board.
3. Recommended soldering temperature: 230°C. The maximum soldering temperature should be limited to 245°C for max. 10seconds.

## PACKING SPECIFICATION:

Reel Dimension:

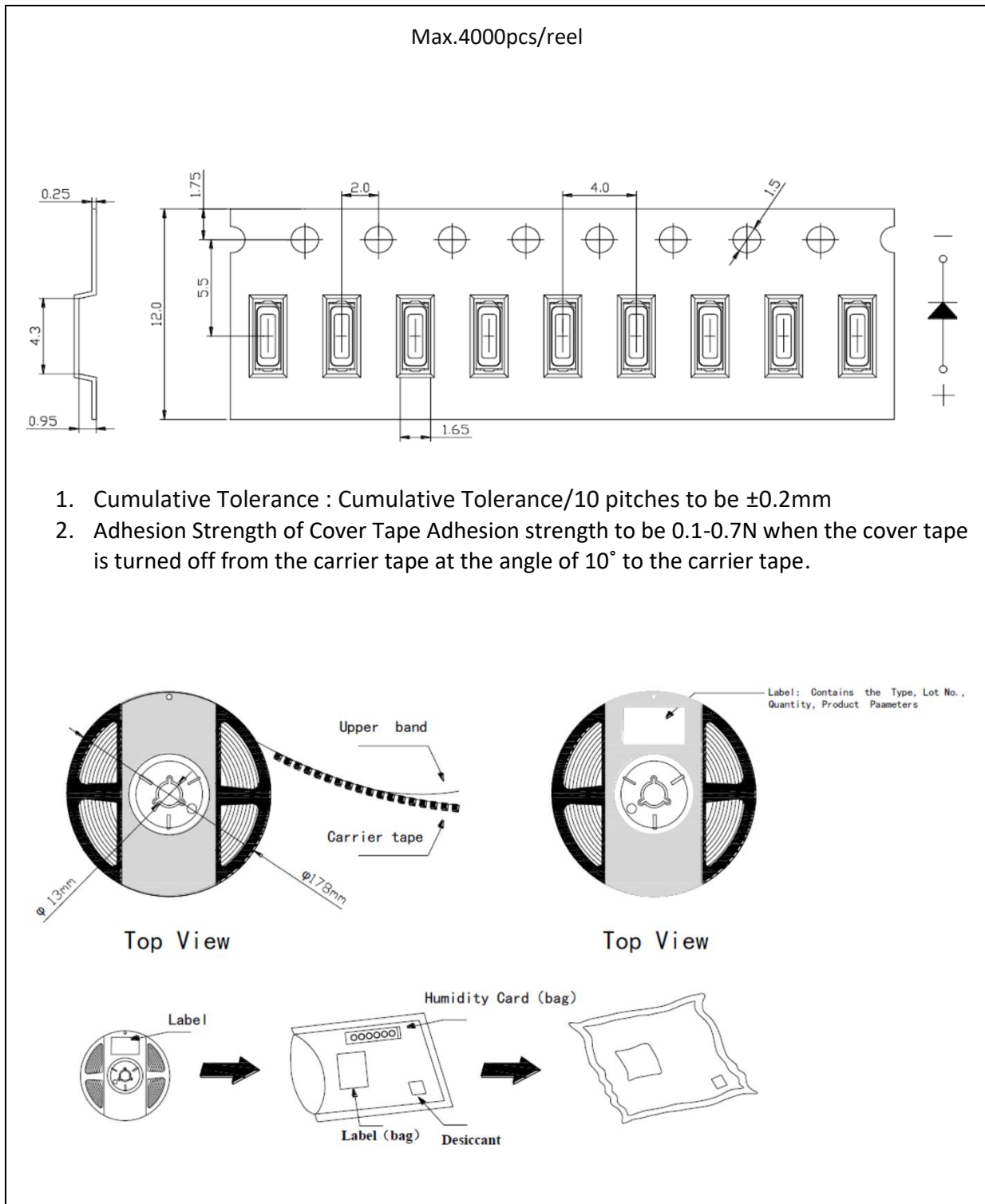



## PRECAUTIONS OF USE:

---

### Storage:

It is recommended to store the products in the following conditions:

- Humidity: 60% R.H. Max.
- Temperature: 5°C~30°C (41°F ~86°F).

Shelf life in sealed bag: 12 months at 5°C~30°C and <60% R.H.

Once the package is opened, the products should be used within a week. Otherwise, they should be kept in a damp-proof box with desiccating agent <10% R.H. and apply baking before use.

### Baking:

It is recommended to bake the LED before soldering if the pack has been unsealed for longer than 24hrs. The suggested baking conditions are as followings:

- 60±3°C x 24hrs and <5%RH, taped / reel package.

It's normal to see slight color fading of carrier (light yellow) after baking in process.

### Testing Circuit:



Must apply resistor(s) for protection (over current proof).

### Cleaning:

Use alcohol-based cleaning solvents such as isopropyl alcohol to clean the LED carrier / package. Avoid putting any stress force directly on to the LED lens.

### ESD (Electrostatic Discharge):

Static Electricity or power surge will damage the LED. Use of a conductive wrist band or anti-electrosatic glove is recommended when handling the LED all time. All devices, equipment, machinery, work tables, and storage racks must be properly grounded.

In the events of manual working in process, make sure the devices are well protected from ESD at any time.

**REVISION RECORD:**

---

Version	Date	Summary of Revision
A1.0	01/02/2023	Datasheet set-up.