



BRIGHTTEK
BRIGHTTEK (EUROPE) LIMITED

Brighten Up The World With LED!



ISO/TS 16949:2009



BS EN ISO 14001:2004



QC 080000 IECQ HSPM

PRODUCT DATASHEET



- ▶ PLCC2 Top View
- ▶ 1608 0.55t Series
- ▶ Yellow (585~594nm)

NOY51S66



Release Date: 19 October 2022 Version: A1.2



1608 0.55t Series

RoHS Compliant



AUTOMOTIVE AEC-Q102

FEATURES:

- **Package:** PLCC2 SMT Top View Package
- **Forward Current:** 20mA
- **Forward Voltage (typ.):** 2.0V
- **Luminous Intensity (typ.):** 140mcd@20mA
- **Colour:** Yellow
- **Wavelength:** 585~594nm
- **Viewing angle:** 120°
- **Materials:**
 - Resin: Silicon (White Diffused)
 - L/T Finish: Ag plated
- **Operating Temperature:** -40~+105°C
- **Storage Temperature:** -40~+105°C
- **Grouping parameters:**
 - Forward Voltage
 - Luminous Intensity
 - Dominant Wavelength
- **Soldering methods:** Reflow
- **MSL:** 2a according to J-STD020
- **Packing:** 8mm tape with max.4000pcs /reel, ø180mm (7")

APPLICATIONS:

- Automotive Interior Lighting
- Decorative Lighting
- Back Light for LCD

CHARACTERISTICS:

Absolute Maximum Characteristics (Ta=25°C)

Parameter	Symbol	Ratings	Unit
DC Forward Current	I _F	30	mA
Pulse Forward Current Duty 1/10, Pulse Width 0.1mS	I _{PF}	100	mA
Reverse Voltage	V _R	10	V
Reverse Current @10V	I _R	10	μA
Junction Temperature	T _J	125	°C
Thermal Resistance Junction to Solder Point	R _{THJ-S}	130	°C/W
Thermal Resistance Junction to Ambient Point	R _{THJ-A}	260	°C/W
Electrostatic Discharge (HBM)	ESD	2000	V
Operating Temperature	T _{OPR}	-40~+105	°C
Storage Temperature	T _{STG}	-40~+105	°C
Soldering Temperature	T _{SOL}	260	°C

Electrical & Optical Characteristics (Ta=25°C)

Parameter	Symbol	Values			Unit	Test Condition
		Min.	Typ.	Max.		
Forward Voltage	V _F	1.8	2.0	2.6	V	I _F =20mA
Luminous Intensity	I _v	100	140	---	mcd	I _F =20mA
Dominant Wavelength	λ _D	585	---	594	nm	I _F =20mA
Peak Wavelength	λ _P	---	591	---	nm	I _F =20mA
Spectral Width 50%	Δλ	---	13	---	nm	I _F =20mA
Viewing Angle	2θ _{1/2}	---	120	---	deg	I _F =20mA

- Luminous intensity (I_v) ±10%, Forward Voltage (V_F) ±0.1V, Viewing angle(2θ_{1/2}) ±5°

OUTLINE DIMENSION:

Package Dimension:

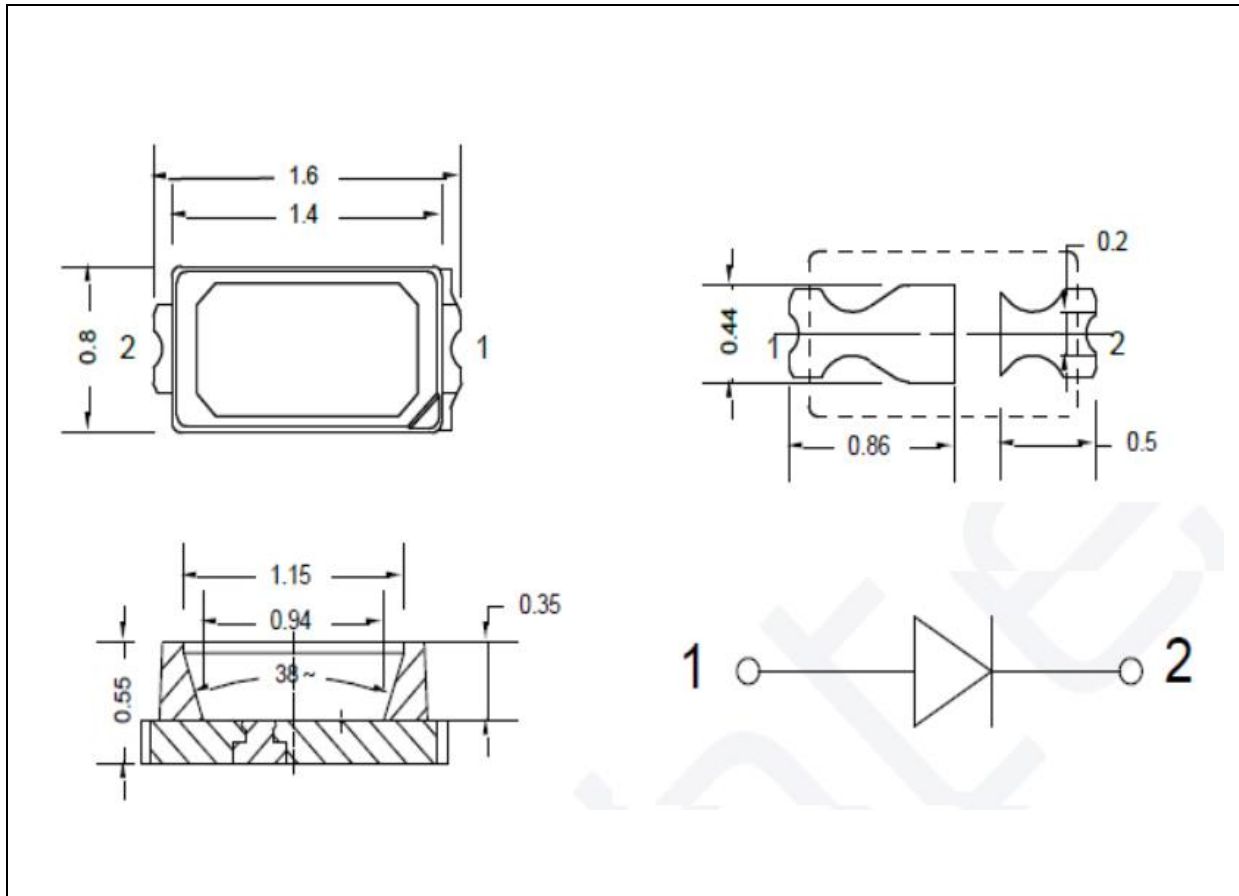

1. All dimensions are in millimetre (mm).
2. Tolerance ± 0.13 mm, unless otherwise noted.

Recommended Soldering Pad Dimension:

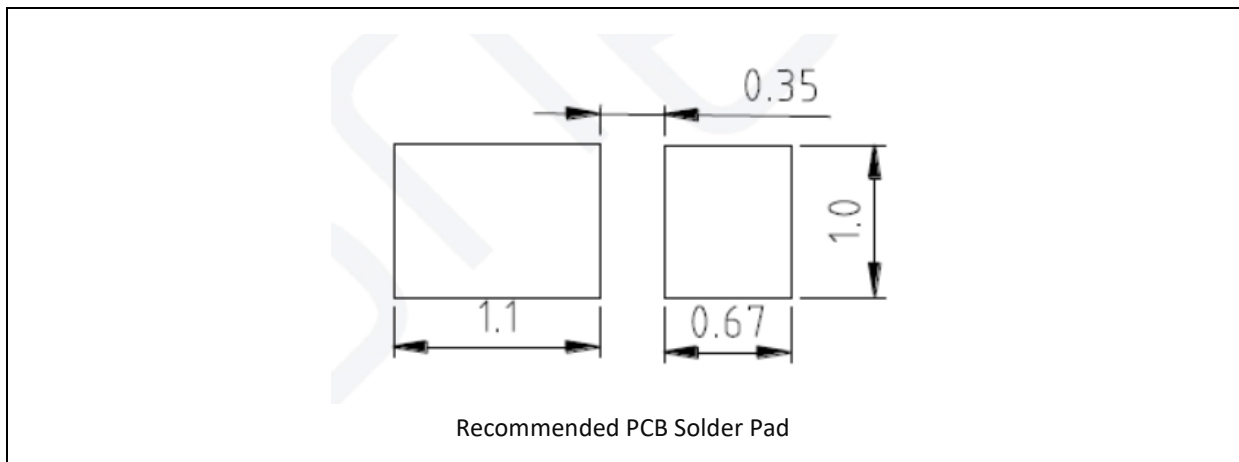

1. Dimensions are in millimetre (mm).
2. Tolerance ± 0.12 mm with angle tolerance $\pm 0.5^\circ$.

BINNING GROUPS:

 Forward Voltage Classifications ($I_F = 20\text{Ma}$):

Code	Min.	Max.	Unit
E	1.8	2.0	V
F	2.0	2.2	
G	2.2	2.4	
H	2.4	2.6	

 Luminous Intensity Classifications ($I_F = 20\text{Ma}$):

Code	Min.	Max.	Unit
12	100	125	mcd
13	125	160	
14	160	200	
15	200	250	

 Dominant Wavelength Classifications ($I_F = 20\text{Ma}$):

Code	Min.	Max.	Unit
Y1	585	588	nm
Y2	588	591	
Y3	591	594	

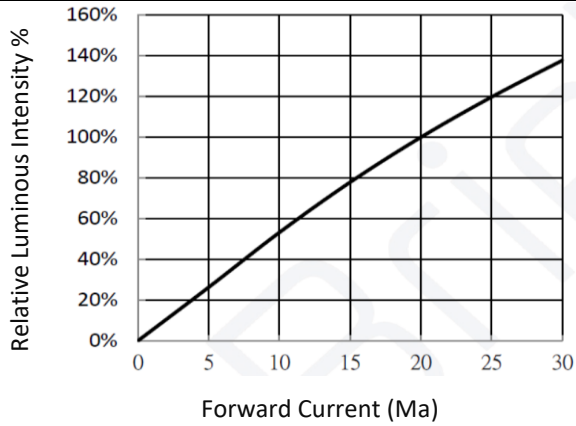
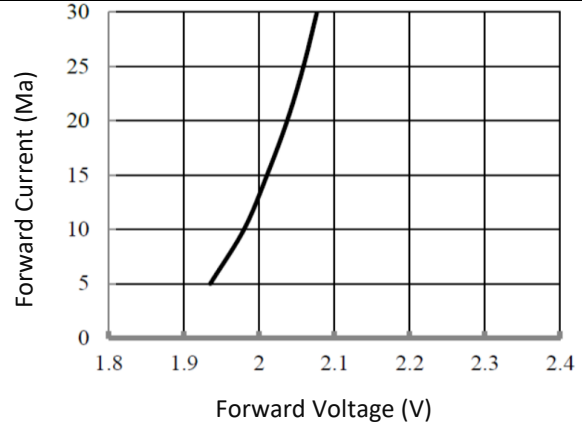
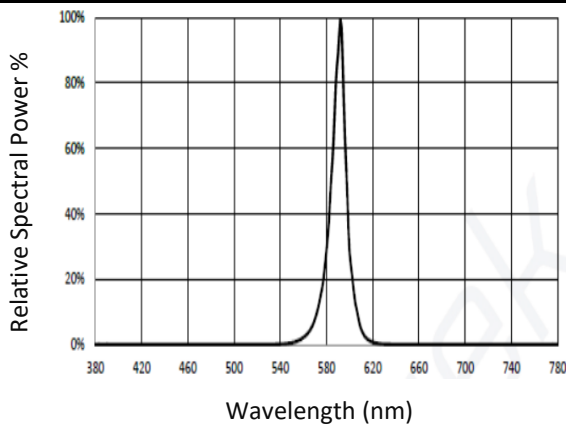
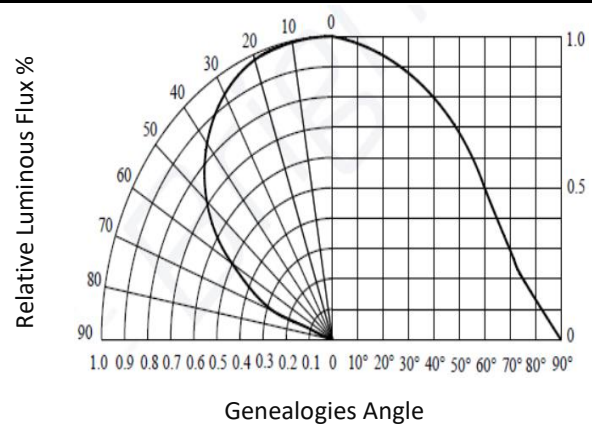
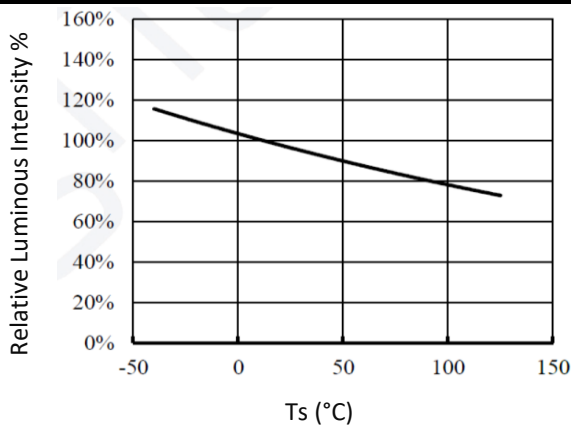
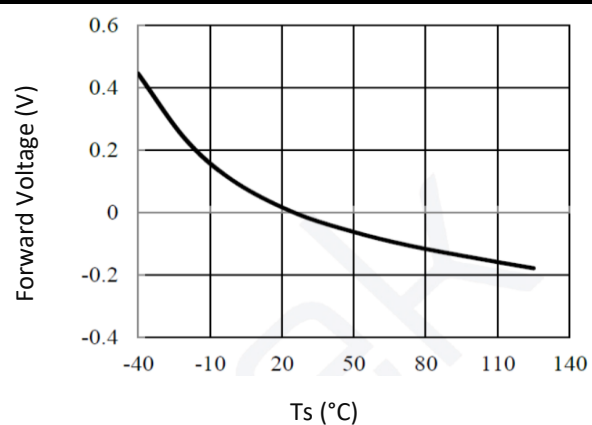
ELECTRO-OPTICAL CHARACTERISTICS:
Relative Luminous Intensity v.s. Forward Current

Forward Current v.s. Forward Voltage

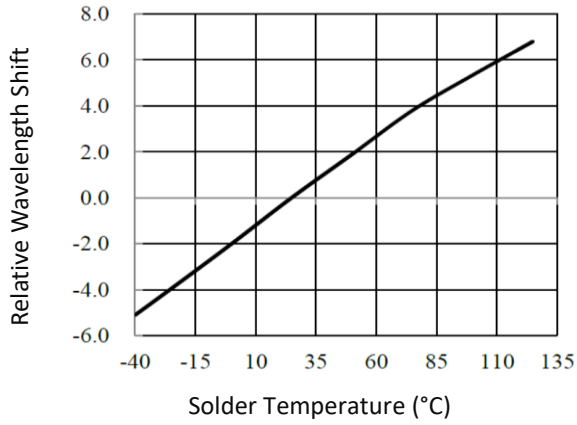
Relative Spectral Power v.s. Wavelength

Directive Radiation

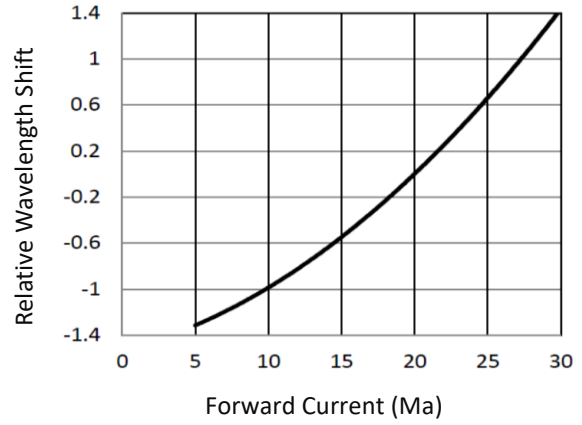
Relative Luminous Intensity v.s. Solder Temp.

Forward Voltage v.s. Solder Temperature

Wavelength Shift v.s. Solder Temperature



Wavelength Shift v.s. Forward Current



Forward Current Derating Curve

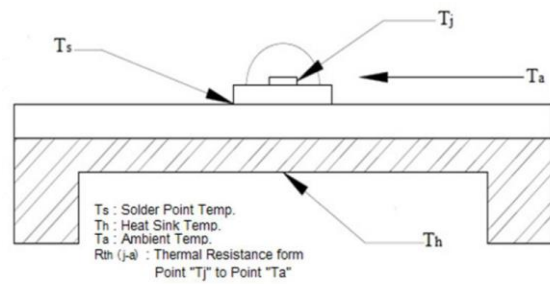
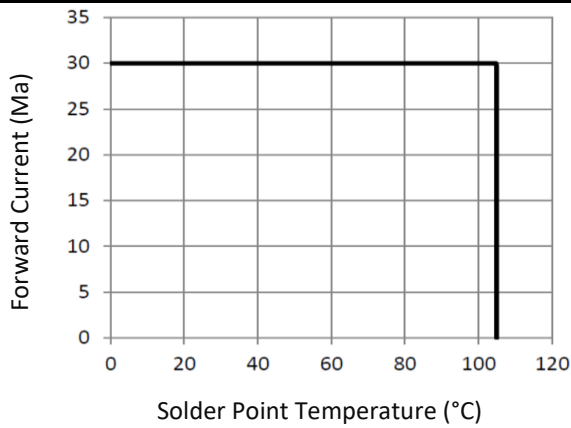

RECOMMENDED SOLDERING PROFILE:

Reflow Lead-free Solder:

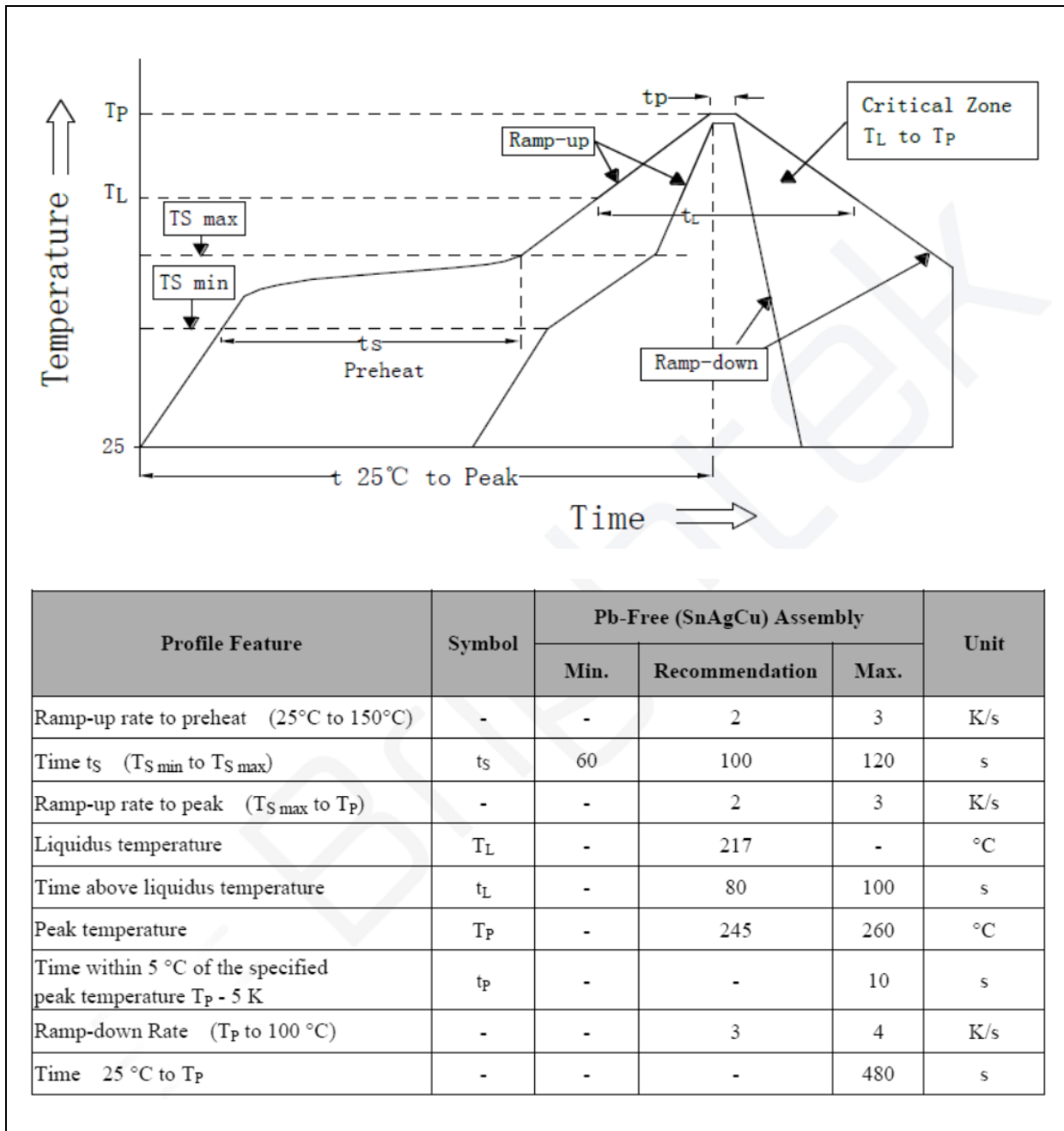

Note:

1. Maximum reflow soldering: 3 times.
2. The recommended reflow temperature is 240°C. The maximum soldering temperature should be limited to 260°C.
3. Before, during, and after soldering, should not apply stress on the components and PCB board.

PACKING SPECIFICATION:

Reel Dimension:

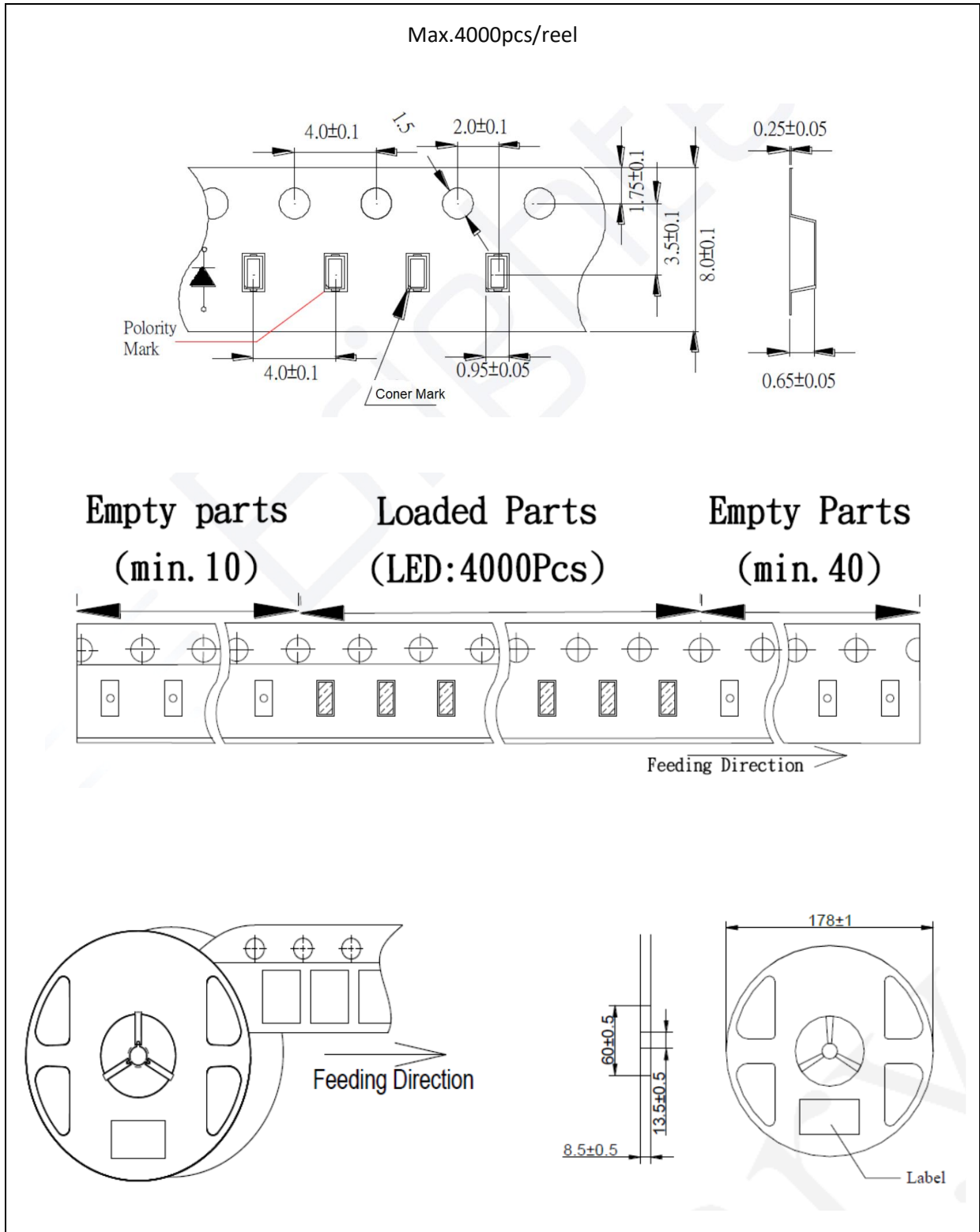

PRECAUTIONS OF USE:

Storage:

It is recommended to store the products in the following conditions:

- Humidity: 60% R.H. Max.
- Temperature: 5°C~30°C (41°F ~86°F).

Shelf life in sealed bag: 12 months at 5°C~30°C and <60% R.H.

Once the package is opened, the products should be used within a week. Otherwise, they should be kept in a damp-proof box with desiccating agent <10% R.H. and apply baking before use.

Baking:

It is recommended to bake the LED before soldering if the pack has been unsealed for longer than 24hrs. The suggested baking conditions are as followings:

- 60±3°C x 6hrs and <5%RH, taped / reel package.

It's normal to see slight color fading of carrier (light yellow) after baking in process.

Testing Circuit:



Must apply resistor(s) for protection (over current proof).

Cleaning:

Use alcohol-based cleaning solvents such as isopropyl alcohol to clean the LED carrier / package. Avoid putting any stress force directly on to the LED lens.

ESD (Electrostatic Discharge):

Static Electricity or power surge will damage the LED. Use of a conductive wrist band or anti-electrostatic glove is recommended when handling the LED all time. All devices, equipment, machinery, work tables, and storage racks must be properly grounded.

In the events of manual working in process, make sure the devices are well protected from ESD at any time.

REVISION RECORD:

Version	Date	Summary of Revision
A1.0	28/04/2020	Datasheet set-up.
A1.1	22/04/2022	New datasheet format.
A1.2	19/10/2022	Revise polarity and package dimensions.