



BRIGHTTEK
BRIGHTTEK (EUROPE) LIMITED

Brighten up The World With LED!



ISO/TS 16949:2009



BS EN ISO 14001:2004



QC 080000 IECQ HSPM

PRODUCT DATASHEET



- ▶ PLCC2 Top View SMD
- ▶ 2214 1.3t
- ▶ Yellow (590nm)

NOY49S17



Release Date: 11 August 2020 Version: A1.0



2214 1.3t Series

2214 1.3t Series



FEATURES:

- **Package:** PLCC2 Single Colour Top View SMD
- **Forward Current:** 20mA
- **Forward Voltage (typ.):** 2.0V
- **Luminous Intensity (typ.):** 770mcd @20mA
- **Colour:** Yellow
- **Wavelength:** 590nm
- **Viewing angle:** 120°
- **Materials:**
 - Die: AlInGaP
 - Resin: Silicone (Water Clear)
 - Finishing: Ag plated
- **Operating Temperature:** -40~+105°C
- **Storage Temperature:** -40~+105°C
- **ESD (HBM):** 2KV
- **Grouping parameters:**
 - Forward voltage
 - Luminous intensity
 - Dominant wavelength
- **Soldering methods:** Reflow
- **MSL:** acc. to JEDEC Level 2a
- **Packing:** 8mm tape with max.3000/reel, ϕ 180mm (7")

APPLICATIONS:

- Backlighting
- Indication Light
- Switch light
- Dashboard
- Automotive
- Decoration Lighting

CHARACTERISTICS:

Absolute Maximum Characteristics (Ta=25°C)

Parameter	Symbol	Ratings	Unit
Forward Current	I _F	30	mA
Peak Forward Current Duty 1/10; width 0.1ms	I _{FP}	100	mA
Reverse Voltage	V _R	10	V
Reverse Current @10V	I _R	10	μA
Junction Temperature	T _j	125	°C
Thermal Resistance Junction to Solder Point	R _{th}	160	°C/W
Operating Temperature	T _{OPR}	-40~+105	°C
Storage Temperature	T _{STG}	-40~+105	°C

Electrical & Optical Characteristics (Ta=25°C)

Parameter	Symbol	Values			Unit	Test Condition
		Min.	Typ.	Max.		
Forward Voltage	V _F	1.7	2.0	2.5	V	I _F =20mA
Luminous Intensity	I _v	460	770	1300	mcd	I _F =20mA
Dominant Wavelength	λ _D	585	---	597	nm	I _F =20mA
Viewing Angle	2θ _{1/2}	---	120	---	deg	I _F =20mA

- Luminous intensity (I_v) ±10%, Forward Voltage (V_F) ±0.1V.

OUTLINE DIMENSION:

Package Dimension:

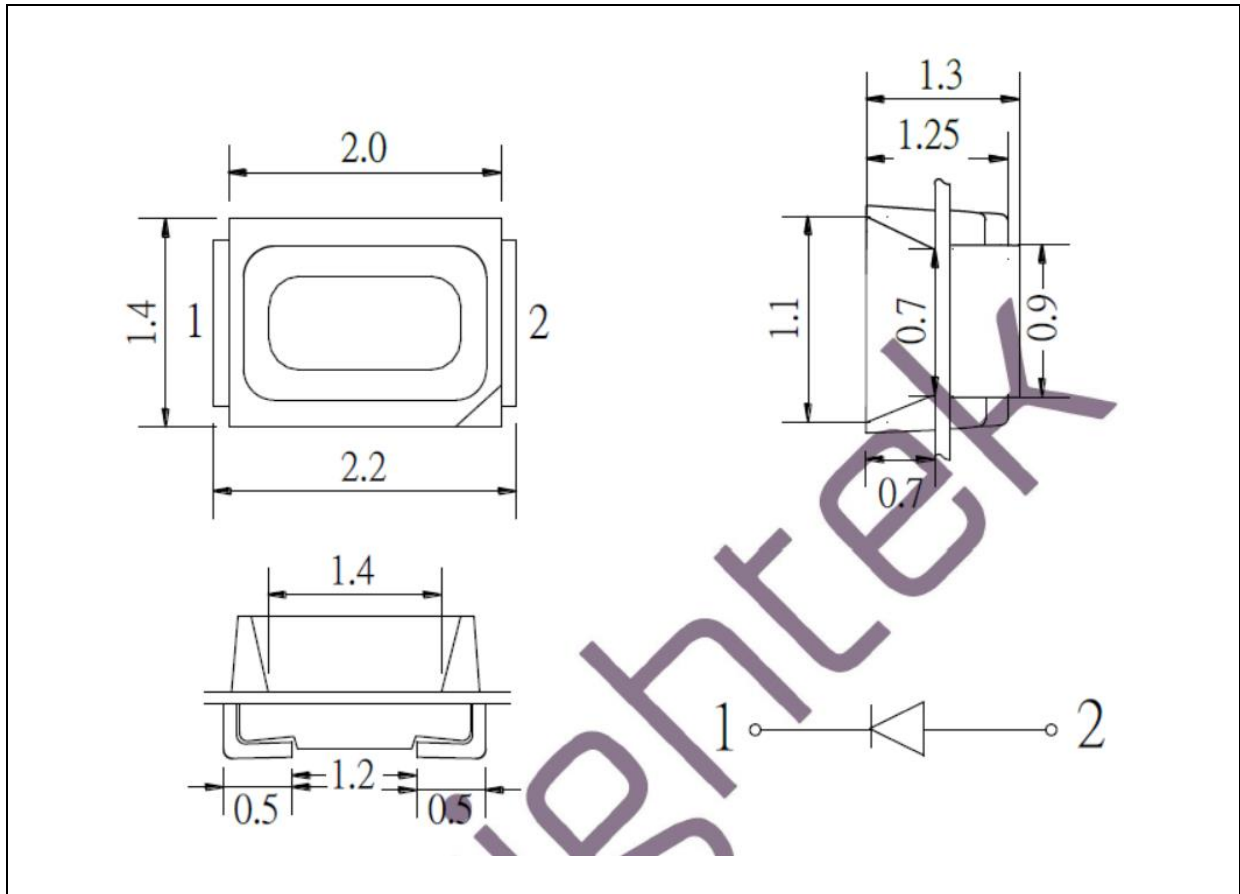

1. All dimensions are in millimetre (mm).
2. Tolerance $\pm 0.2\text{mm}$, unless otherwise noted.

Recommended Soldering Pad Dimension:

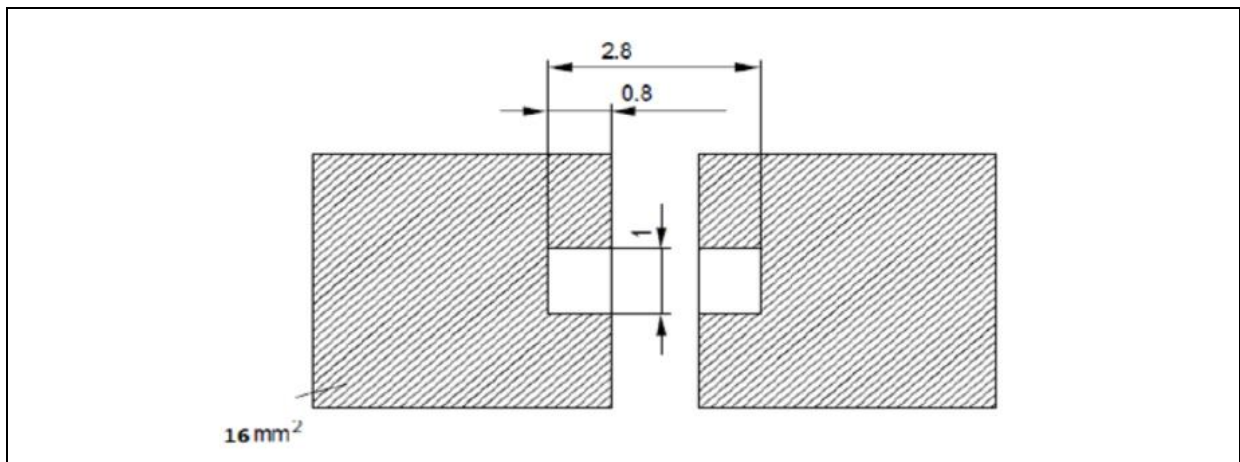

1. Dimensions are in millimetre (mm).
2. Tolerance $\pm 0.1\text{mm}$ with angle tolerance $\pm 0.5^\circ$.

BINNING GROUPS:

 Forward Voltage Classifications ($I_F = 20\text{mA}$):

Code	Min.	Max.	Unit
A	1.7	1.8	V
B	1.8	1.9	
C	1.9	2.0	
D	2.0	2.1	
E	2.1	2.2	
F	2.2	2.3	
G	2.3	2.4	
H	2.4	2.5	

 Luminous Intensity Classifications ($I_F = 20\text{mA}$):

Code	Min.	Max.	Unit
12	460	600	mcd
13	600	780	
14	780	1000	
15	1000	1300	

 Dominant Wavelength Classifications ($I_F = 20\text{mA}$):

Code	Min.	Max.	Unit
C	585	588	nm
D	588	591	
E	591	594	
F	594	597	

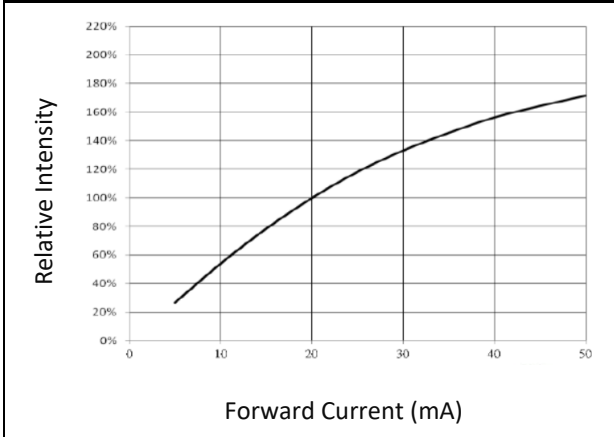
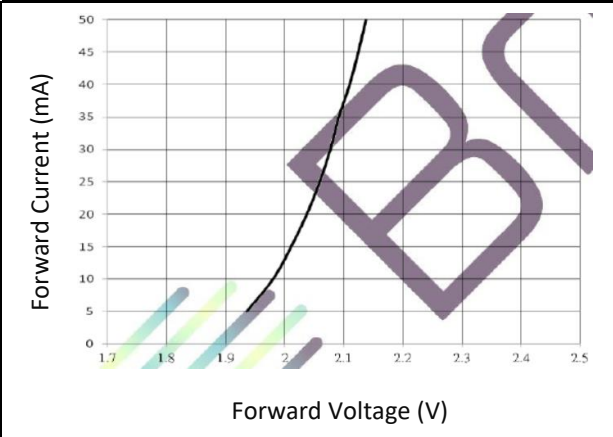
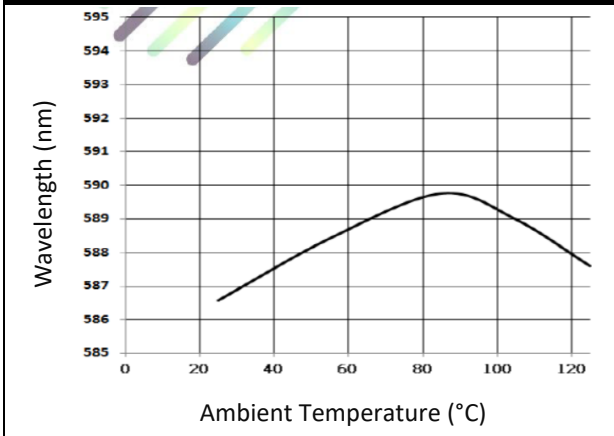
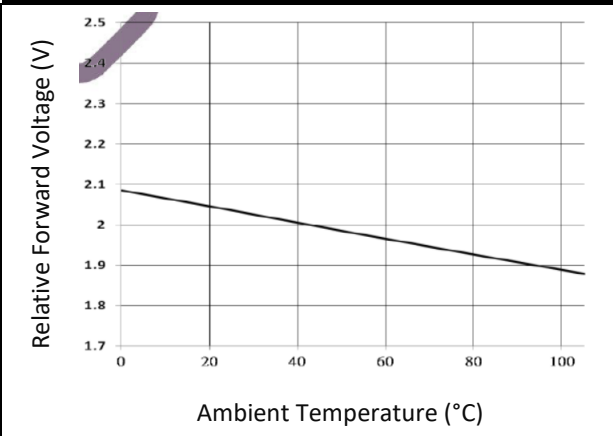
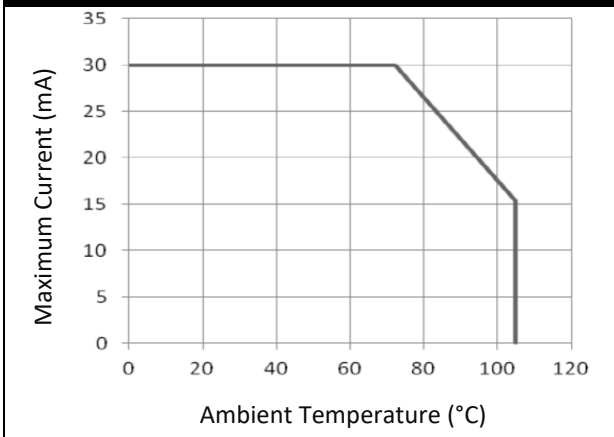
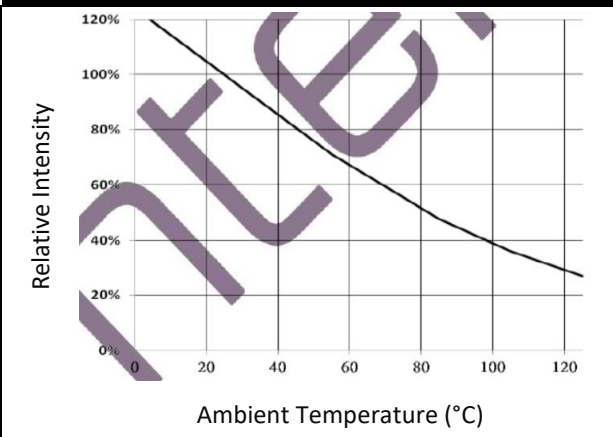
ELECTRO-OPTICAL CHARACTERISTICS:
Relative Intensity v.s. Forward Current

Forward Current v.s. Forward Voltage

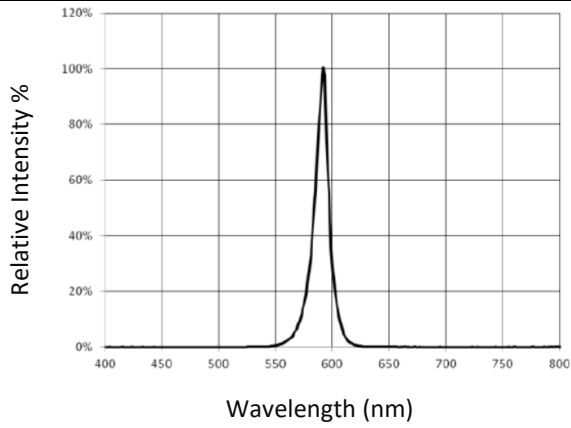
Ambient Temperature v.s. Wavelength

Relative Forward Voltage v.s. Temperature

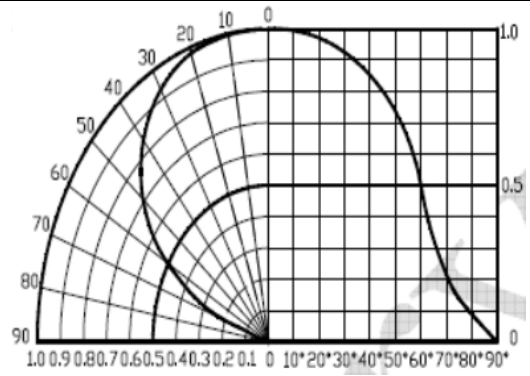
Temperature Derating Chart

Relative Intensity Flux v.s. Ambient Temperature

Relative Intensity v.s. Wavelength



Relative Intensity v.s. Angular Displacement



RECOMMENDED SOLDERING PROFILE:

Reflow solder:

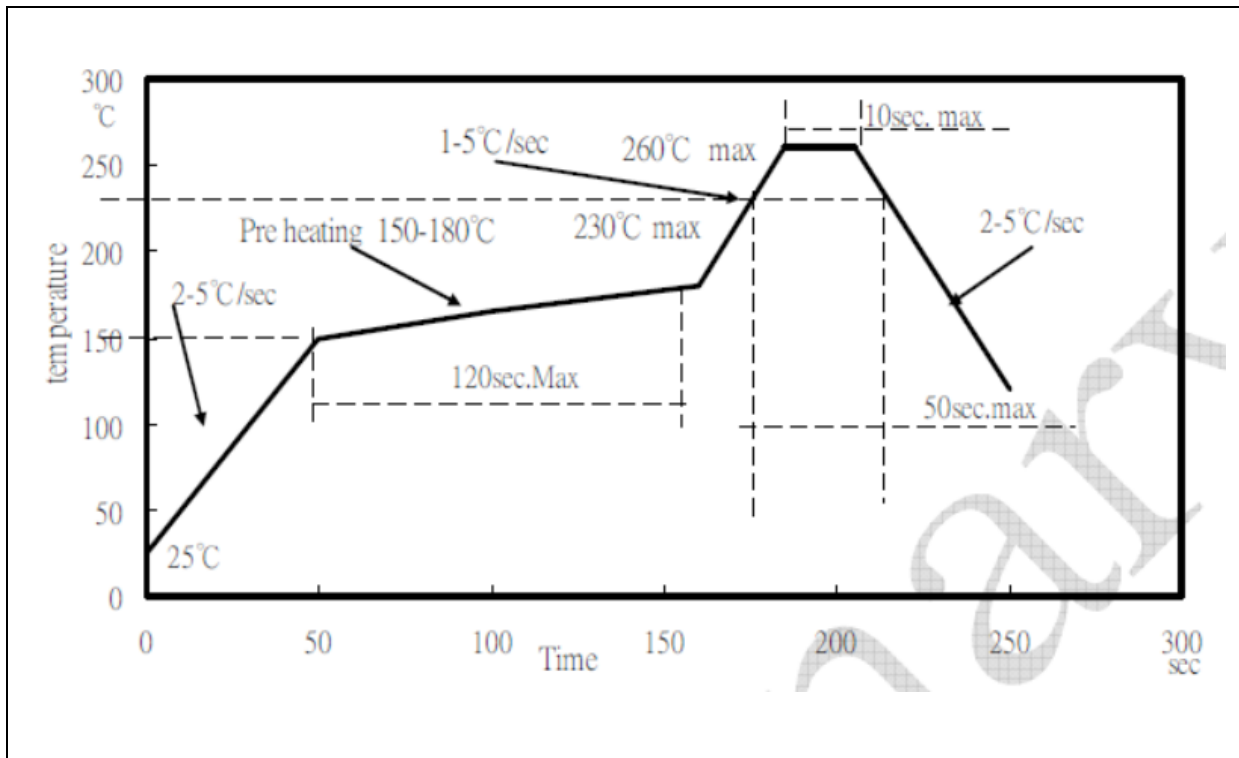

Note:

1. Recommend reflow temperature 240°C. The maximum soldering temperature should be limited to 260°C.
2. Maximum reflow soldering: 3 times.
3. Before, during, and after soldering, should not apply stress on the components and PCB board.

PACKING SPECIFICATION:

Reel Dimension:

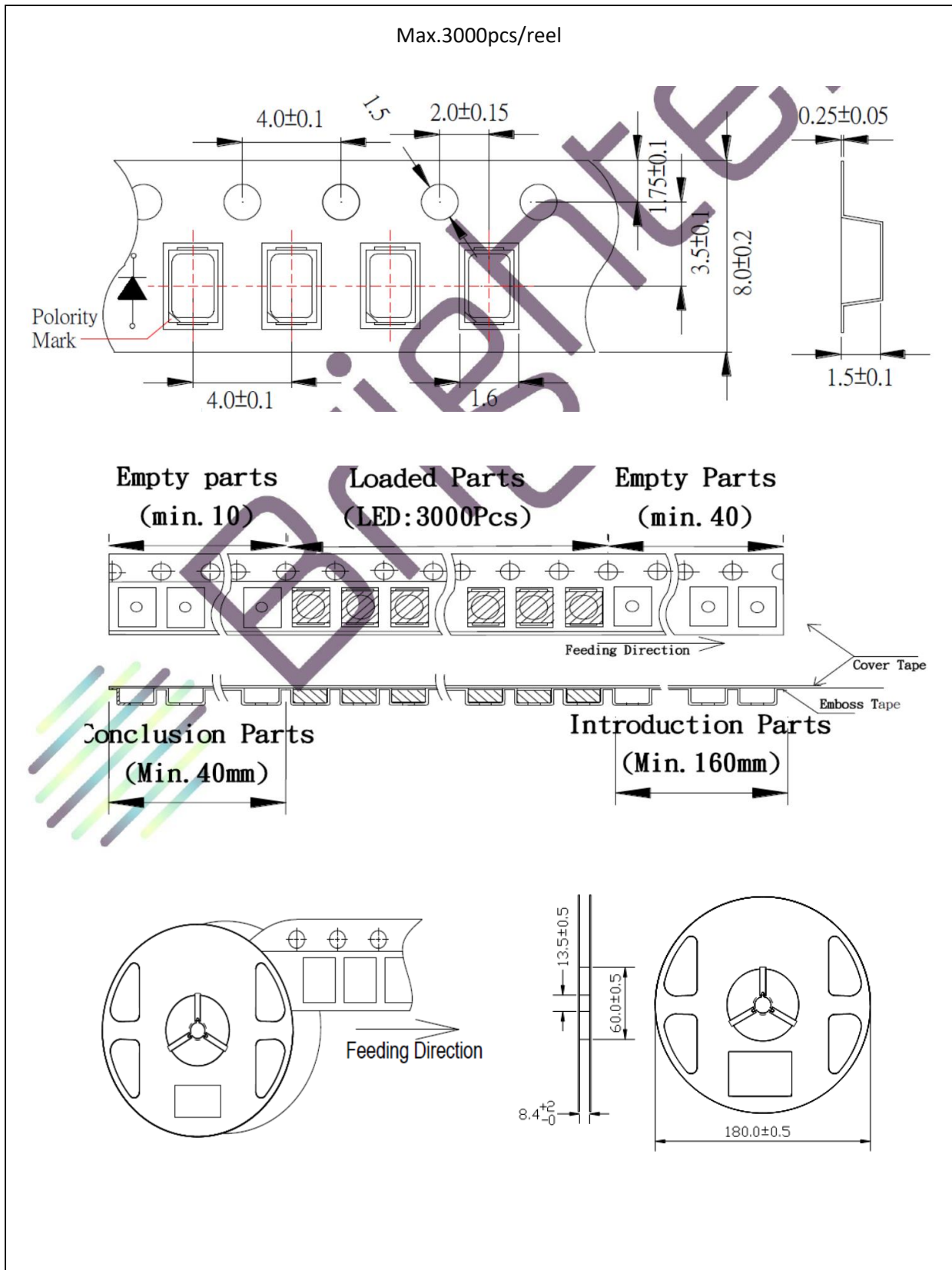

PRECAUTIONS OF USE:

Storage:

It is recommended to store the products in the following conditions:

- Humidity: 60% R.H. Max.
- Temperature: 5°C~30°C (41°F ~86°F).

Shelf life in sealed bag: 12 months at 5°C~30°C and <60% R.H.

Once the package is opened, the products should be used within 4 weeks. Otherwise, they should be kept in a damp-proof box with desiccating agent <10% R.H. and apply baking before use.

Baking:

It is recommended to bake the LED before soldering if the pack has been unsealed for longer than 24hrs.

The suggested baking conditions are as followings:

- 60±3°C x 6hrs and <5%RH, taped / reel package.

It's normal to see slight color fading of carrier (light yellow) after baking in process.

Testing Circuit:

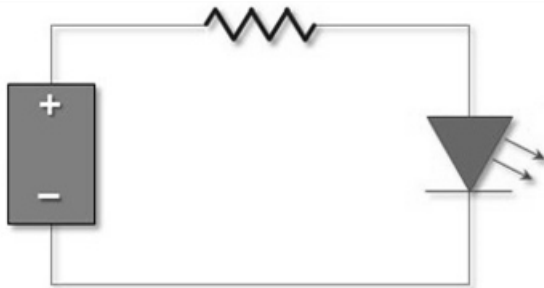

Must apply resistor(s) for protection (over current proof).

Cleaning:

Use alcohol-based cleaning solvents such as isopropyl alcohol to clean the LED carrier / package. Avoid putting any stress force directly on to the LED lens.

ESD (Electrostatic Discharge):

Static Electricity or power surge will damage the LED. Use of a conductive wrist band or anti-electrostatic glove is recommended when handling the LED all time. All devices, equipment, machinery, work tables, and storage racks must be properly grounded.

In the events of manual working in process, make sure the devices are well protected from ESD at any time.

REVISION RECORD:

Version	Date	Summary of Revision
A1.0	11/08/2020	Datasheet set-up.