



BRIGHTTEK
BRIGHTTEK (EUROPE) LIMITED

Brighten Up The World With LED!



ISO/TS 16949:2009



BS EN ISO 14001:2004



QC 080000 IECQ HSPM

PRODUCT DATASHEET



- ▶ Ceramic SMD
- ▶ 3535 2.3t
- ▶ Natural White 5000K

NOW56S33 (CRI 90)



Release Date: 03 March 2024 Version: A1.4



3535 Ceramic Series



FEATURES:

- **Package:** Top View Ceramic Package
- **Forward Current:** 350~1000mA
- **Forward Voltage (typ.):** 2.9V
- **Luminous Flux (typ.):** 156lm@350mA
- **Colour:** Natural White
- **Colour Temperature (typ.):** 5000K
- **Viewing Angle:** 120°
- **Materials:**
 - Die: InGaN
 - Resin: Silicon (Yellow Diffused)
 - Package: Ceramic
- **Operating Temperature:** -40~+105°C
- **Storage Temperature:** -40~+85°C
- **Electrostatics Discharge:** 1000V
- **Grouping Parameters:**
 - Forward Voltage
 - Luminous Flux
 - CIE Chromaticity
- **Soldering Methods:** Reflow Soldering
- **MSL Level:** MSL3 according to J-STD020
- **Packing:** 12mm tape with max.900/reel, ϕ 165mm (6.5")

APPLICATIONS:

- General Lighting
- Portable Lighting
- Commercial Lighting
- Indoor Lighting
- Architecture Lighting
- High Bay Light

CHARACTERISTICS:

Absolute Maximum Characteristics (Ta=25°C)

Parameter	Symbol	Ratings	Unit
DC Forward Current	I _F	1000	mA
Pulse Forward Current (Duty 1/10, width≤100μS)	I _{PF}	1500	mA
Power Dissipation	P _D	3400	mW
Reverse Voltage	V _R	5	V
Reverse Current @10V	I _R	10	μA
Junction Temperature	T _j	125	°C
Electrostatic Discharge	ESD	1000	V
Thermal Resistance (Junction to Solder Point)	R _{th(j-sp)}	5	°C/W
Operating Temperature	T _{OPR}	-40~+105	°C
Storage Temperature	T _{STG}	-40~+85	°C
Soldering Temperature	T _{SOL}	230/260 for 10S	°C
Colour Rendering Index	CRI	min. 90 typ. 92	---

1. R_{th(j-sp)} is the thermal resistance from LED junction to solder point on MCPCB with electrical power.

CHARACTERISTICS:

Electrical & Optical Characteristics (Ta=25°C)

Parameter	Symbol	Values			Unit	Test Condition
		Min.	Typ.	Max.		
Forward Voltage	V_F	2.6	2.9	3.4	V	$I_F=350\text{mA}$
Luminous Flux ($T_j=25^\circ\text{C}$)	Φ_V	130	156	---	lm	$I_F=350\text{mA}$
		---	289	---		$I_F=700\text{mA}$
Luminous Flux ($T_j=85^\circ\text{C}$)	Φ_V	---	140	---	lm	$I_F=350\text{mA}$
		---	257	---		$I_F=700\text{mA}$
Chromaticity Coordinates	X	0.3361	---	0.3571	---	$I_F=350\text{mA}$
	Y	0.3245	---	0.3907		
Colour Temperature	CCT	---	5000	---	K	$I_F=350\text{mA}$
Viewing Angle	$2\theta_{1/2}$	---	120	---	deg	$I_F=350\text{mA}$

1. Luminous flux (Φ_V) $\pm 10\%$, Forward Voltage (V_F) $\pm 0.1\text{V}$, CRI ± 2

OUTLINE DIMENSION:

Package Dimension:

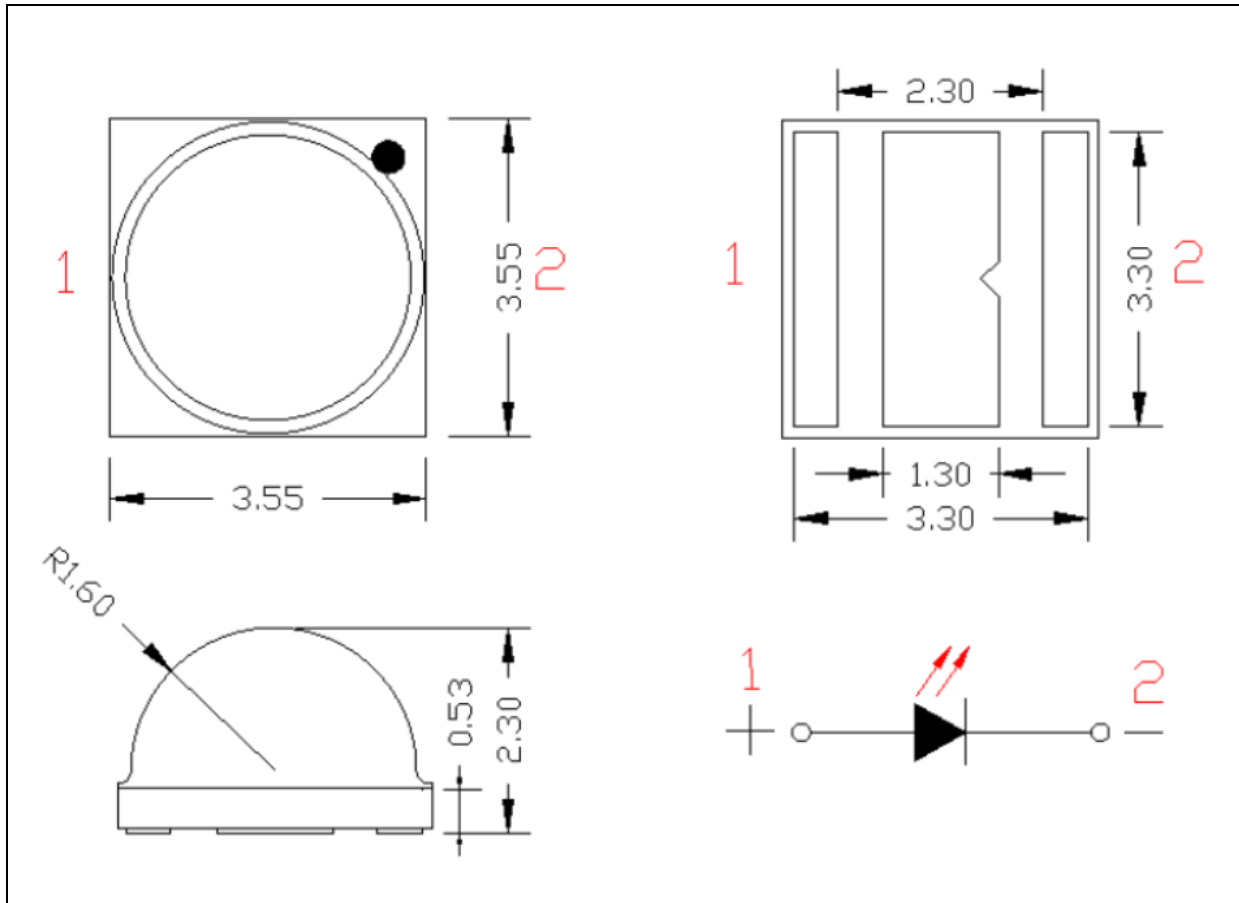

1. All dimensions are in millimetre (mm).
2. Tolerance $\pm 0.2\text{mm}$, unless otherwise noted.

Recommended Soldering Pad Dimension:

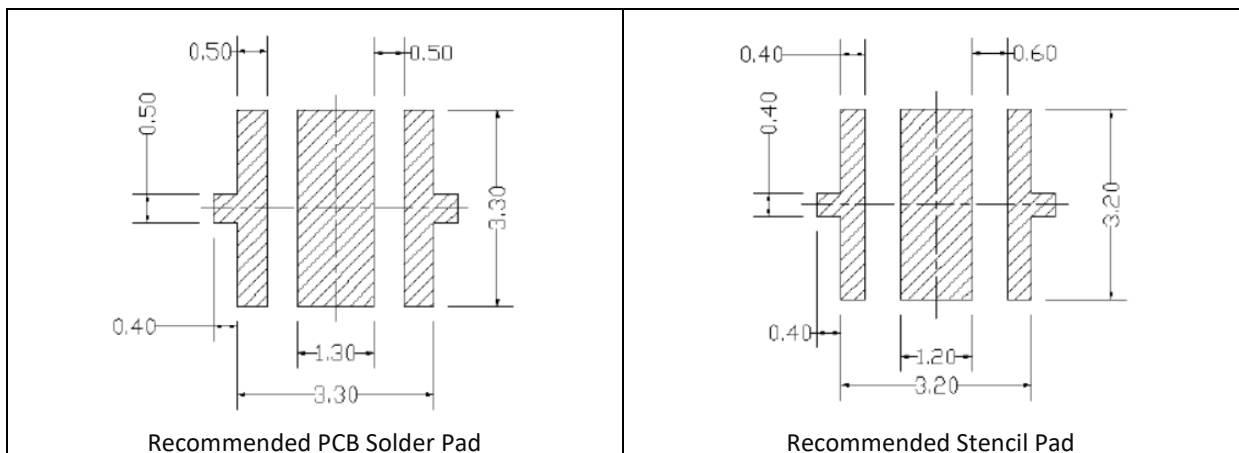

1. Dimensions are in millimetre (mm).
2. Tolerance $\pm 0.1\text{mm}$ with angle tolerance $\pm 0.5^\circ$.

BINNING GROUPS:

 Forward Voltage Classifications ($I_F = 350\text{mA}$):

Code	Min.	Max.	Unit
G3	2.6	2.8	V
H3	2.8	3.0	
J3	3.0	3.2	
K3	3.2	3.4	

 Luminous Flux Classifications ($I_F = 350\text{mA}$):

Code	Min.	Max.	Unit
2F	130	139	lm
2G	139	148	
2H	148	156	
2J	156	164	
2K	164	172	

CIE CHROMATICITY DIAGRAM:

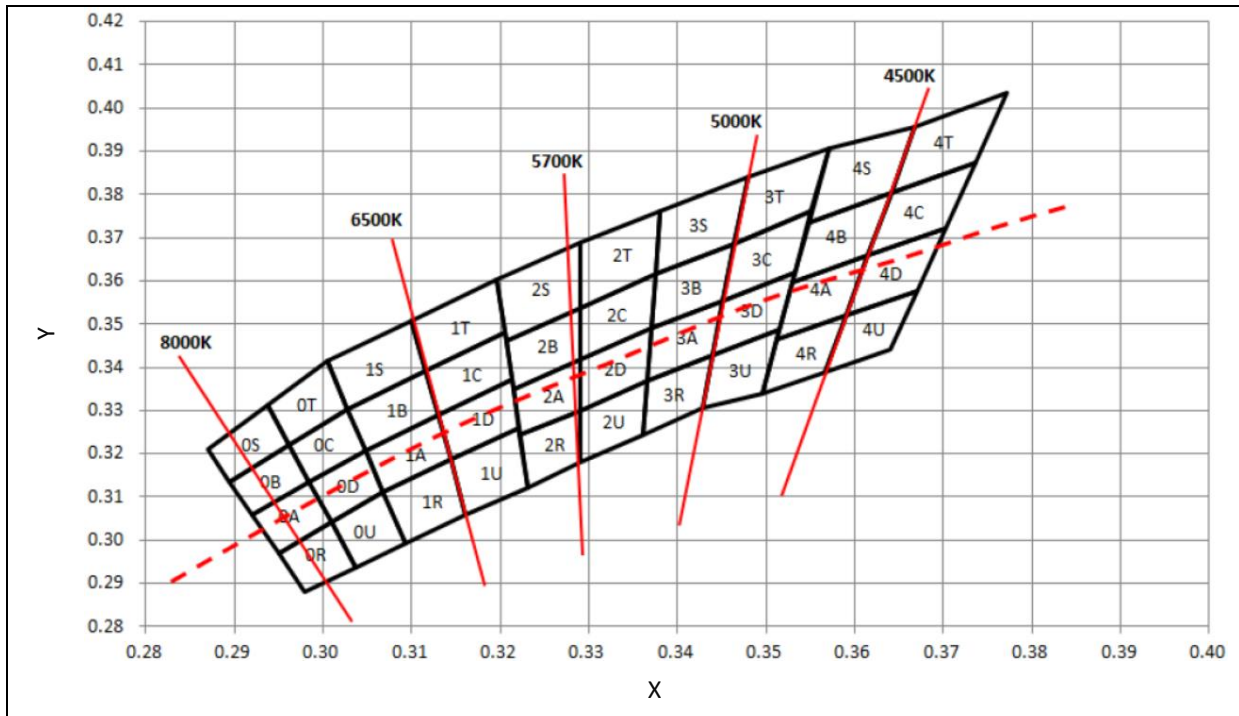

Chromaticity Coordinates Classifications ($I_F = 350\text{mA}$):

	1		2		3		4	
	X	Y	X	Y	X	Y	X	Y
3A	0.3371	0.3490	0.3451	0.3554	0.3440	0.3427	0.3366	0.3369
3B	0.3376	0.3616	0.3463	0.3687	0.3451	0.3554	0.3371	0.3490
3C	0.3463	0.3687	0.3551	0.3760	0.3533	0.3620	0.3451	0.3554
3D	0.3451	0.3554	0.3533	0.3620	0.3515	0.3487	0.3440	0.3427
3R	0.3366	0.3369	0.3440	0.3428	0.3429	0.3307	0.3361	0.3245
3S	0.3381	0.3762	0.3480	0.3840	0.3463	0.3687	0.3376	0.3616
3T	0.3480	0.3840	0.3571	0.3907	0.3551	0.3760	0.3463	0.3687
3U	0.3440	0.3428	0.3515	0.3487	0.3495	0.3339	0.3429	0.3307

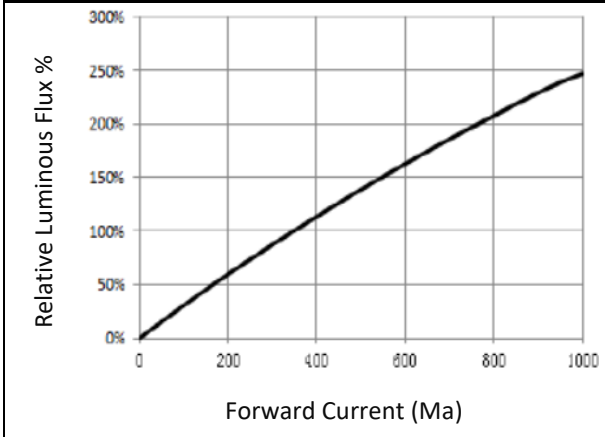
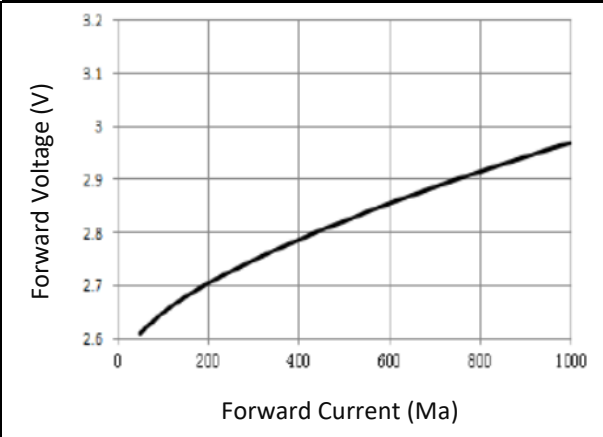
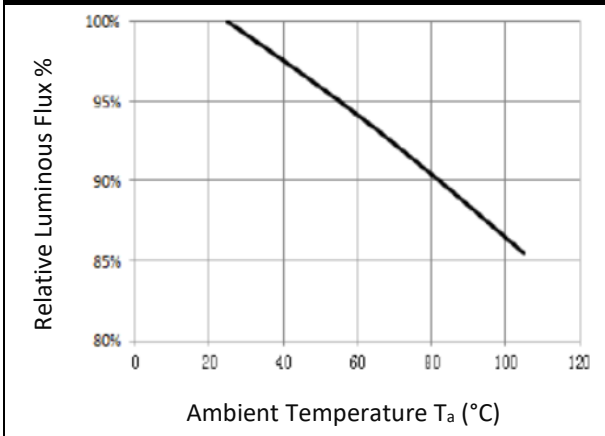
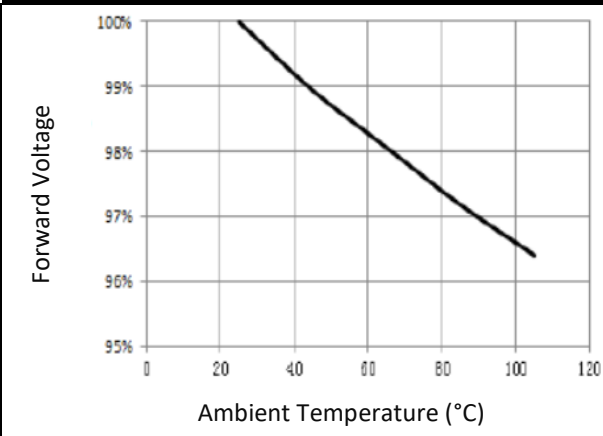
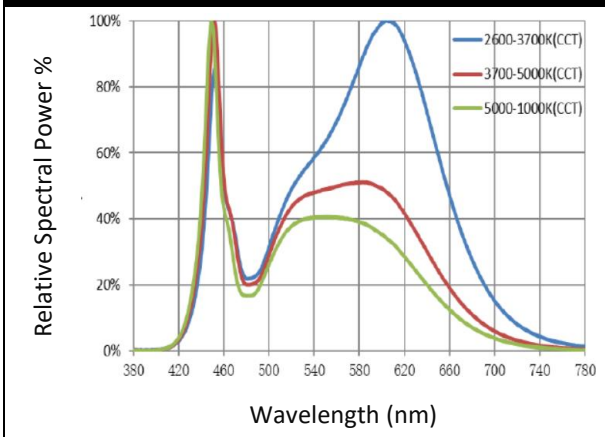
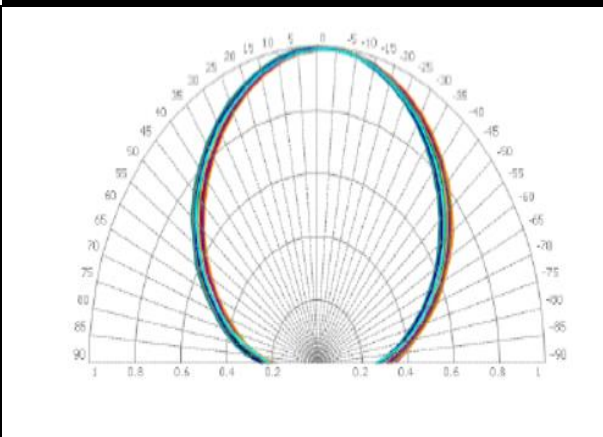
ELECTRO-OPTICAL CHARACTERISTICS:
Relative Luminous Flux v.s. Forward Current

Forward Current v.s. Forward Voltage

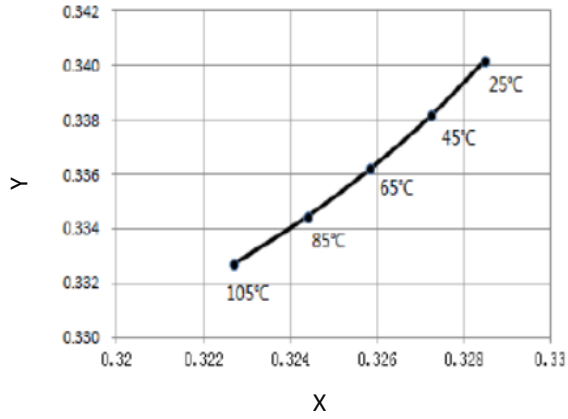
Relative Luminous Flux v.s. Ambient Temp.

Forward Voltage v.s. Ambient Temp.

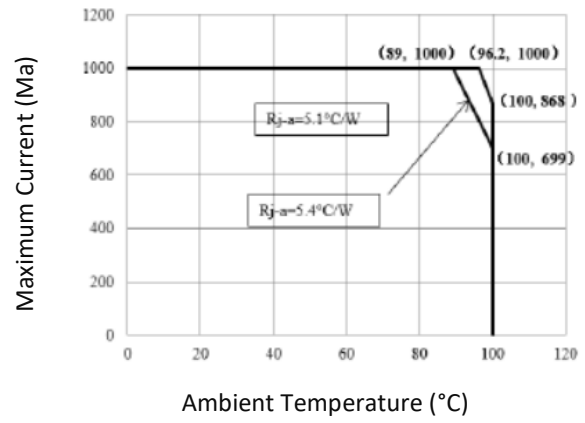
Relative Spectral Power v.s. Wavelength

Directive Radiation

Ambient Temperature v.s. CIE X, Y Shift



Forward Current Derating Curve



RECOMMENDED SOLDERING PROFILE:

Reflow Lead-free Solder:

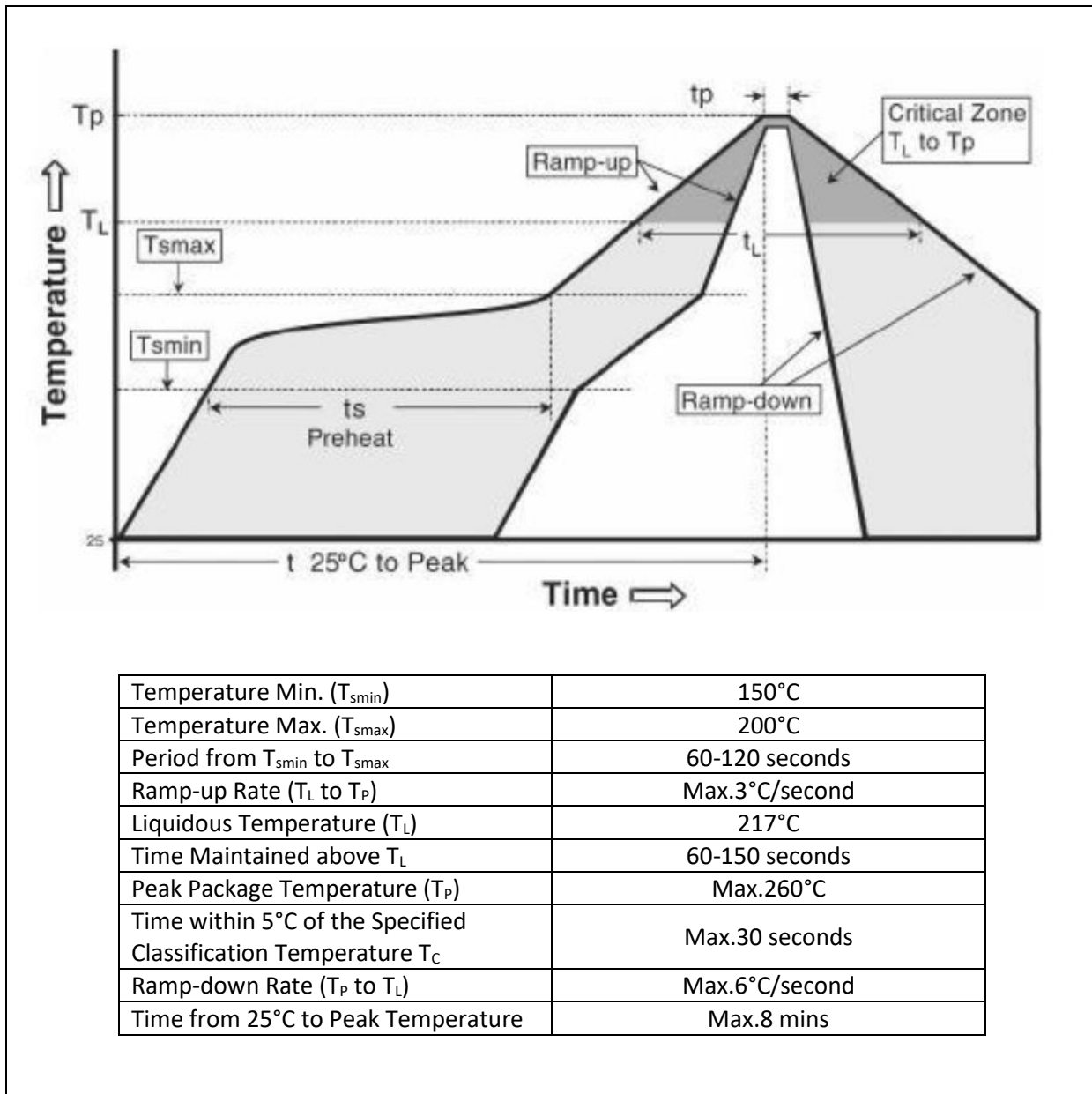

Note:

1. Maximum reflow soldering: 2 times.
2. Before, during, and after soldering, should not apply stress on the components and PCB board.
3. Recommended soldering temperature: 240°C. The maximum soldering temperature should be limited to 260°C for max. 10seconds.

PACKING SPECIFICATION:

Reel Dimension:

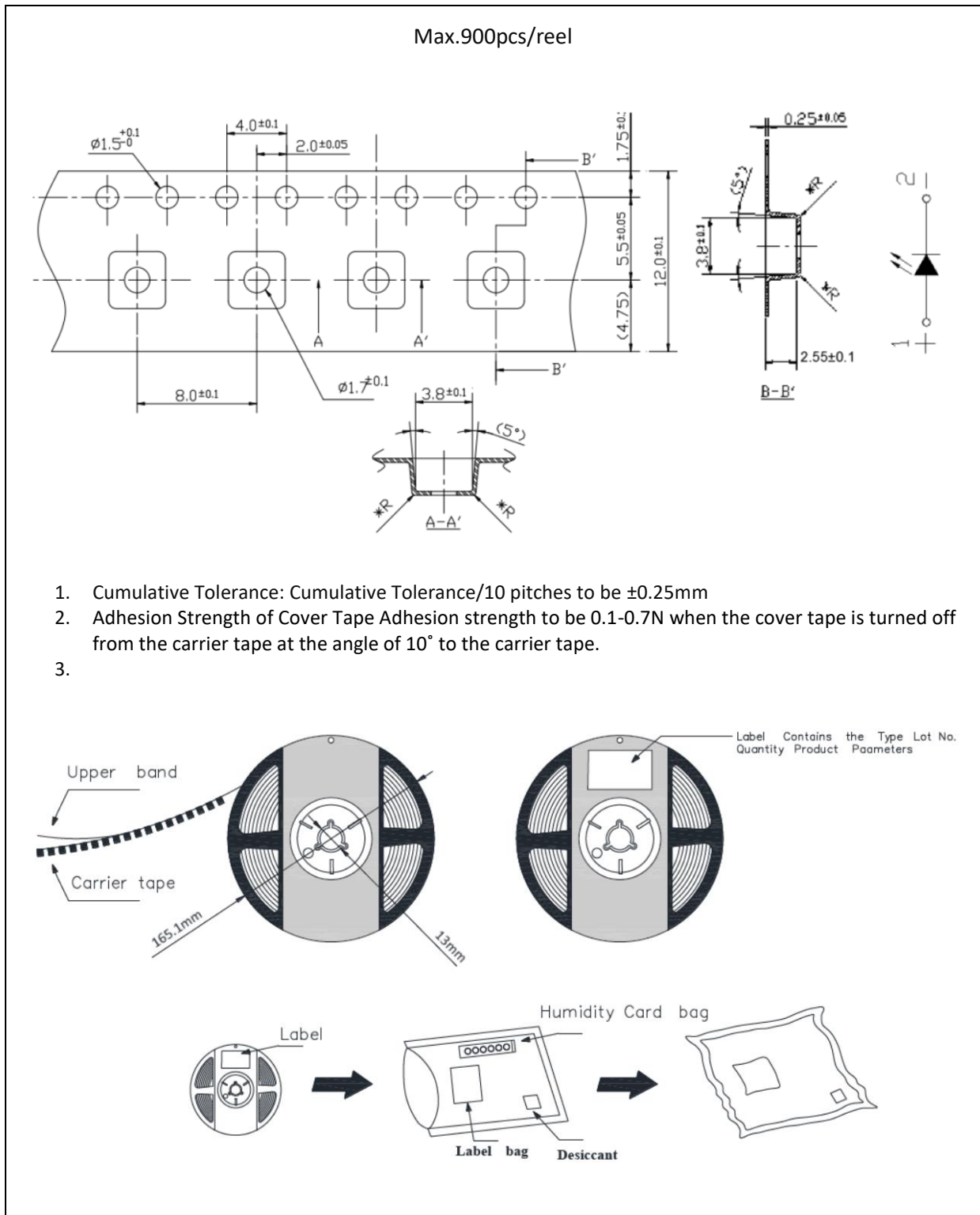

PRECAUTIONS OF USE:

Storage:

It is recommended to store the products in the following conditions:

- Humidity: 60% R.H. Max.
- Temperature: 5°C~30°C (41°F ~86°F).

Shelf life in sealed bag: 12 months at 5°C~30°C and <60% R.H.

Once the package is opened, the products should be used within a week. Otherwise, they should be kept in a damp-proof box with desiccating agent <10% R.H. and apply baking before use.

Baking:

It is recommended to bake the LED before soldering if the pack has been unsealed for longer than 24hrs. The suggested baking conditions are as followings:

- 60±5°C x 24hrs and <5%RH, taped / reel package.

It's normal to see slight color fading of carrier (light yellow) after baking in process.

Testing Circuit:

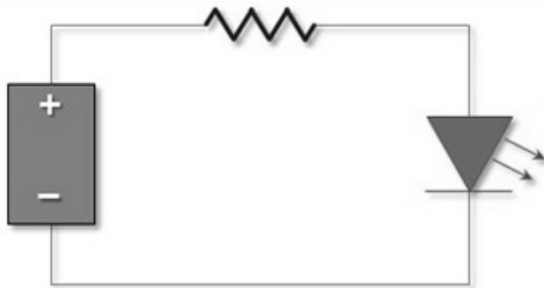

Must apply resistor(s) for protection (over current proof).

Cleaning:

Use alcohol-based cleaning solvents such as isopropyl alcohol to clean the LED carrier / package. Avoid putting any stress force directly on to the LED lens.

ESD (Electrostatic Discharge):

Static Electricity or power surge will damage the LED. Use of a conductive wrist band or anti-electrostatic glove is recommended when handling the LED all time. All devices, equipment, machinery, work tables, and storage racks must be properly grounded.

In the events of manual working in process, make sure the devices are well protected from ESD at any time.

REVISION RECORD:

Version	Date	Summary of Revision
A1.0	24/09/2020	Datasheet set-up.
A1.1	22/03/2022	New datasheet format.
A1.2	23/03/2022	Revise temperature range.
A1.3	07/09/2023	Revised bin table.
A1.4	03/03/2024	Add 700mA typical lumen information.