



**BRIGHTTEK**  
BRIGHTTEK (EUROPE) LIMITED

*Brighten up The World With LED!*



ISO/TS 16949:2009



BSI  
BS EN ISO 14001:2004



QC 800000 IECQ HSP98

## PRODUCT DATASHEET



- ▶ PLCC2 Top View
- ▶ 1608 0.55t Series
- ▶ Sky White

Release Date: 22 April 2022 Version: A1.1

# NOW51S65-5MA



## 1608 0.55t Series

**RoHS**  
Compliant



**AUTOMOTIVE**  
AEC-Q102

### FEATURES:

- **Package:** PLCC2 SMT Top View Package
- **Forward Current:** 5~20mA
- **Forward Voltage (typ.):** 2.8V
- **Luminous Intensity (typ.):** 180mcd@5mA; 630mcd@20mA
- **Colour:** Sky White
- **Viewing angle:** 120°
- **Materials:**
  - Resin: Silicon (Yellow Diffused)
  - L/T Finish: Ag plated
- **Operating Temperature:** -40~+105°C
- **Storage Temperature:** -40~+105°C
- **Grouping parameters:**
  - Forward Voltage
  - Luminous Intensity
  - CIE Chromaticity
- **Soldering methods:** Reflow
- **Preconditioning:** MSL2a according to J-STD020
- **Packing:** 8mm tape with max.4000pcs /reel, ø180mm (7")

### APPLICATIONS:

- Automotive Interior Lighting
- Decorative Lighting
- Back Light for LCD

## CHARACTERISTICS:

### Absolute Maximum Characteristics (Ta=25°C)

Parameter	Symbol	Ratings	Unit
DC Forward Current	I <sub>F</sub>	30	mA
Pulse Forward Current Duty 1/10, Pulse Width 0.1mS	I <sub>PF</sub>	100	mA
Reverse Voltage	V <sub>R</sub>	5	V
Reverse Current @5V	I <sub>R</sub>	10	μA
Junction Temperature	T <sub>j</sub>	125	°C
Thermal Resistance Junction to Solder Point	R <sub>THJ-S</sub>	130	°C/W
Thermal Resistance Junction to Ambient Point	R <sub>THJ-A</sub>	260	°C/W
Electrostatic Discharge (HBM)	ESD	2000	V
Operating Temperature	T <sub>OPR</sub>	-40~+105	°C
Storage Temperature	T <sub>STG</sub>	-40~+105	°C
Soldering Temperature	T <sub>SOL</sub>	260	°C

### Electrical & Optical Characteristics (Ta=25°C)

Parameter	Symbol	Values			Unit	Test Condition
		Min.	Typ.	Max.		
Forward Voltage	V <sub>F</sub>	2.4	2.8	3.2	V	I <sub>F</sub> =5mA
Luminous Intensity	I <sub>v</sub>	120	180	---	mcd	I <sub>F</sub> =5mA
Chromaticity Coordinates	X	---	0.1770	---	---	I <sub>F</sub> =5mA
	Y	---	0.1550	---		
Peak Wavelength	λ <sub>P</sub>	---	464	---	nm	I <sub>F</sub> =5mA
Spectral Width 50%	Δλ	---	22	---	nm	I <sub>F</sub> =5mA
Viewing Angle	2θ <sub>1/2</sub>	---	120	---	deg	I <sub>F</sub> =5mA

1. Luminous intensity (I<sub>v</sub>) ±10%, Forward Voltage (V<sub>F</sub>) ±0.1V, Viewing angle(2θ<sub>1/2</sub>) ±5°

## OUTLINE DIMENSION:

Package Dimension:

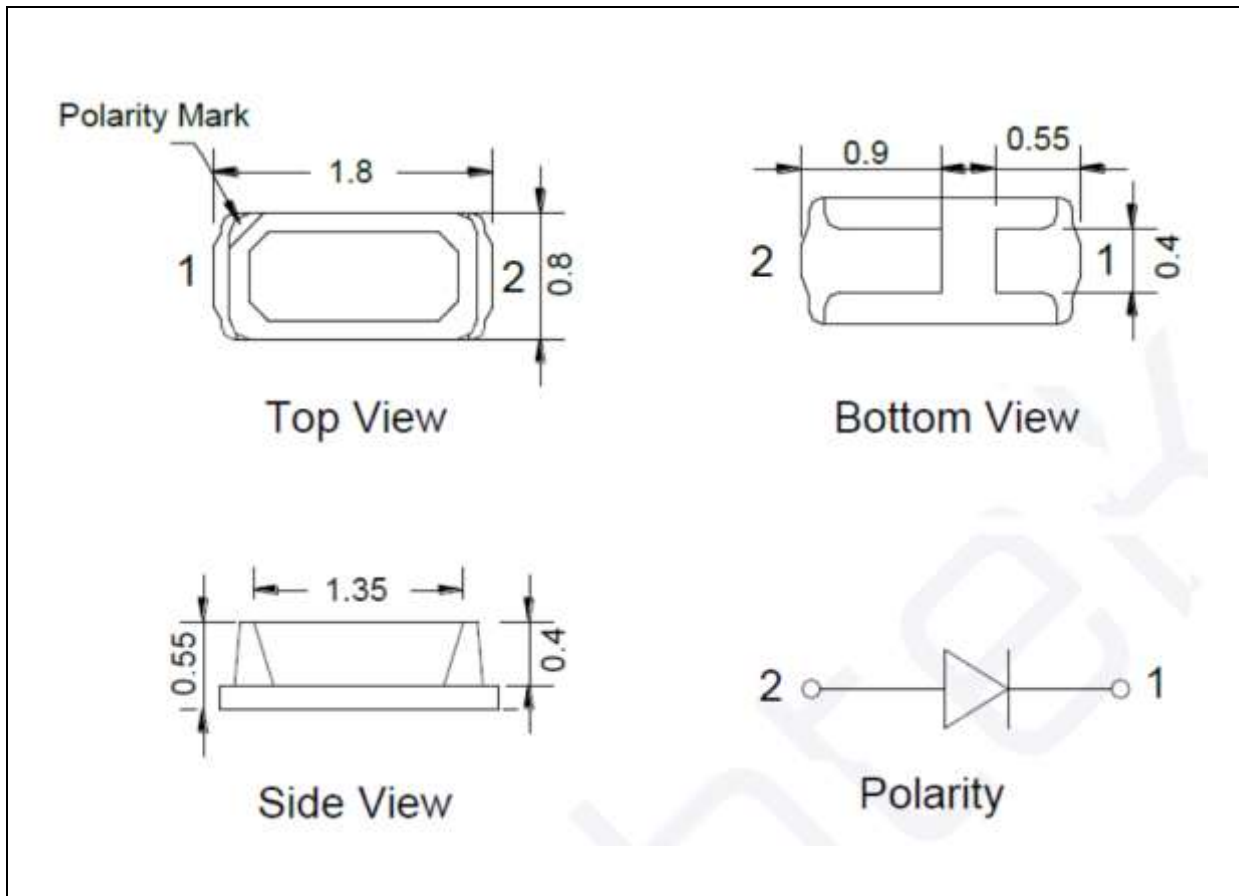

1. All dimensions are in millimetre (mm).
2. Tolerance  $\pm 0.13\text{mm}$ , unless otherwise noted.

Recommended Soldering Pad Dimension:

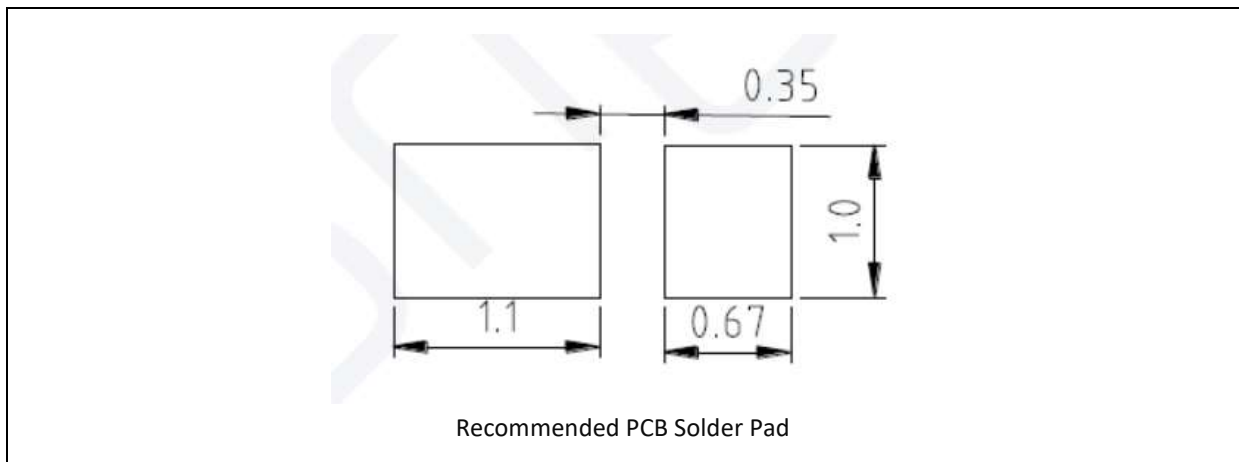

1. Dimensions are in millimetre (mm).
2. Tolerance  $\pm 0.12\text{mm}$  with angle tolerance  $\pm 0.5^\circ$ .

**BINNING GROUPS:**



---

 Forward Voltage Classifications ( $I_F = 5\text{mA}$ ):

Code	Min.	Max.	Unit
H	2.4	2.6	V
J	2.6	2.8	
K	2.8	3.0	
L	3.0	3.2	

 Luminous Intensity Classifications ( $I_F = 5\text{mA}$ ):

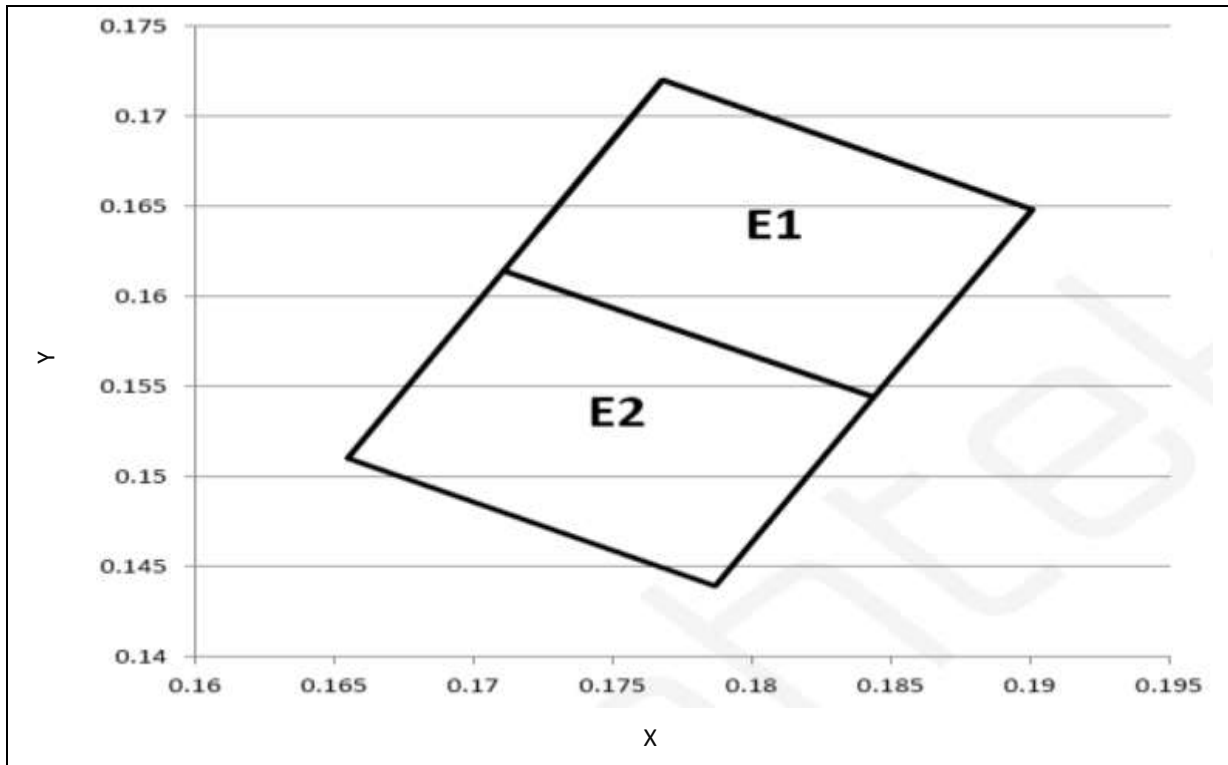
Code	Min.	Max.	Unit
12	100	125	mcd
13	125	160	
14	160	200	
15	200	250	
16	250	320	

**CIE CHROMATICITY DIAGRAM:**

 Chromaticity Coordinates Classifications ( $I_F = 5\text{mA}$ ):

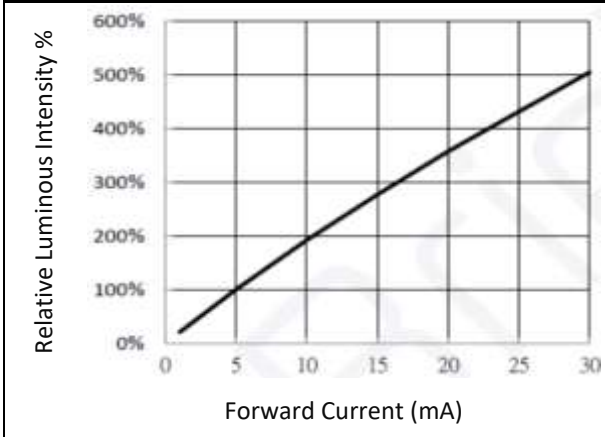
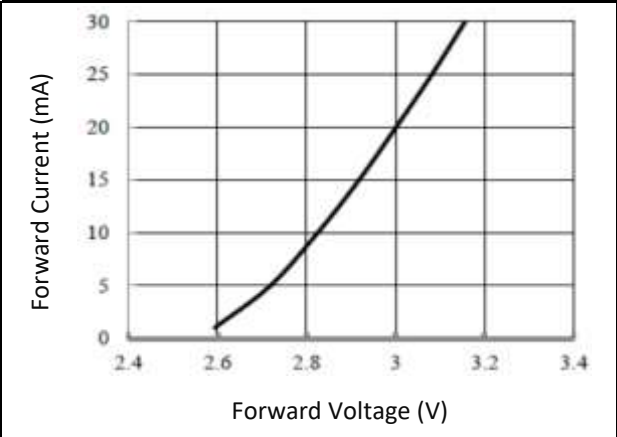
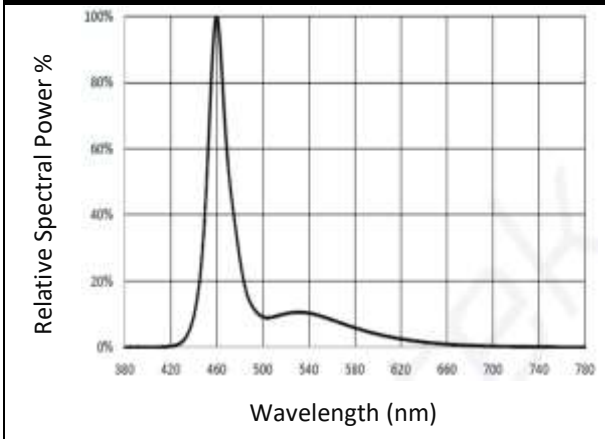
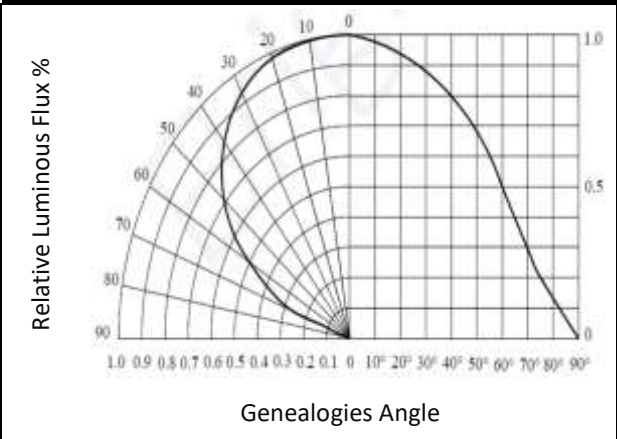
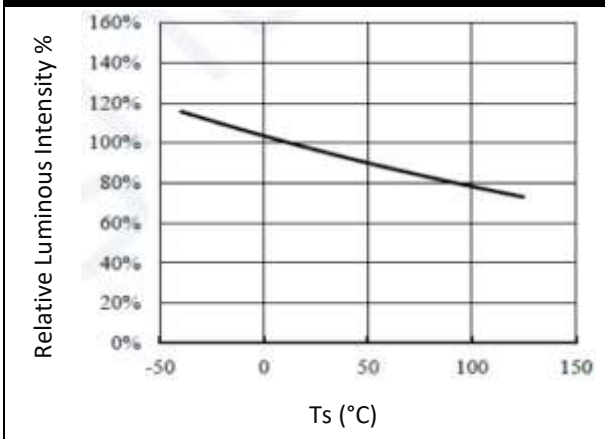
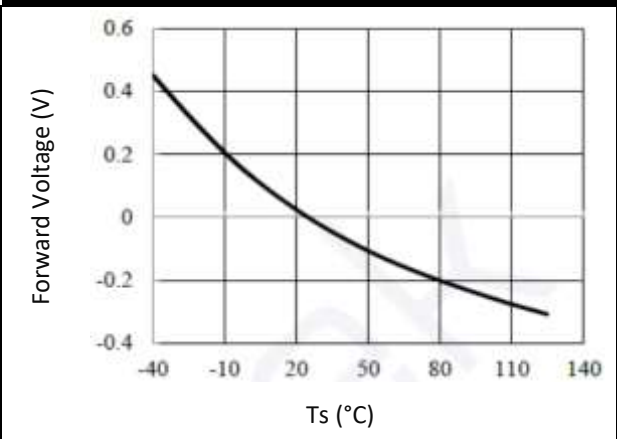
	1		2		3		4	
	X	Y	X	Y	X	Y	X	Y
E1	0.1768	0.1720	0.1901	0.1648	0.1844	0.1544	0.1711	0.1614
E2	0.1844	0.1544	0.1711	0.1614	0.1655	0.1510	0.1787	0.1439

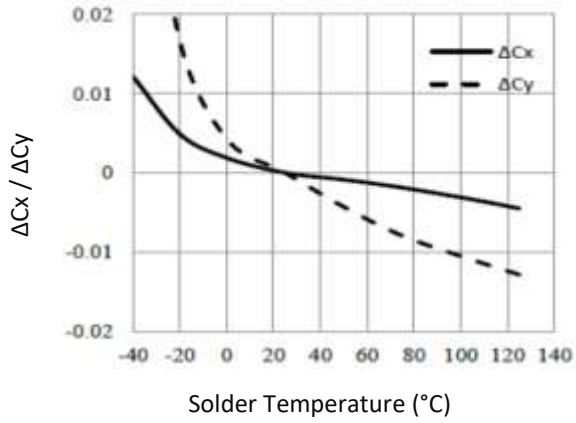
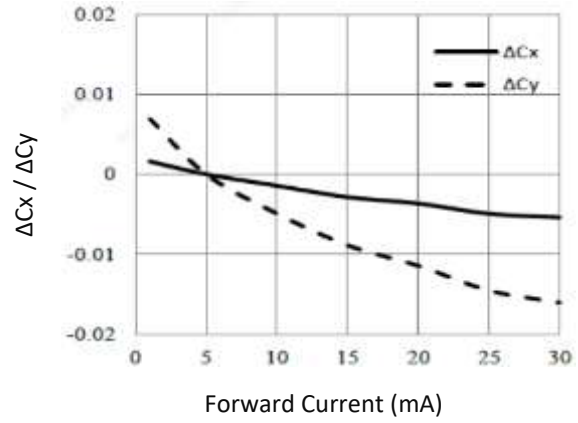
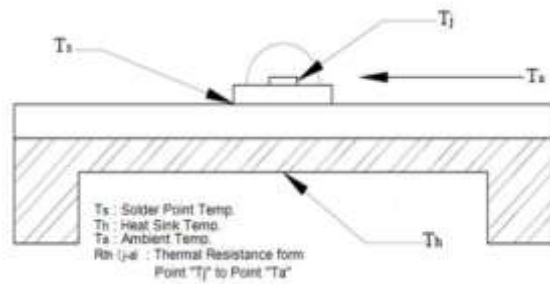
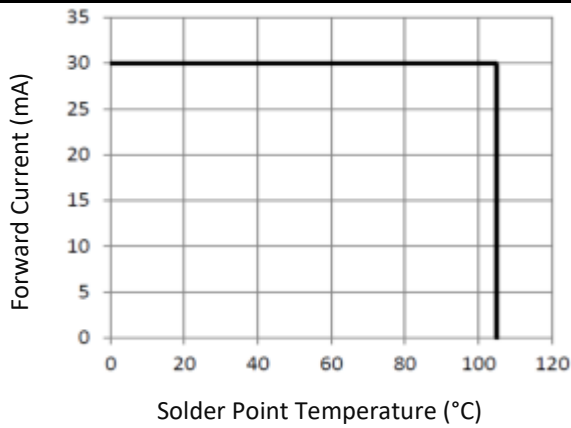
**ELECTRO-OPTICAL CHARACTERISTICS:**
**Relative Luminous Intensity v.s. Forward Current**

**Forward Current v.s. Forward Voltage**

**Relative Spectral Power v.s. Wavelength**

**Directive Radiation**

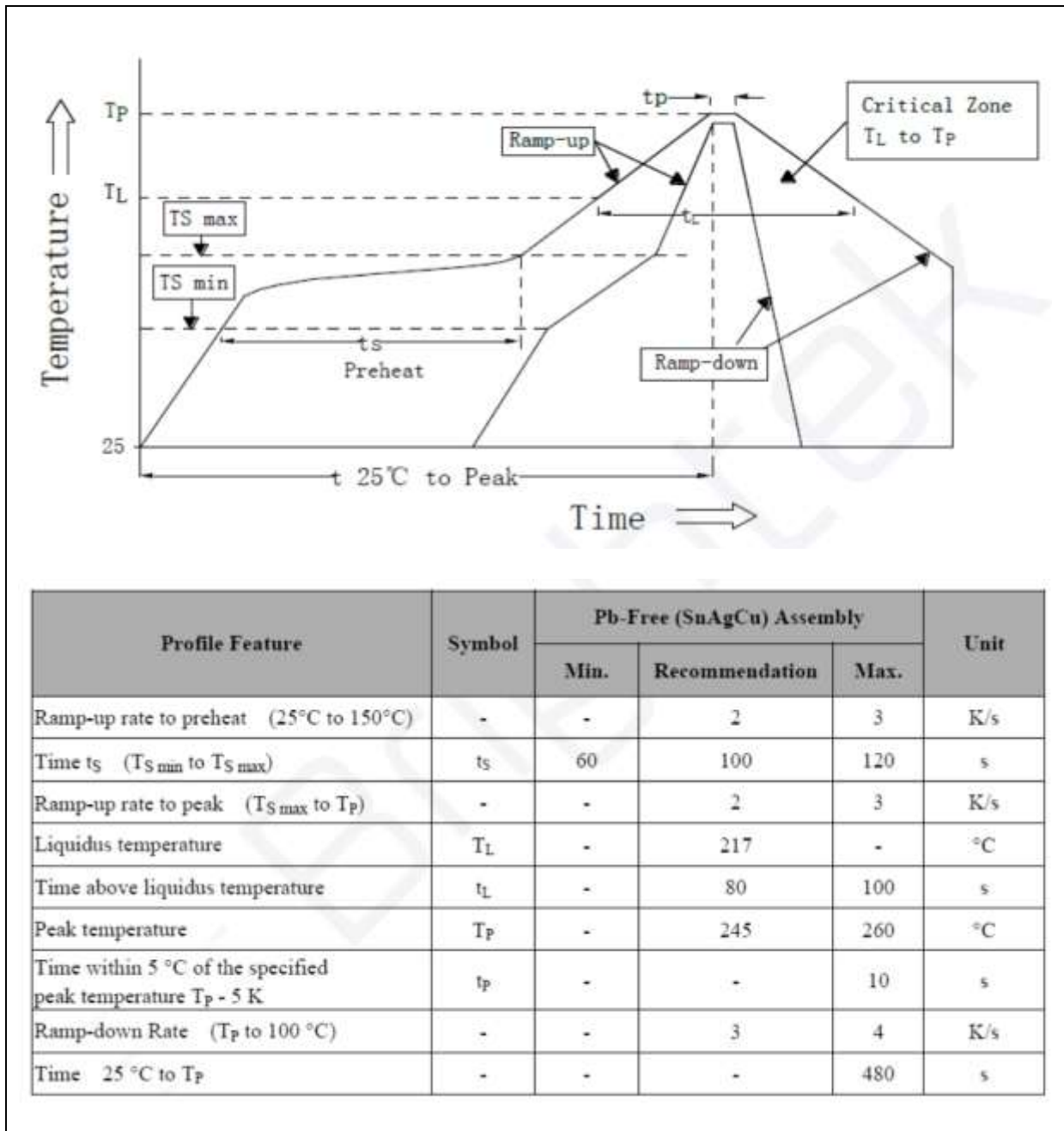
**Relative Luminous Intensity v.s. Solder Temp.**

**Forward Voltage v.s. Solder Temperature**

**Chromaticity Coordinate Shift v.s. Solder Temp.**

**Chromaticity Coordinate Shift v.s. Current**

**Forward Current Derating Curve**

## RECOMMENDED SOLDERING PROFILE:

Reflow Lead-free Solder:



Note:

1. Maximum reflow soldering: 3 times.
2. The recommended reflow temperature is 240°C. The maximum soldering temperature should be limited to 260°C.
3. Before, during, and after soldering, should not apply stress on the components and PCB board.



## PACKING SPECIFICATION:

Reel Dimension:

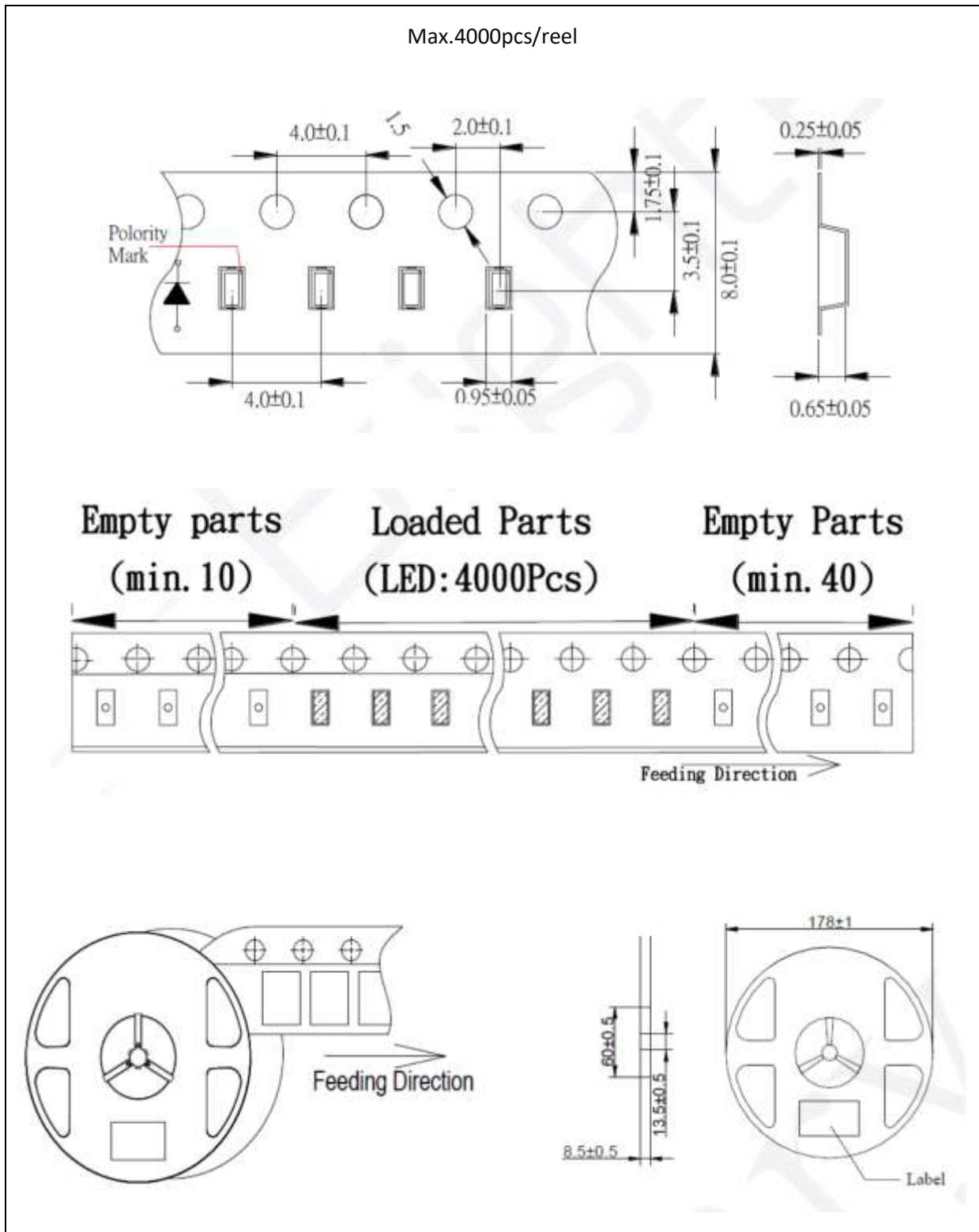

## PRECAUTIONS OF USE:

---

### Storage:

It is recommended to store the products in the following conditions:

- Humidity: 60% R.H. Max.
- Temperature: 5°C~30°C (41°F ~86°F).

Shelf life in sealed bag: 12 months at 5°C~30°C and <60% R.H.

Once the package is opened, the products should be used within a week. Otherwise, they should be kept in a damp-proof box with desiccating agent <10% R.H. and apply baking before use.

### Baking:

It is recommended to bake the LED before soldering if the pack has been unsealed for longer than 24hrs. The suggested baking conditions are as followings:

- 60±3°C x 6hrs and <5%RH, taped / reel package.

It's normal to see slight color fading of carrier (light yellow) after baking in process.

### Testing Circuit:



Must apply resistor(s) for protection (over current proof).

### Cleaning:

Use alcohol-based cleaning solvents such as isopropyl alcohol to clean the LED carrier / package. Avoid putting any stress force directly on to the LED lens.

### ESD (Electrostatic Discharge):

Static Electricity or power surge will damage the LED. Use of a conductive wrist band or anti-electrosatic glove is recommended when handling the LED all time. All devices, equipment, machinery, work tables, and storage racks must be properly grounded.

In the events of manual working in process, make sure the devices are well protected from ESD at any time.

**REVISION RECORD:**

---

Version	Date	Summary of Revision
A1.0	23/04/2020	Datasheet set-up.
A1.1	22/04/2022	New datasheet format.