



BRIGHTTEK
BRIGHTTEK (EUROPE) LIMITED

Brighten Up The World With LED!



ISO/TS 16949:2009



BS EN ISO 14001:2004



QC 080000 IECQ HSPM

PRODUCT DATASHEET



- ▶ Superflux
- ▶ 3mm Round 4.4t
- ▶ Sky White (Ice Blue)

NOW48P19S



Release Date: 26 June 2022 Version: A1.1

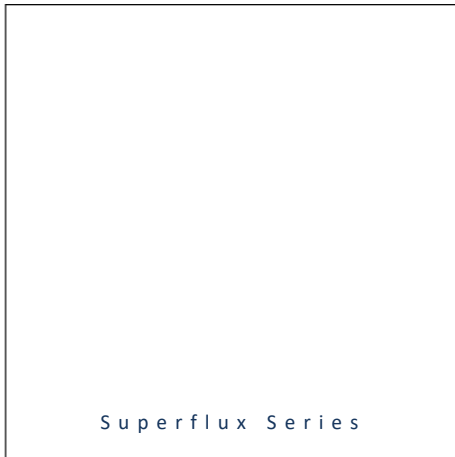

Superflux Series

RoHS
Compliant



FEATURES:

- **Package:** Superflux THT Top View LED
- **Forward Current:** 20mA
- **Forward Voltage (typ.):** 3.5V
- **Luminous Intensity (typ.):** 4000mcd@20mA
- **Colour:** Sky White (Ice Blue)
- **Chromaticity Coordinates (typ.):** X=0.2800; Y=0.2800
- **Viewing angle:** 52°
- **Materials:**
 - Die: InGaN
 - Resin: Epoxy (Water Clear)
 - L/T Finish: Ag plated
- **Operating Temperature:** -20~+80°C
- **Storage Temperature:** -30~+100°C
- **Grouping parameters:**
 - Forward voltage
 - Luminous intensity
 - CIE Chromaticity
- **Soldering methods:** Iron; Wave Soldering
- **Preconditioning:** acc. to JEDEC Level 3
- **Packing:** Max.60pcs/tube; 6300pcs/carton

APPLICATIONS:

- Decorative Lighting
- General Lighting
- Indicator
- Commercial Lighting

CHARACTERISTICS:

Absolute Maximum Characteristics (Ta=25°C)

Parameter	Symbol	Ratings	Unit
Forward Current	I _F	30	mA
Peak Forward Current (Duty 1/10; width 10KHz)	I _{FP}	100	mA
Reverse Current @5V	I _R	50	μA
Power Dissipation	P _D	120	mW
Electrostatic Discharge	ESD	500	V
Operating Temperature	T _{OPR}	-20~+80	°C
Storage Temperature	T _{STG}	-30~+100	°C

Electrical & Optical Characteristics (Ta=25°C)

Parameter	Symbol	Values			Unit	Test Condition
		Min.	Typ.	Max.		
Forward Voltage	V _F	---	3.5	4.0	V	I _F =20mA
Luminous Intensity	I _v	2200	4000	---	lm	I _F =20mA
Chromaticity Coordinates	X	---	0.2800	---	---	I _F =20mA
	Y	---	0.2800	---		
Colour Temperature	CCT	---	10000	---	K	I _F =20mA
Viewing Angle	2θ _{1/2}	---	52	---	deg	I _F =20mA

1. Luminous intensity (I_v) ±15%, Forward Voltage (V_F) ±0.1V, Viewing angle(2θ_{1/2}) ±5%

OUTLINE DIMENSION:

Package Dimension:

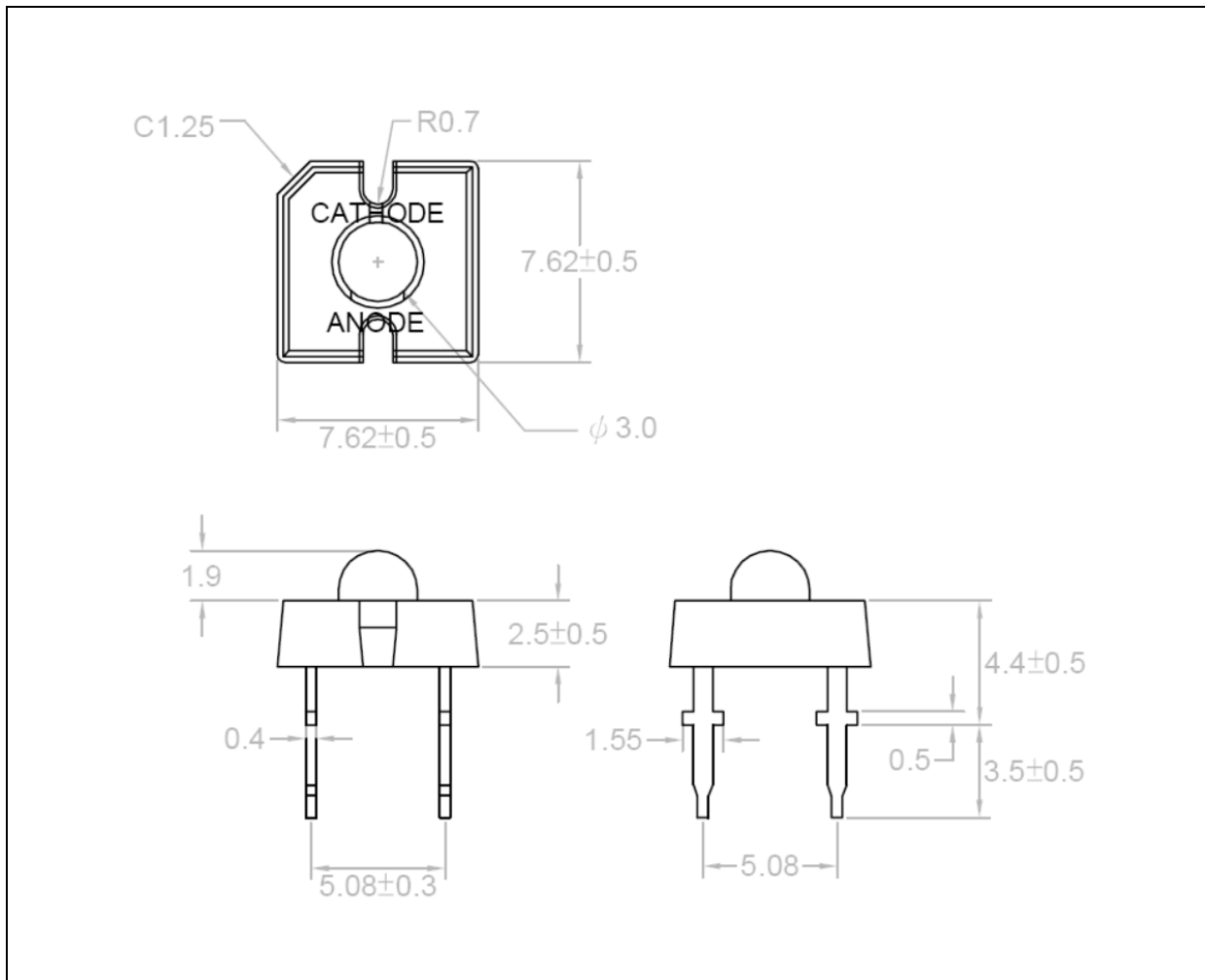

1. All dimensions are in millimetre (mm).
2. Tolerance ± 0.25 mm, unless otherwise noted.

BINNING GROUPS:

 Forward Voltage Classifications ($I_F = 20\text{mA}$):

Code	Min.	Max.	Unit
□	3.0	4.0	V

 Luminous Intensity Classifications ($I_F = 20\text{mA}$):

Code	Min.	Max.	Unit
A25	2200	2700	mcd
A26	2700	3400	
A27	3400	4000	
A28	4000	5000	
A29	5000	6200	
A30	6200	7700	
A31	7700	9500	



CIE CHROMATICITY DIAGRAM:

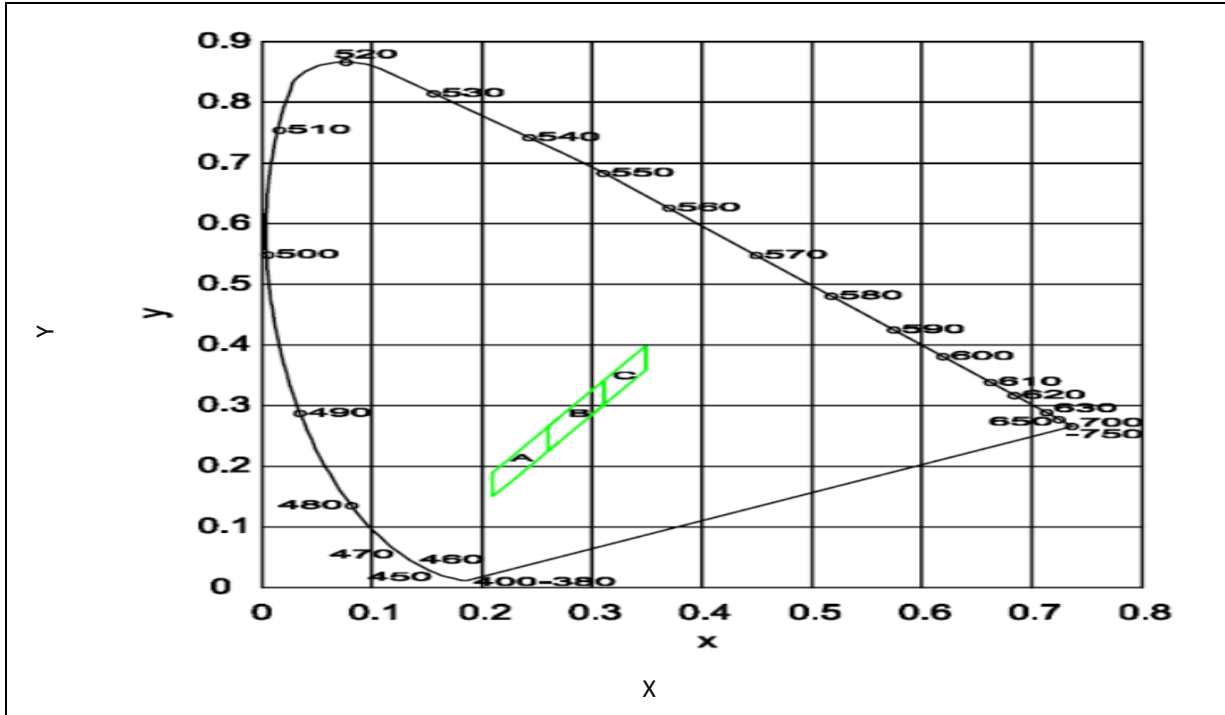

Chromaticity Coordinates Classifications ($I_F = 20\text{mA}$):

	1		2		3		4	
	X	Y	X	Y	X	Y	X	Y
A1	0.2100	0.1900	0.2100	0.1500	0.2200	0.1650	0.2200	0.2050
A2	0.2200	0.2050	0.2200	0.1650	0.2300	0.1800	0.2300	0.2200
A3	0.2300	0.2200	0.2300	0.1800	0.2400	0.1950	0.2400	0.2350
A4	0.2400	0.2350	0.2400	0.1950	0.2500	0.2100	0.2500	0.2500
A5	0.2500	0.2500	0.2500	0.2100	0.2600	0.2250	0.2600	0.2650
B1	0.2600	0.2650	0.2600	0.2250	0.2700	0.2400	0.2700	0.2800
B2	0.2700	0.2800	0.2700	0.2400	0.2800	0.2550	0.2800	0.2950
B3	0.2800	0.2950	0.2800	0.2550	0.2900	0.2700	0.2900	0.3100
B4	0.2900	0.3100	0.2900	0.2700	0.3000	0.2850	0.3000	0.3250
B5	0.3000	0.3250	0.3000	0.2850	0.3100	0.3000	0.3100	0.3400
C1	0.3100	0.3400	0.3100	0.3000	0.3200	0.3150	0.3200	0.3550
C2	0.3200	0.3550	0.3200	0.3150	0.3300	0.3300	0.3300	0.3700
C3	0.3300	0.3700	0.3300	0.3300	0.3400	0.3450	0.3400	0.3850
C4	0.3400	0.3850	0.3400	0.3450	0.3500	0.3600	0.3500	0.4000

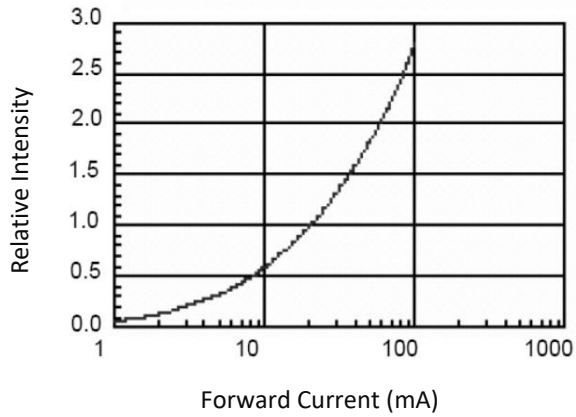
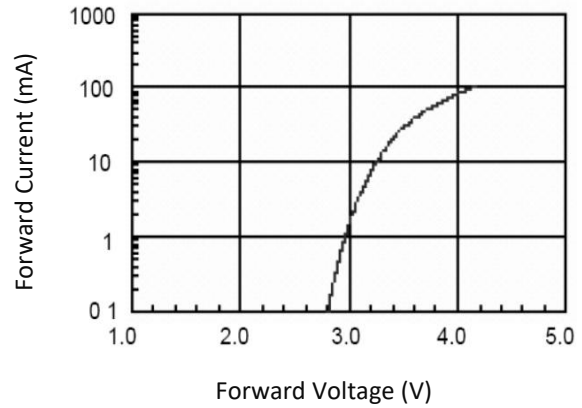
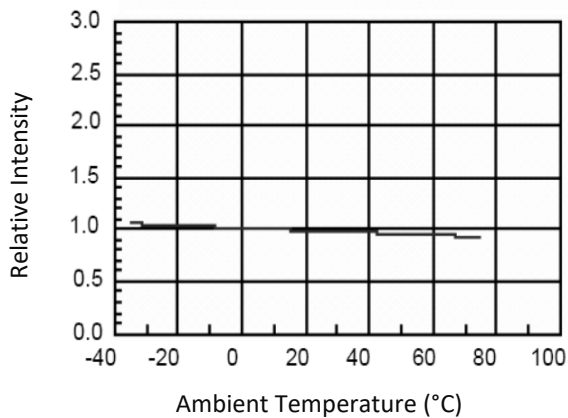
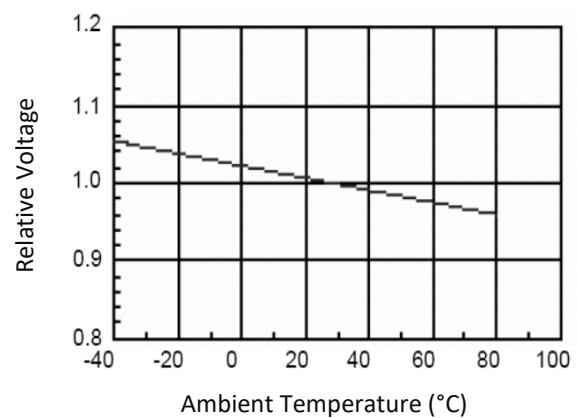
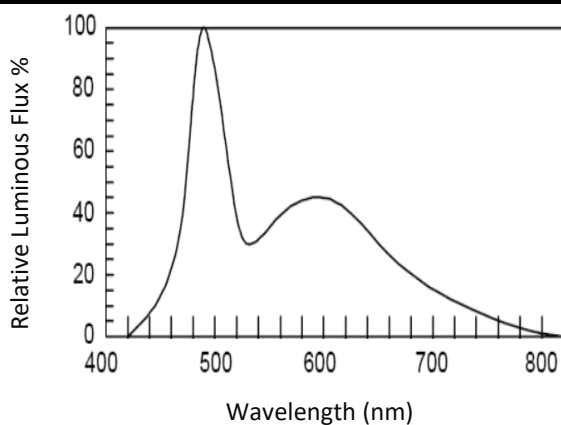
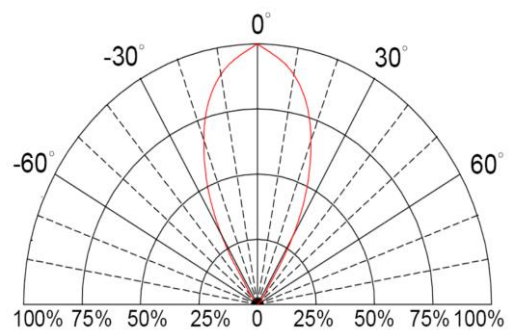
ELECTRO-OPTICAL CHARACTERISTICS:
Relative Intensity v.s. Forward Current

Forward Current v.s. Forward Voltage

Relative Luminous Intensity v.s. Ambient Temp.

Relative Voltage v.s. Ambient Temp.

Luminous Spectrum

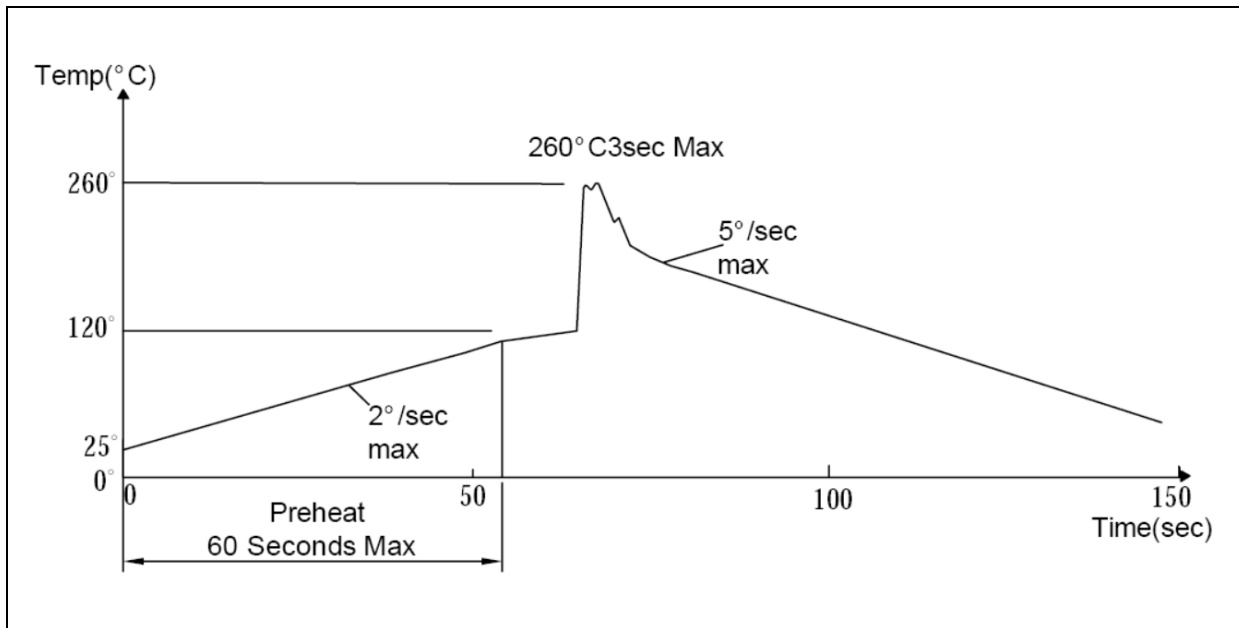
Directive Radiation

RECOMMENDED SOLDERING PROFILE:

Iron:

- Soldering Iron: 30W Max.
- Temperature 350°C Max.
- Soldering Time: 3 Seconds Max. 1 Time Only.
- Distance: 2mm min. from solder joint to body.

Wave Soldering:



Note:

1. Maximum reflow soldering: 1 time.
2. Before, during, and after soldering, should not apply stress on the components and PCB board.

PACKING SPECIFICATION:

Reel Dimension:

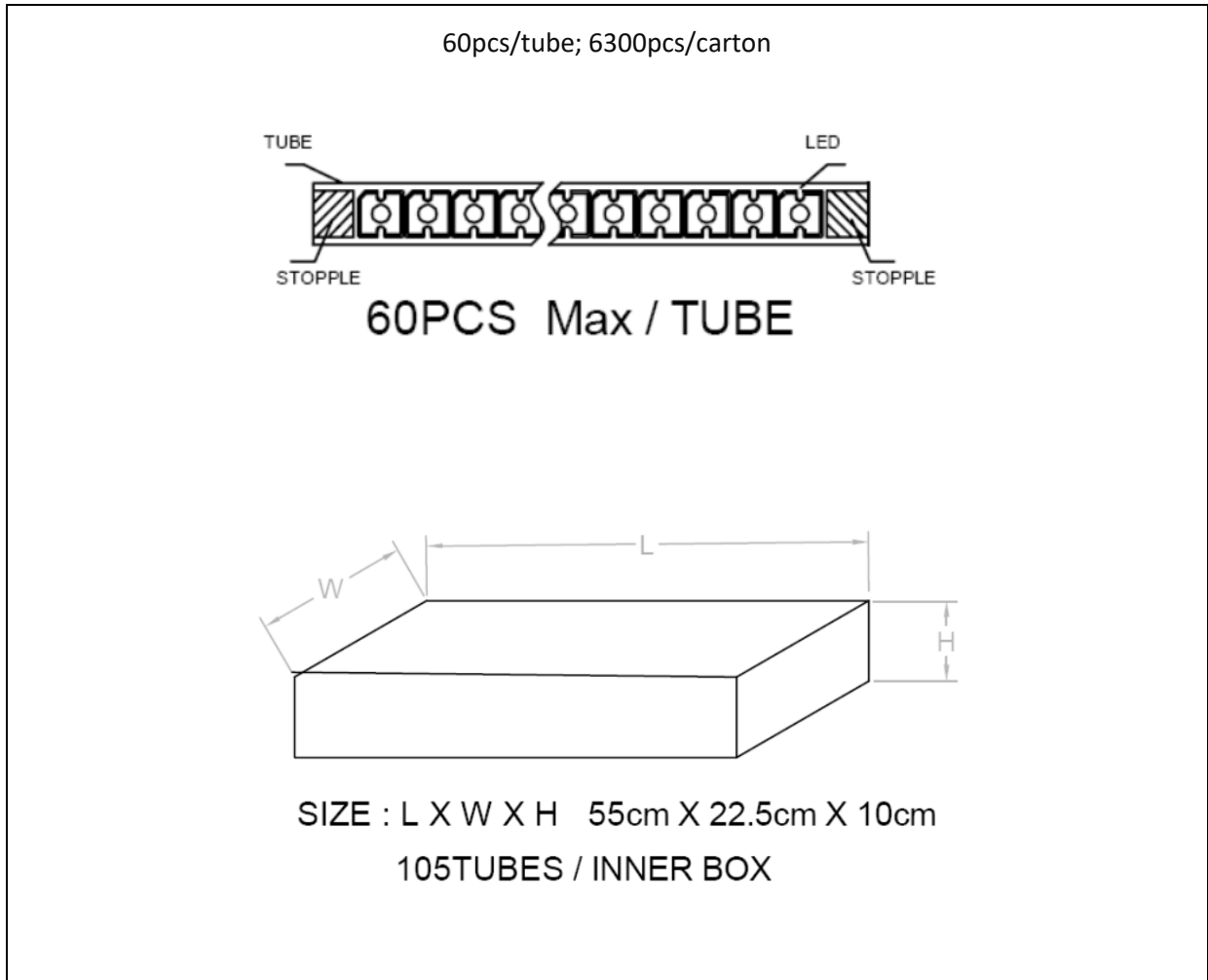

PRECAUTIONS OF USE:

Storage:

It is recommended to store the products in the following conditions:

- Humidity: 60% R.H. Max.
- Temperature: 5°C~30°C (41°F ~86°F).

Shelf life in sealed bag: 12 months at 5°C~30°C and <60% R.H.

Once the package is opened, the products should be used within a week. Otherwise, they should be kept in a damp-proof box with desiccating agent <10% R.H. and apply baking before use.

Baking:

It is recommended to bake the LED before soldering if the pack has been unsealed for longer than 24hrs. The suggested baking conditions are as followings:

- 60±3°C x 12hrs and <5%RH, taped / reel package.

It's normal to see slight color fading of carrier (light yellow) after baking in process.

Testing Circuit:

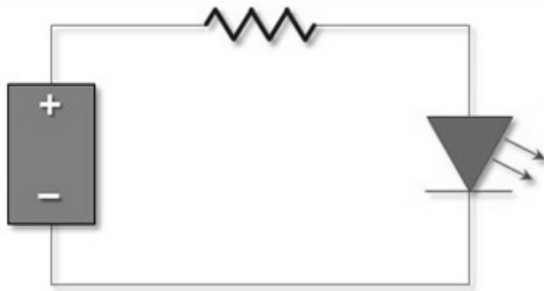

Must apply resistor(s) for protection (over current proof).

Cleaning:

Use alcohol-based cleaning solvents such as isopropyl alcohol to clean the LED carrier / package. Avoid putting any stress force directly on to the LED lens.

ESD (Electrostatic Discharge):

Static Electricity or power surge will damage the LED. Use of a conductive wrist band or anti-electrostatic glove is recommended when handling the LED all time. All devices, equipment, machinery, work tables, and storage racks must be properly grounded.

In the events of manual working in process, make sure the devices are well protected from ESD at any time.

REVISION RECORD:

Version	Date	Summary of Revision
A1.0	18/01/2019	Datasheet set-up.
A1.1	26/06/2022	Add -S ending.