



**BRIGHTTEK**  
BRIGHTTEK (EUROPE) LIMITED

*Brighten up The World With LED!*



ISO/TS 16949:2009



BSI  
BS EN ISO 14001:2004



QC 800000 IECQ HSP01

## PRODUCT DATASHEET



- ▶ PLCC2 SMD
- ▶ 3020 1.3t Series
- ▶ Sky White (Ice Blue)

Release Date: 29 May 2022 Version: A1.1

# NOW40S85Z-10MA



### 3020 1.3t Series

**RoHS**  
Compliant



#### FEATURES:

- **Package:** Top View PLCC2 White SMD Package
- **Forward Current:** 10mA
- **Forward Voltage (typ.):** 3.0V
- **Luminous Intensity (typ.):** 700mcd@10mA
- **Colour:** Sky White (Ice Blue)
- **Colour Temperature (CCT):** X=0.1800; Y=0.2200
- **Viewing angle:** 120°
- **Materials:**
  - Die: InGaN
  - Resin: Silicon (Yellow Diffused)
  - L/T Finish: Ag plated
- **Operating Temperature:** -40~+85°C
- **Storage Temperature:** -40~+100°C
- **ESD (HBM):** 6kV
- **Grouping parameters:**
  - Forward Voltage
  - Luminous Intensity
  - CIE Chromaticity
- **Soldering methods:** Reflow Soldering
- **Preconditioning:** MSL 2a according to J-STD020
- **Packing:** 8mm tape with max.3000/reel,  $\phi$ 180mm (7")

#### APPLICATIONS:

- Portable Lighting
- Commercial Lighting
- Indoor Lighting
- Backlight for LCD
- General Lighting

## CHARACTERISTICS:

### Absolute Maximum Characteristics (Ta=25°C)

Parameter	Symbol	Ratings	Unit
DC Forward Current	I <sub>F</sub>	30	mA
Pulse Forward Current @Duty 1/10, 0.1ms	I <sub>PF</sub>	100	mA
Reverse Voltage	V <sub>R</sub>	5	V
Reverse Current @10V	I <sub>R</sub>	10	μA
Junction Temperature	T <sub>j</sub>	110	°C
Electrostatic Discharge (HBM)	ESD	6000	V
Operating Temperature	T <sub>OPR</sub>	-40~+85	°C
Storage Temperature	T <sub>STG</sub>	-40~+100	°C
Soldering Temperature	T <sub>SOL</sub>	260	°C

### Electrical & Optical Characteristics (Ta=25°C)

Parameter	Symbol	Values			Unit	Test Condition
		Min.	Typ.	Max.		
Forward Voltage	V <sub>F</sub>	2.6	---	3.4	V	I <sub>F</sub> =10mA
Luminous Intensity	I <sub>v</sub>	500	700	---	mcd	I <sub>F</sub> =10mA
Chromaticity Coordinates	X	---	0.1800	---	---	I <sub>F</sub> =10mA
	Y	---	0.2200	---		
Viewing Angle	2θ <sub>1/2</sub>	---	120	---	deg	I <sub>F</sub> =10mA

1. Luminous Intensity (Φ<sub>v</sub>) ±10%, Forward Voltage (V<sub>F</sub>) ±0.1V, Colour Coordinate: ±0.005, Viewing Angle(2θ<sub>1/2</sub>) ±5%

## OUTLINE DIMENSION:

Package Dimension:

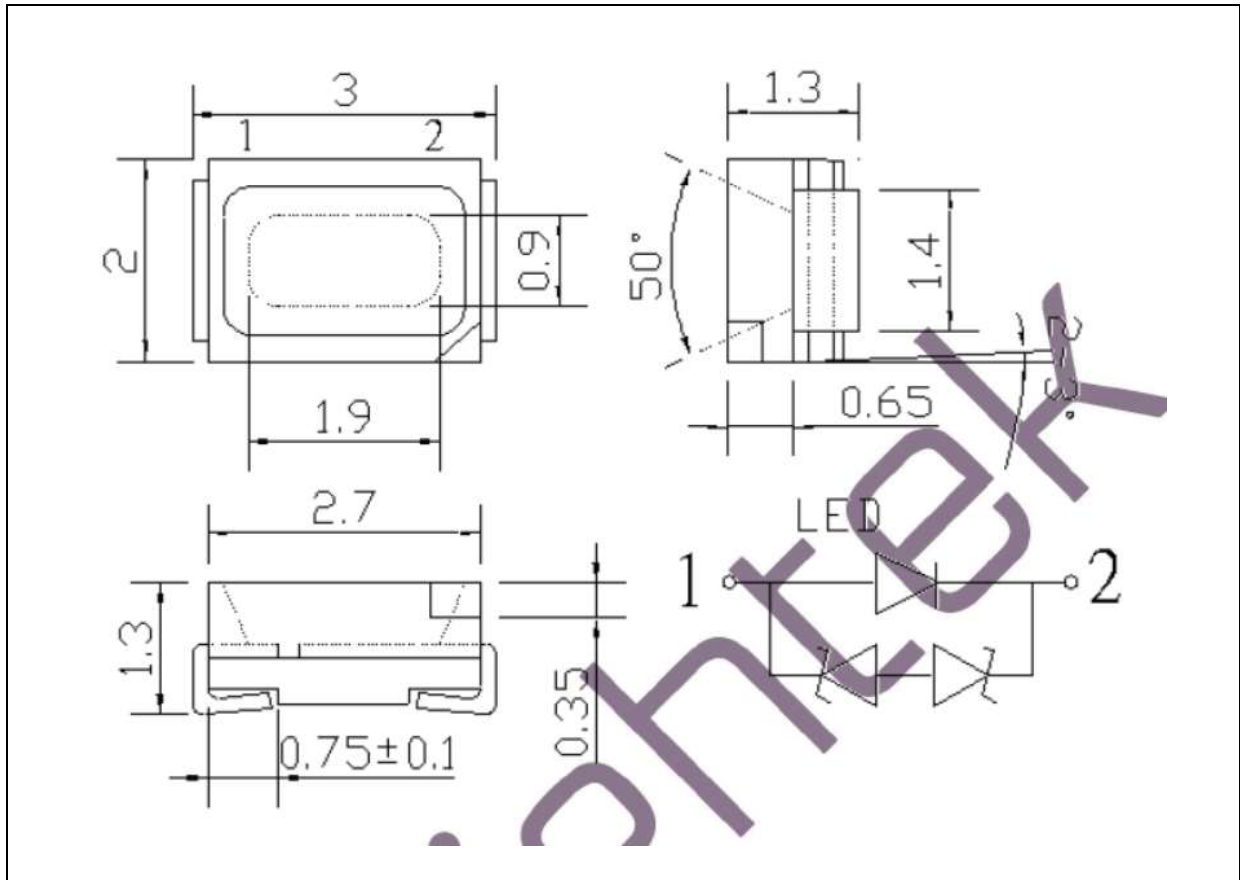

1. All dimensions are in millimetre (mm).
2. Tolerance  $\pm 0.13$ mm, unless otherwise noted.

Recommended Soldering Pad Dimension:

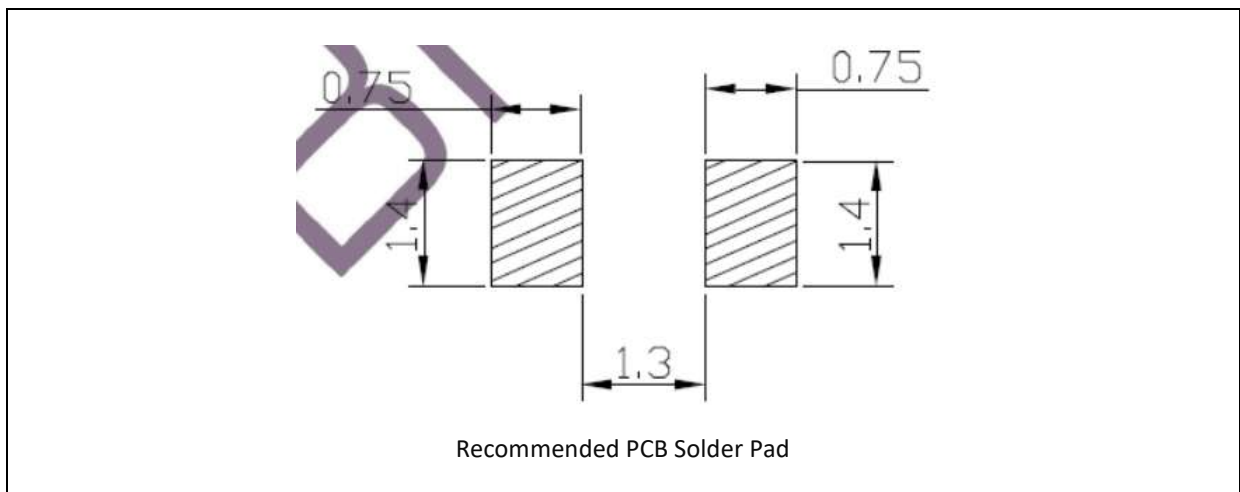

1. Dimensions are in millimetre (mm).
2. Tolerance  $\pm 0.1$ mm with angle tolerance  $\pm 0.5^\circ$ .

**BINNING GROUPS:**



---

 Forward Voltage Classifications ( $I_F = 10\text{mA}$ ):

Code	Min.	Max.	Unit
B1	2.6	2.7	V
B2	2.7	2.8	
C1	2.8	2.9	
C2	2.9	3.0	
D1	3.0	3.1	
D2	3.1	3.2	
E1	3.2	3.3	
E2	3.3	3.4	

 Luminous Intensity Classifications ( $I_F = 10\text{mA}$ ):

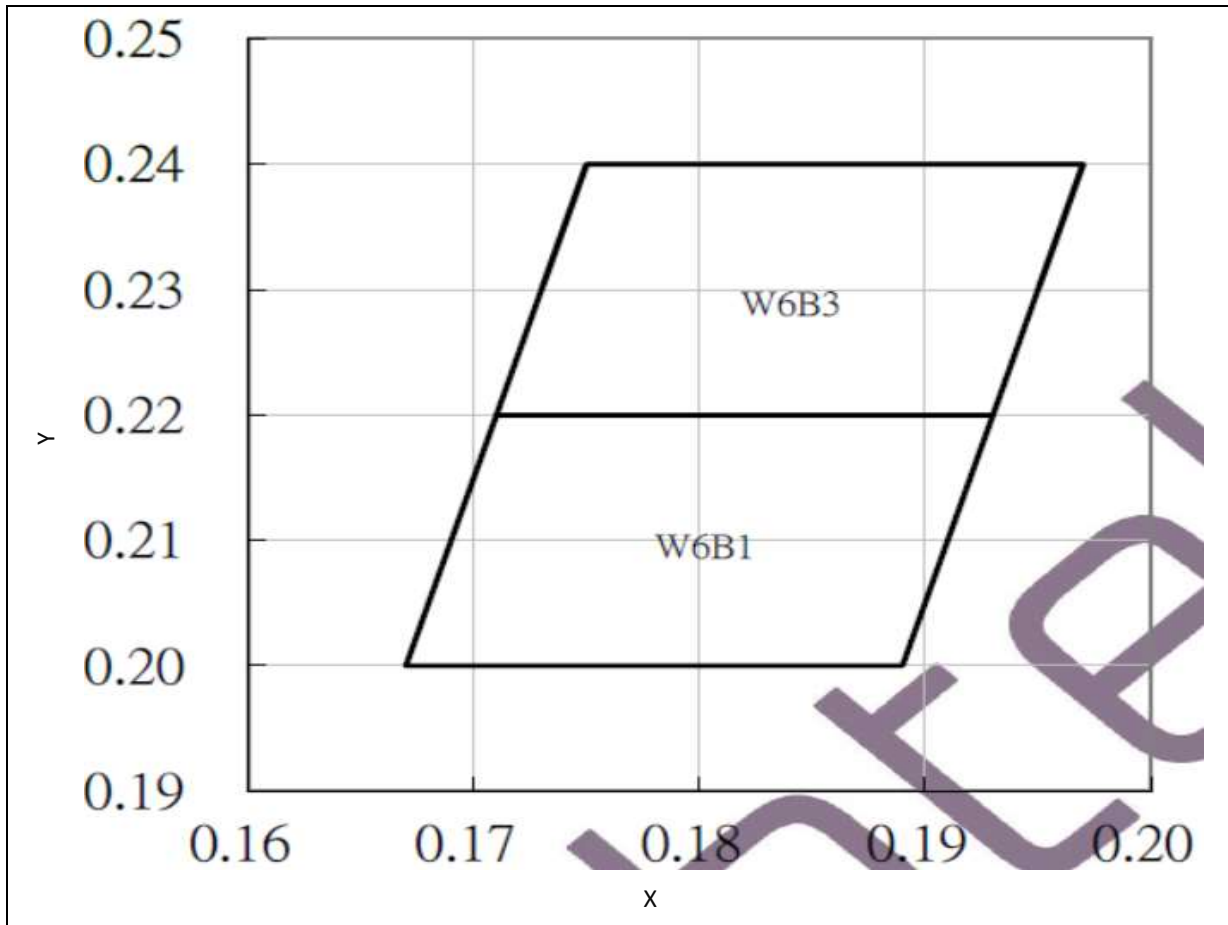
Code	Min.	Max.	Unit
5	500	600	mcd
6	600	700	
7	700	800	

**CIE CHROMATICITY DIAGRAM:**

 Chromaticity Coordinates Classifications ( $I_F = 10\text{mA}$ ):

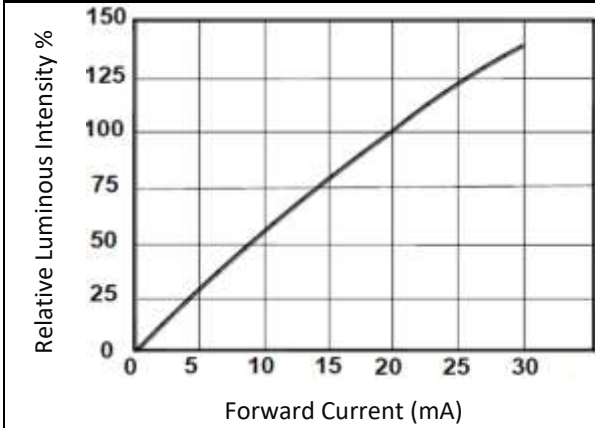
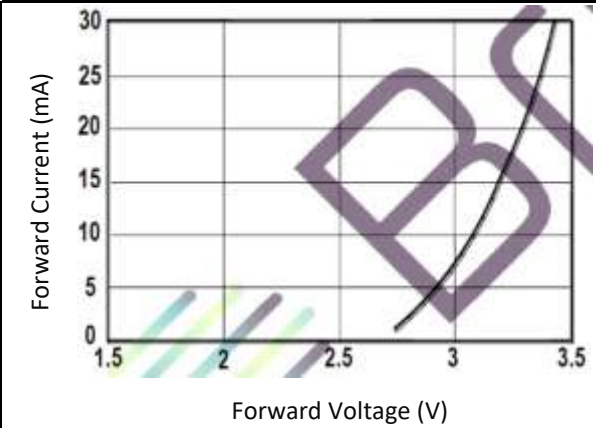
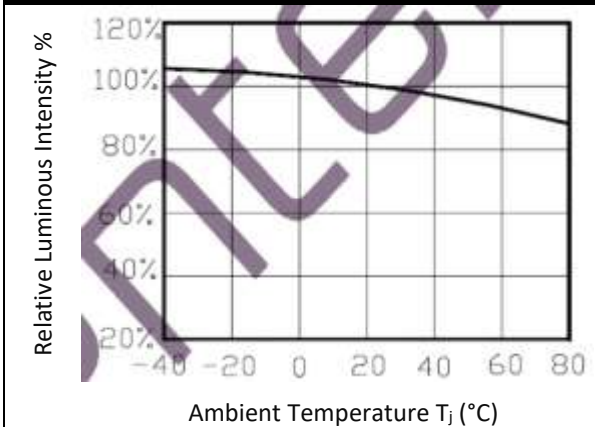
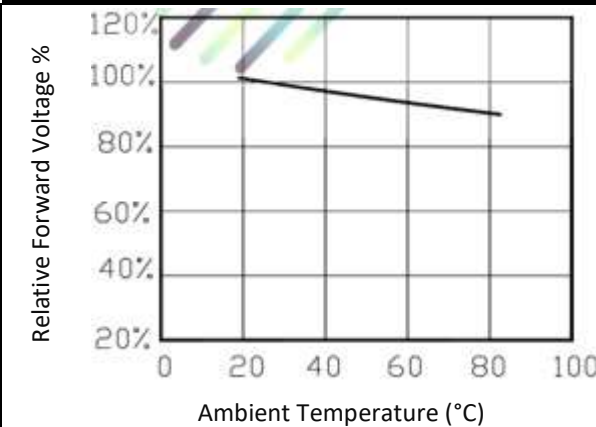
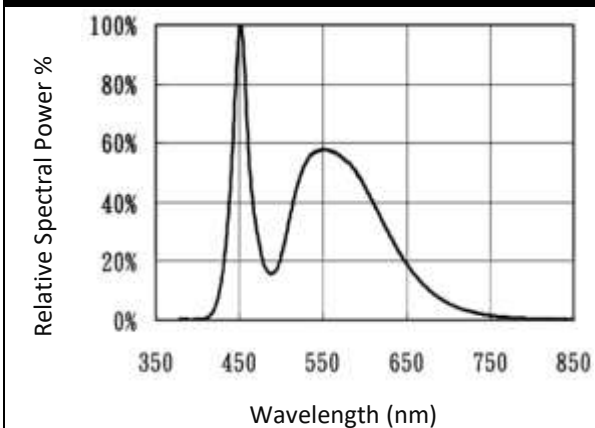
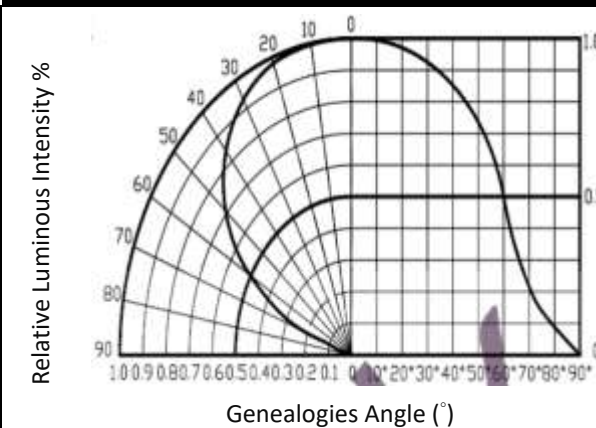
	1		2		3		4	
	X	Y	X	Y	X	Y	X	Y
W6B3	0.1930	0.2200	0.1710	0.2200	0.1750	0.2400	0.1970	0.2400
W6B1	0.1890	0.2000	0.1670	0.2000	0.1710	0.2200	0.1930	0.2200

**ELECTRO-OPTICAL CHARACTERISTICS:**
**Relative Luminous Intensity v.s. Forward Current**

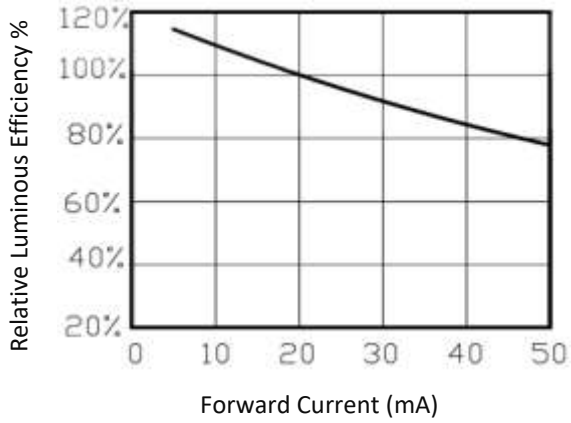
**Forward Current v.s. Forward Voltage**

**Relative Luminous Intensity v.s. Ambient Temp.**

**Relative Forward Voltage v.s. Ambient Temp.**

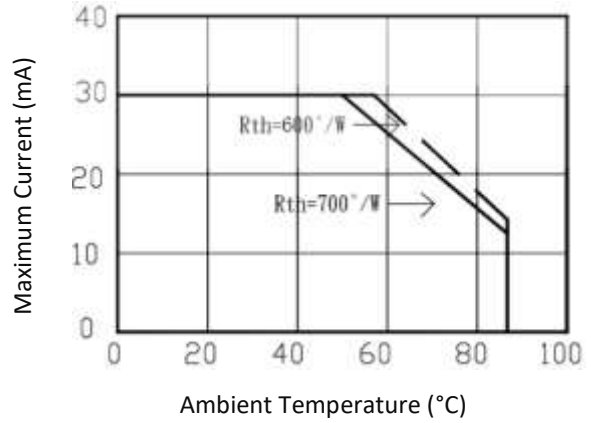
**Relative Spectral Power v.s. Wavelength**

**Directive Radiation**

Relative Emission Efficiency v.s. Forward Current



Forward Current Derating Curve



## RECOMMENDED SOLDERING PROFILE:

IR Reflow Lead-free Solder:

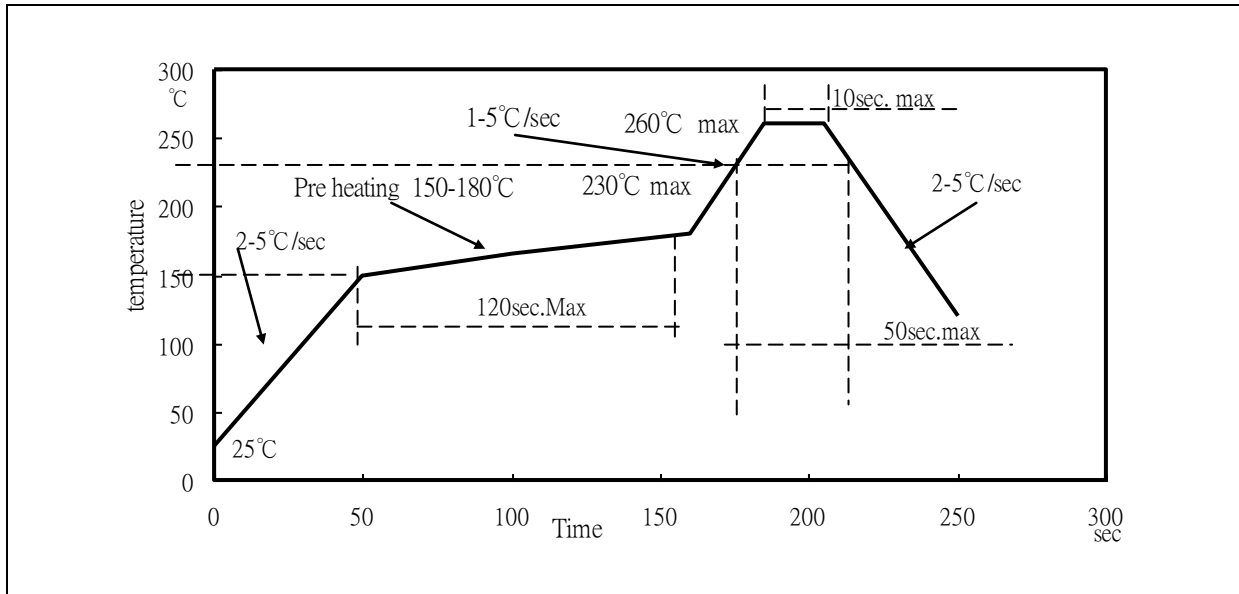

Note:

1. Recommended soldering temperature: 240°C. The maximum soldering temperature should be limited to 260°C.
2. Maximum reflow soldering: 3 times.
3. Before, during, and after soldering, should not apply stress on the components and PCB board.



**PACKING SPECIFICATION:**

Reel Dimension:

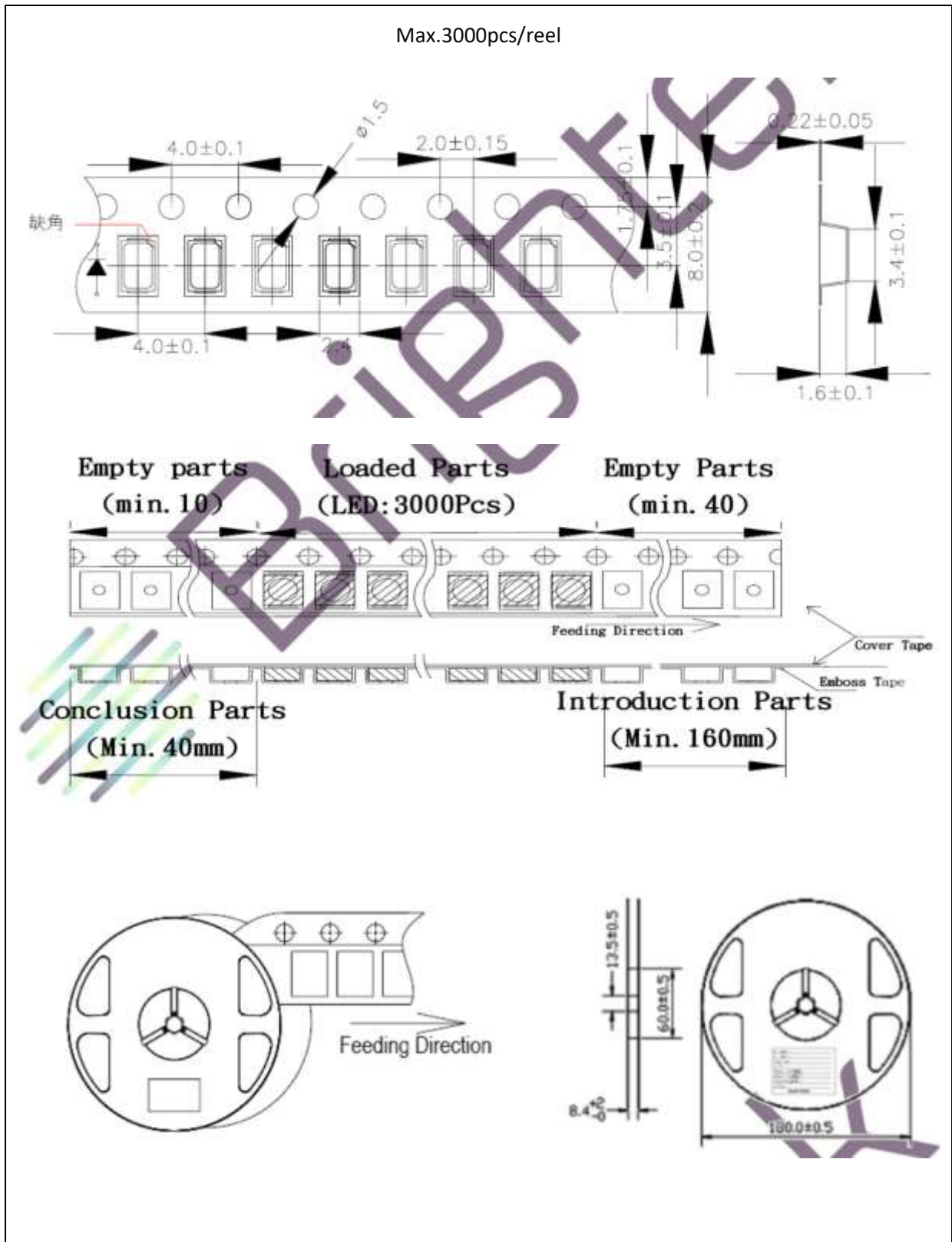

## PRECAUTIONS OF USE:

---

### Storage:

It is recommended to store the products in the following conditions:

- Humidity: 60% R.H. Max.
- Temperature: 5°C~30°C (41°F ~86°F).

Shelf life in sealed bag: 12 months at 5°C~30°C and <60% R.H.

Once the package is opened, the products should be used within a week. Otherwise, they should be kept in a damp-proof box with desiccating agent <10% R.H. and apply baking.

### Baking:

It is recommended to bake the LED before soldering if the pack has been unsealed for longer than 24hrs. The suggested baking conditions are as followings:

- 60±3°C x 24hrs and <5%RH, taped / reel package.

It's normal to see slight color fading of carrier (light yellow) after baking in process.

### Testing Circuit:



Must apply resistor(s) for protection (over current proof).

### Cleaning:

Use alcohol-based cleaning solvents such as isopropyl alcohol to clean the LED carrier / package. Avoid putting any stress force directly on to the LED lens.

### ESD (Electrostatic Discharge):

Static Electricity or power surge will damage the LED. Use of a conductive wrist band or anti-electrosatic glove is recommended when handling the LED all time. All devices, equipment, machinery, work tables, and storage racks must be properly grounded.

In the events of manual working in process, make sure the devices are well protected from ESD at any time.

**REVISION RECORD:**

---

Version	Date	Summary of Revision
A1.0	29/06/2017	Datasheet set-up.
A1.1	29/05/2022	New datasheet format.