



BRIGHTTEK
BRIGHTTEK (EUROPE) LIMITED

Brighten up The World With LED!



ISO/TS 16949:2009



BS EN ISO 14001:2004



QC 080000 IECQ HSPM

PRODUCT DATASHEET



- ▶ EMC 2-PIN SMD
- ▶ 1616 Cube 0.9t
- ▶ Cool White (5000K)

NOW30S41



Release Date: 05 April 2018 Version: A1.1



1616 EMC Series

1616 EMC Series

RoHS Compliant



FEATURES:

- **Package:** Top View EMC Package
- **Forward Current:** 150mA
- **Forward Voltage (typ.):** 6.2V
- **Luminous Flux (typ.):** 130lm@150mA
- **Colour:** Cool White
- **Colour Temperature (CCT):** 5000K
- **Viewing angle:** 170°
- **Materials:**
 - Die: InGaN
 - Resin: Silicon (Yellow Diffused)
 - Package: EMC
- **Operating Temperature:** -40~+85°C
- **Storage Temperature:** -40~+85°C
- **Electrostatics Discharge:** 2000V
- **Grouping parameters:**
 - Forward Voltage
 - Luminous Flux
 - CIE Chromaticity
- **Soldering methods:** Reflow Soldering
- **MSL Level:** MSL3 according to J-STD020
- **Packing:** 8mm tape with Max.5000/reel, ø178mm (7.5")

APPLICATIONS:

- General Lighting
- Portable Lighting
- Commercial Lighting
- Indoor Lighting
- Backlight for LCD

CHARACTERISTICS:

Absolute Maximum Characteristics (Ta=25°C, RH=60%)

| Parameter | Symbol | Ratings | Unit |
|--|-------------------|--------------------|------|
| DC Forward Current | I _F | 200 | mA |
| Pulse Forward Current (Duty 1/10, width≤100μS) | I _{PF} | 300 | mA |
| Power Dissipation | P _D | 1240 | mW |
| Reverse Voltage | V _R | 5 | V |
| Reverse Current @10V | I _R | 10 | μA |
| Junction Temperature | T _j | 115 | °C |
| Electrostatic Discharge | ESD | 2000 | V |
| Thermal Resistance (Junction to Solder Point) | R _{THJS} | 12 | °C/W |
| Operating Temperature | T _{OPR} | -40~+85 | °C |
| Storage Temperature | T _{STG} | -40~+85 | °C |
| Soldering Temperature | T _{SOL} | 230 or 260 for 10S | °C |
| Colour Rendering Index | CRI | 80 | --- |

Electrical & Optical Characteristics (Ta=25°C, RH=60%)

| Parameter | Symbol | Values | | | Unit | Test Condition |
|--------------------------|-------------------|--------|--------|------|------|-----------------------|
| | | Min. | Typ. | Max. | | |
| Forward Voltage | V _F | 5.9 | 6.2 | 6.9 | V | I _F =150mA |
| Luminous Flux | Φ _v | 114 | 130 | 139 | lm | I _F =150mA |
| Chromaticity Coordinates | X | --- | 0.3530 | --- | --- | I _F =150mA |
| | Y | --- | 0.3665 | --- | | |
| Colour Temperature | CCT | 4745 | 5028 | 5311 | K | I _F =150mA |
| Viewing Angle | 2θ _{1/2} | --- | 170 | --- | deg | I _F =150mA |

1. Luminous flux (Φ_v) ±10%, Forward Voltage (V_F) ±0.1V

OUTLINE DIMENSION:

Package Dimension:

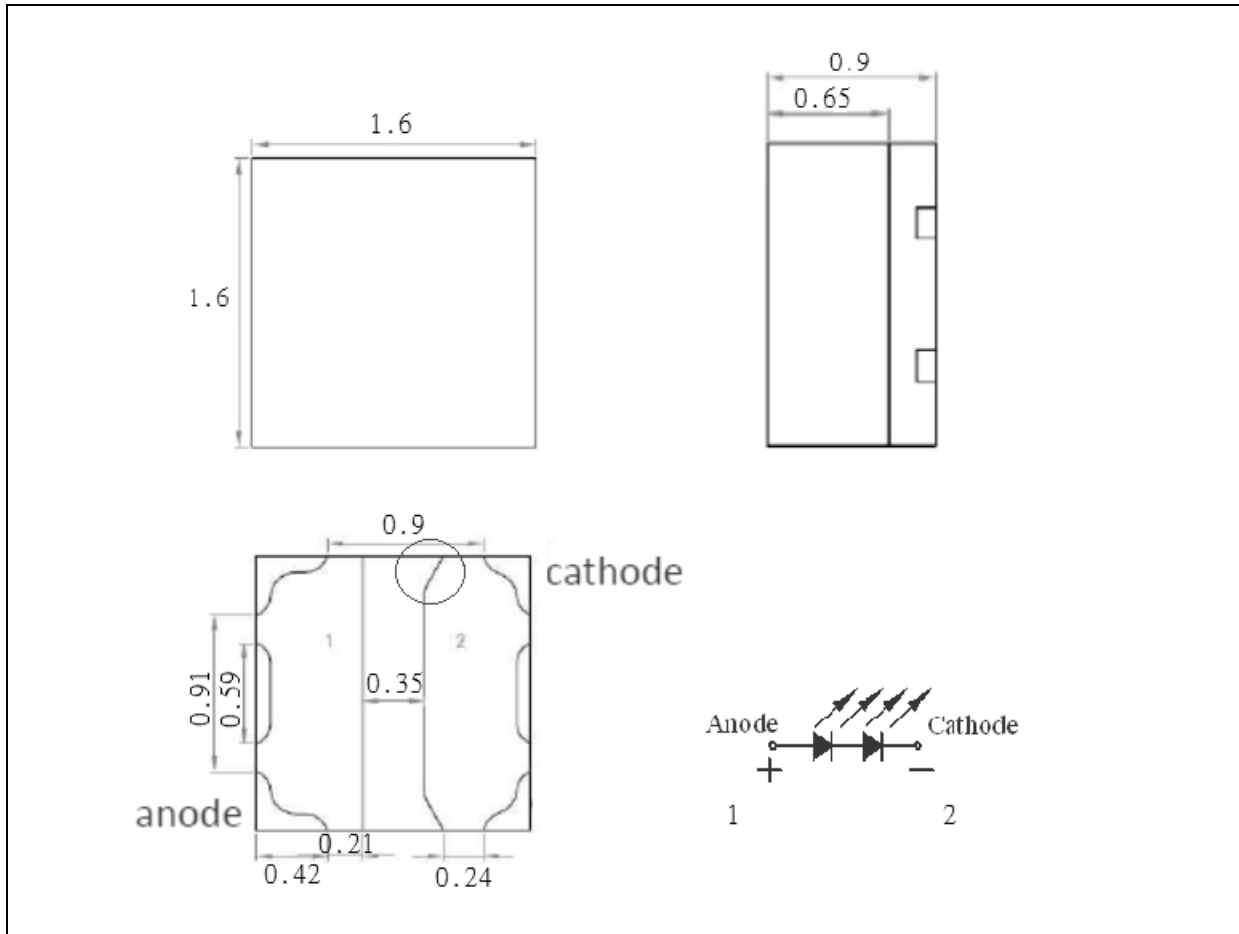

1. All dimensions are in millimetre (mm).
2. Tolerance $\pm 0.2\text{mm}$, unless otherwise noted.

Recommended Soldering Pad Dimension:

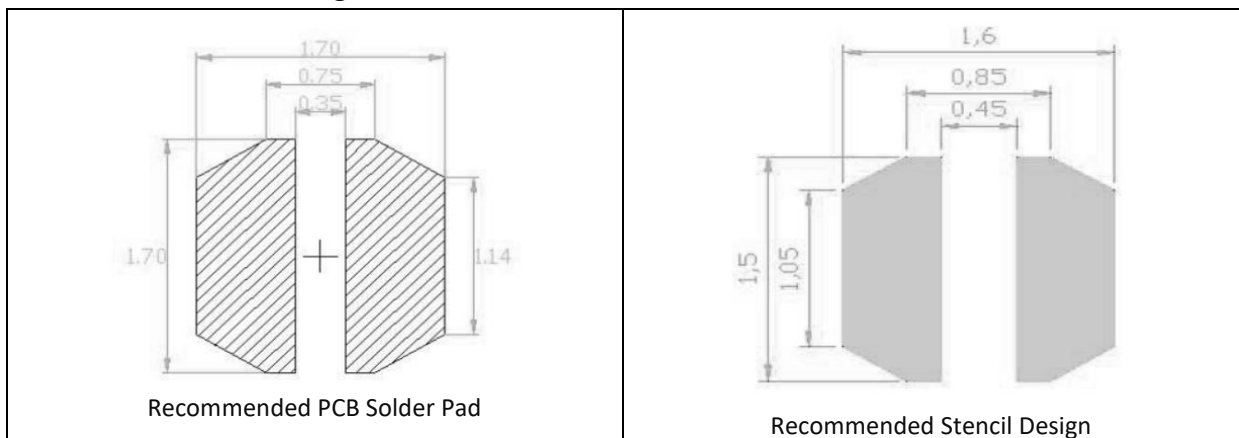

1. Dimensions are in millimetre (mm).
2. Tolerance $\pm 0.1\text{mm}$ with angle tolerance $\pm 0.5^\circ$.

BINNING GROUPS:

 Forward Voltage Classifications ($I_F = 150\text{mA}$):

| Code | Min. | Max. | Unit |
|------|------|------|------|
| B | 5.9 | 6.1 | V |
| C | 6.1 | 6.3 | |
| D | 6.3 | 6.5 | |
| E | 6.5 | 6.7 | |
| F | 6.7 | 6.9 | |

 Luminous Flux Classifications ($I_F = 150\text{mA}$):

| Code | Min. | Max. | Unit |
|------|------|------|------|
| 2D | 114 | 122 | lm |
| 2E | 122 | 130 | |
| 2F | 130 | 139 | |

CIE CHROMATICITY DIAGRAM:

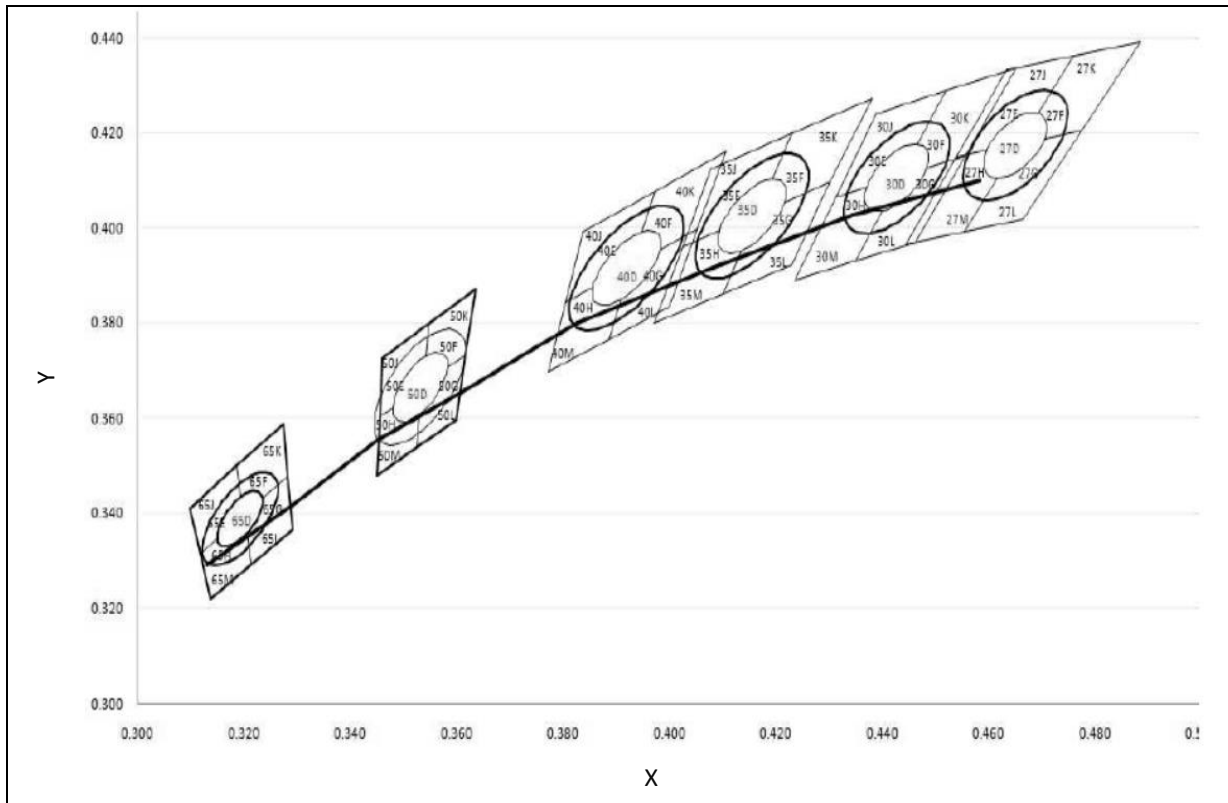

Chromaticity Coordinates Classifications ($I_F = 150\text{mA}$):

| Code | Centre | | Radius | | Angle |
|---------|--------|--------|---------|---------|--------|
| | X | Y | a | b | Φ |
| 50DEFHG | 0.3530 | 0.3665 | 0.00457 | 0.00197 | 59.37 |

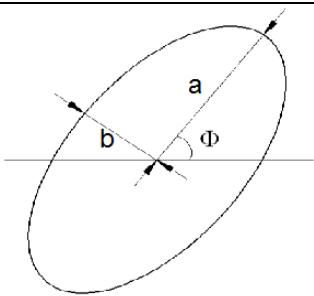

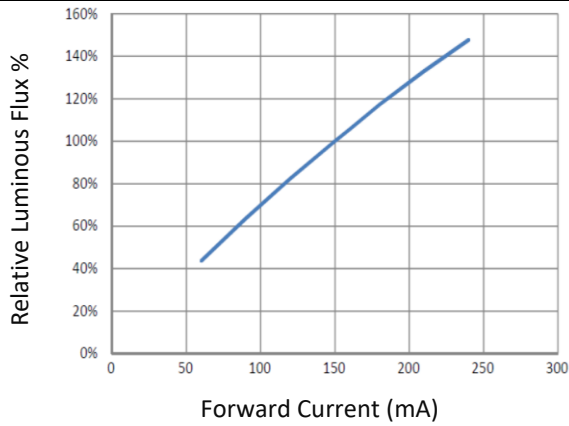
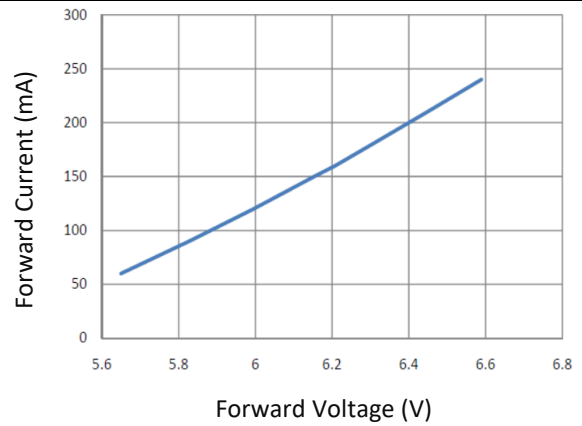
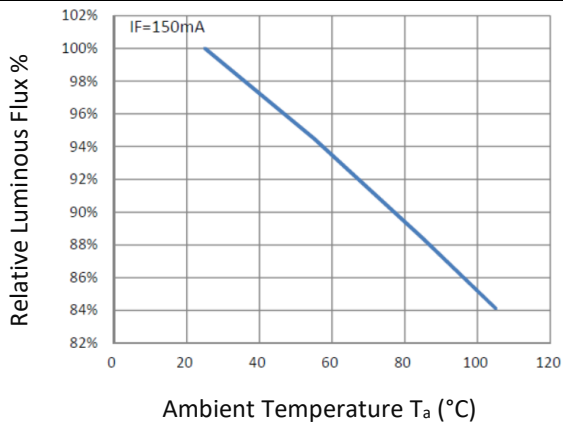
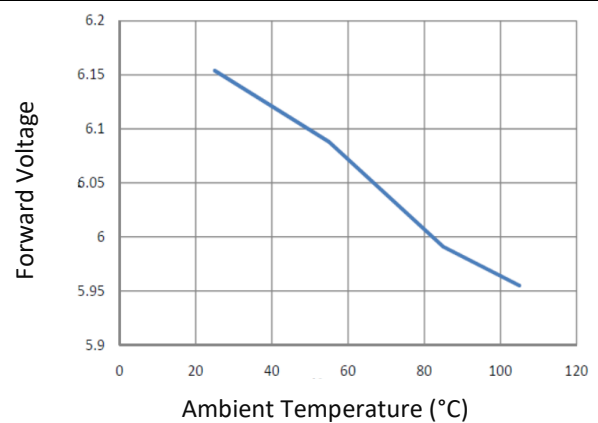
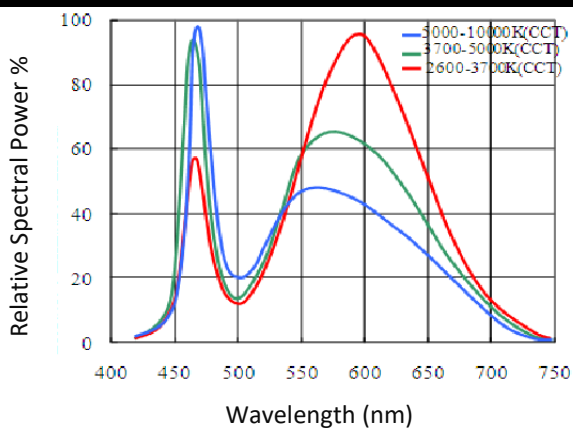
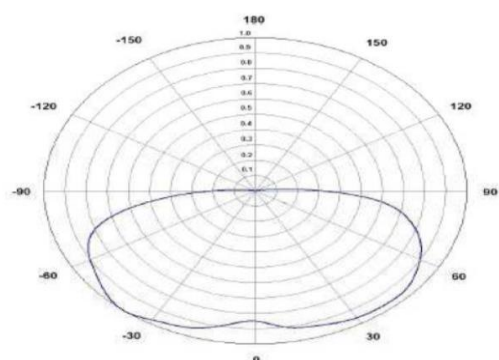
ELECTRO-OPTICAL CHARACTERISTICS:
Relative Luminous Flux v.s. Forward Current

Forward Current v.s. Forward Voltage

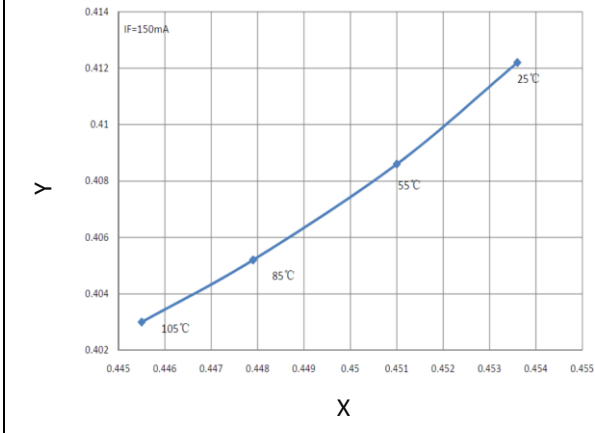
Relative Luminous Flux v.s. Ambient Temp.

Forward Voltage v.s. Ambient Temp.

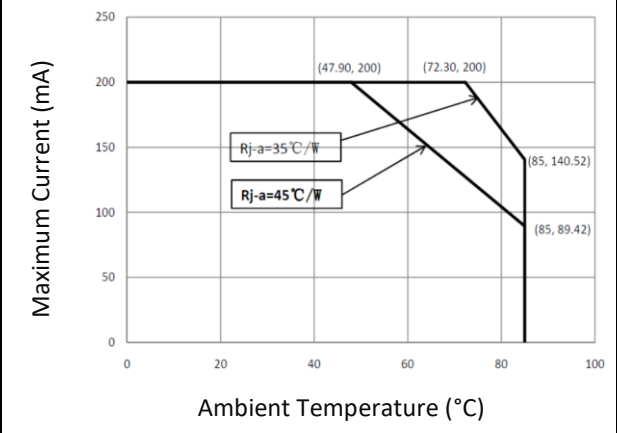
Relative Spectral Power v.s. Wavelength

Directive Radiation

Ambient Temperature v.s. CIE X, Y Shift



Forward Current Derating Curve



RECOMMENDED SOLDERING PROFILE:

Reflow Lead-free Solder:

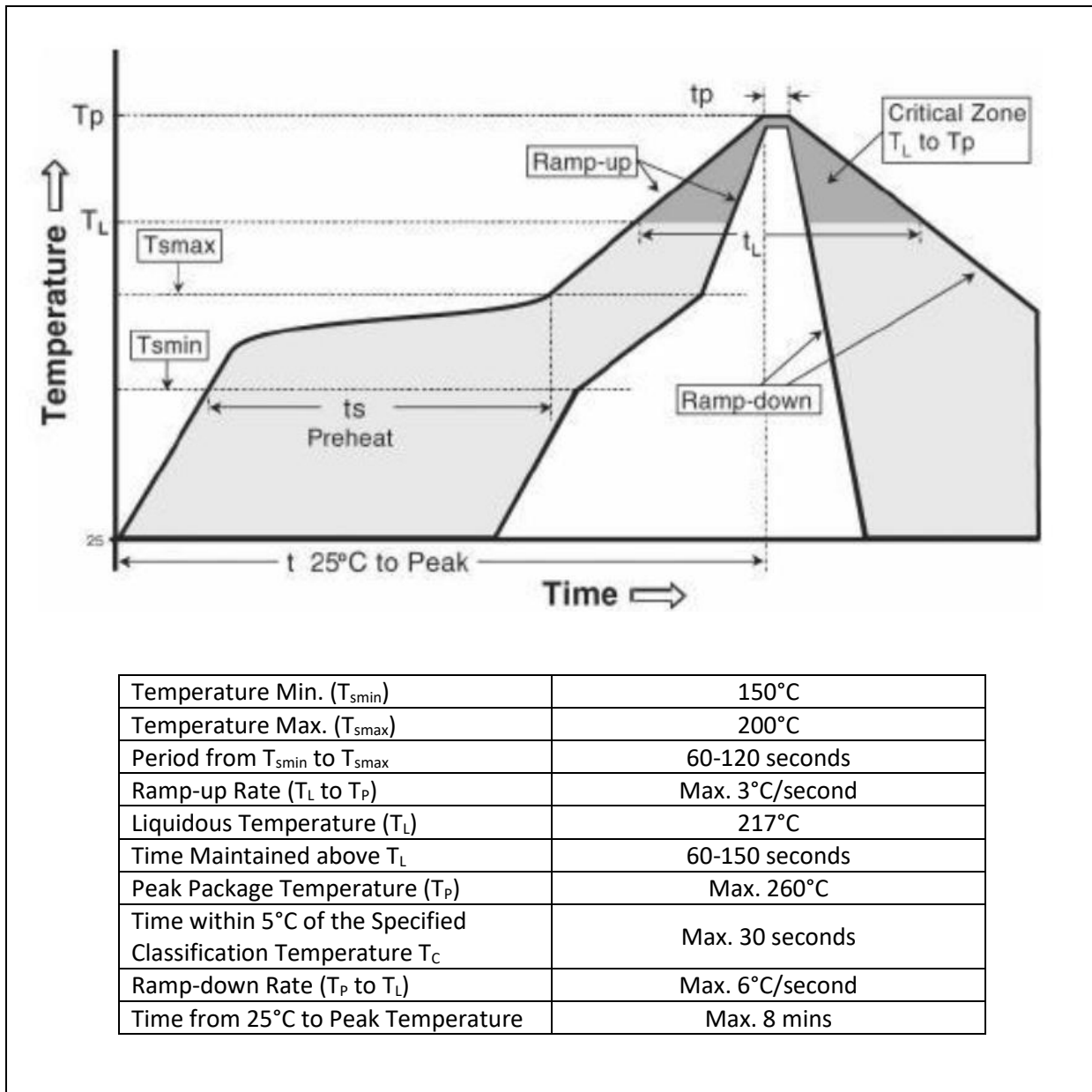

Note:

1. Maximum reflow soldering: 2 times.
2. Before, during, and after soldering, should not apply stress on the components and PCB board.
3. Recommended soldering temperature: 230°C. The maximum soldering temperature should be limited to 260°C for max. 10seconds.

PACKING SPECIFICATION:

Reel Dimension:

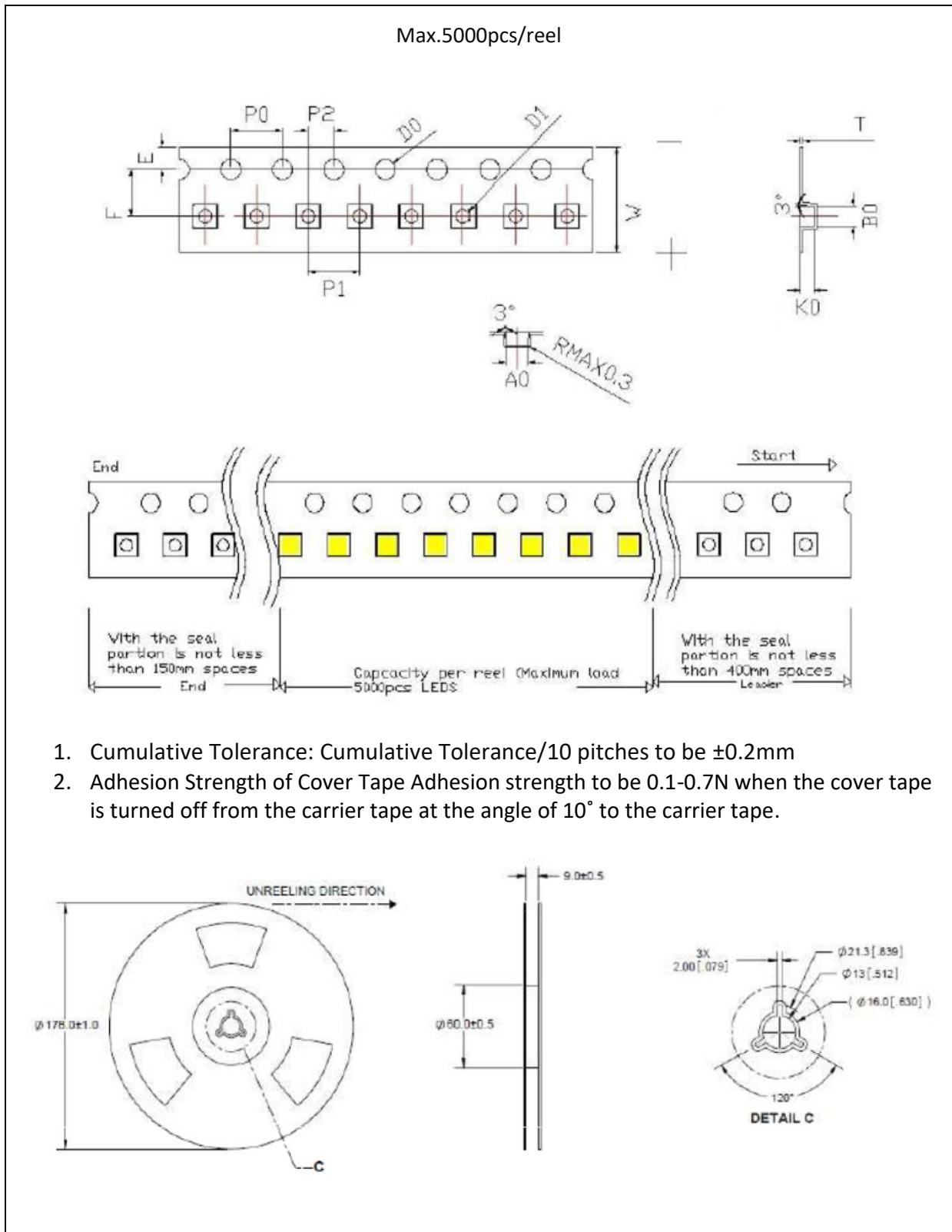

PRECAUTIONS OF USE:

Storage:

It is recommended to store the products in the following conditions:

- Humidity: 60% R.H. Max.
- Temperature: 5°C~30°C (41°F ~86°F).

Shelf life in sealed bag: 12 months at 5°C~30°C and <60% R.H.

Once the package is opened, the products should be used within a week. Otherwise, they should be kept in a damp-proof box with desiccating agent and apply baking at 60°C±5°C for 15hrs before use.

Baking:

It is recommended to bake the LED before soldering if the pack has been unsealed for longer than 24hrs. The suggested baking conditions are as followings:

- 60±3°C x 15hrs and <5%RH, taped / reel package.

It's normal to see slight color fading of carrier (light yellow) after baking in process.

Testing Circuit:

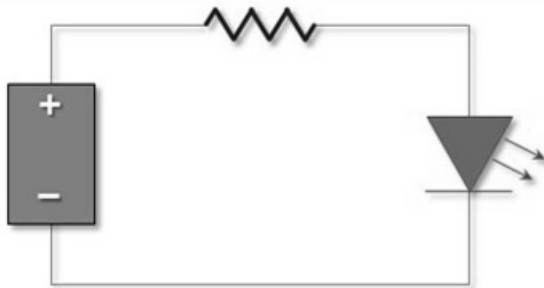

Must apply resistor(s) for protection (over current proof).

Cleaning:

Use alcohol-based cleaning solvents such as isopropyl alcohol to clean the LED carrier / package. Avoid putting any stress force directly on to the LED lens.

ESD (Electrostatic Discharge):

Static Electricity or power surge will damage the LED. Use of a conductive wrist band or anti-electrosatic glove is recommended when handling the LED all time. All devices, equipment, machinery, work tables, and storage racks must be properly grounded.

In the events of manual working in process, make sure the devices are well protected from ESD at any time.

REVISION RECORD:

| Version | Date | Summary of Revision |
|---------|------------|-----------------------|
| A1.0 | 04/01/2017 | Datasheet set-up. |
| A1.1 | 05/04/2018 | Revise binning range. |