



BRIGHTTEK
BRIGHTTEK (EUROPE) LIMITED

Brighten Up The World With LED!



ISO/TS 16949:2009



BS EN ISO 14001:2004



QC 080000 IECQ HSPM

PRODUCT DATASHEET



- ▶ EMC 2-PIN SMD
- ▶ 3030 0.52t
- ▶ Warm White (2700K)

NOW30S26



Release Date: 15 April 2018 Version: A1.1



3030 EMC Series

3030 EMC Series

RoHS
Compliant



FEATURES:

- **Package:** Top View EMC White Package
- **Forward Current:** 350mA
- **Forward Voltage (typ.):** 3.2V
- **Luminous Flux (typ.):** 136lm@350mA
- **Colour:** Warm White
- **Colour Temperature (CCT):** 2700K
- **Viewing angle:** 120°
- **Materials:**
 - Die: InGaN
 - Resin: Silicon (Yellow Diffused)
 - Package: EMC
- **Operating Temperature:** -40~+105°C
- **Storage Temperature:** -40~+105°C
- **Electrostatics Discharge:** 1000V
- **Grouping parameters:**
 - Forward Voltage
 - Luminous Flux
 - CIE Chromaticity
- **Soldering methods:** Reflow Soldering
- **MSL Level:** MSL3 according to J-STD020
- **Packing:** 8mm tape with Max.5000/reel, ø165mm (6.5")

APPLICATIONS:

- General Lighting
- Portable Lighting
- Commercial Lighting
- Indoor Lighting
- Backlight for LCD

CHARACTERISTICS:

Absolute Maximum Characteristics (Ta=25°C, RH=60%)

Parameter	Symbol	Ratings	Unit
DC Forward Current	I _F	400	mA
Pulse Forward Current (Duty 1/10, width≤100μS)	I _{PF}	600	mA
Power Dissipation	P _D	1360	mW
Reverse Voltage	V _R	5	V
Reverse Current @10V	I _R	10	μA
Junction Temperature	T _j	125	°C
Electrostatic Discharge	ESD	1000	V
Thermal Resistance (Junction to Solder Point)	R _{THJS}	18	°C/W
Operating Temperature	T _{OPR}	-40~+105	°C
Storage Temperature	T _{STG}	-40~+105	°C
Soldering Temperature	T _{SOL}	230/260 for 10S	°C
Colour Rendering Index	CRI	80	---

Electrical & Optical Characteristics (Ta=25°C, RH=60%)

Parameter	Symbol	Values			Unit	Test Condition
		Min.	Typ.	Max.		
Forward Voltage	V _F	---	3.2	3.4	V	I _F =350mA
Luminous Flux	Φ _v	122	136	---	lm	I _F =350mA
Chromaticity Coordinates	X	---	0.4620	---	---	I _F =350mA
	Y	---	0.4145	---		
Colour Temperature	CCT	2580	2725	2870	K	I _F =350mA
Viewing Angle	2θ _{1/2}	---	120	---	deg	I _F =350mA

1. Luminous flux (Φ_v) ±10%, Forward Voltage (V_F) ±0.1V, CRI ±2

OUTLINE DIMENSION:

Package Dimension:

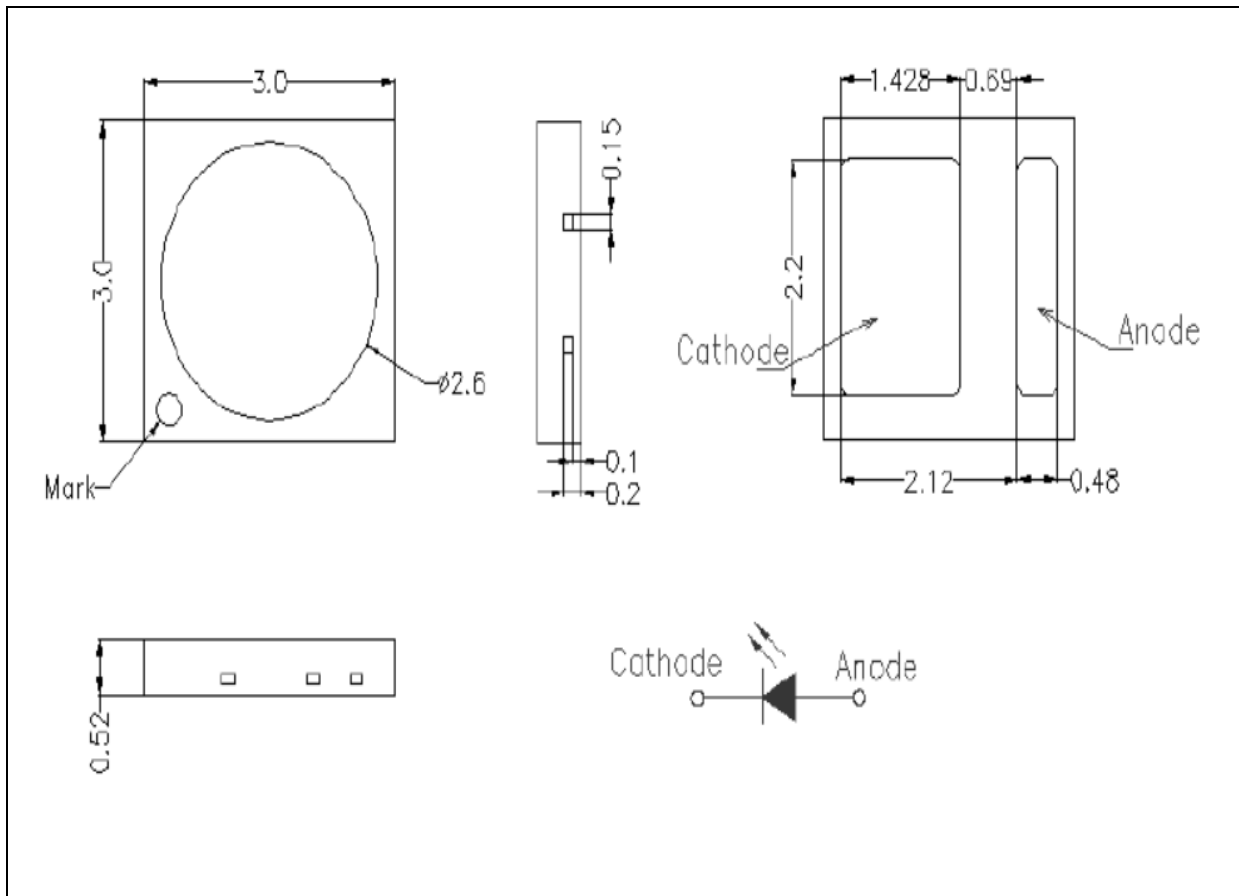

1. All dimensions are in millimetre (mm).
2. Tolerance ± 0.2 mm, unless otherwise noted.

Recommended Soldering Pad Dimension:

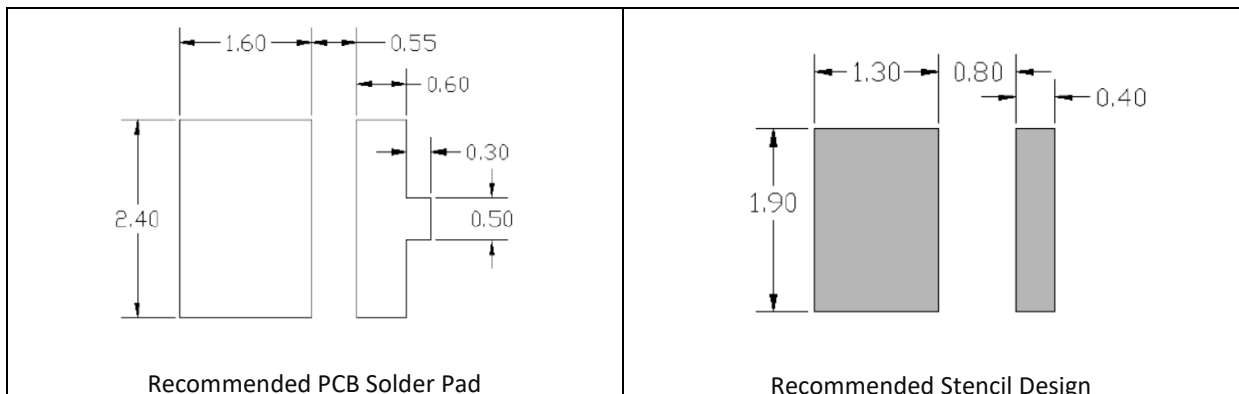

1. Dimensions are in millimetre (mm).
2. Tolerance ± 0.1 mm with angle tolerance $\pm 0.5^\circ$.

BINNING GROUPS:

 Forward Voltage Classifications ($I_F = 350\text{mA}$):

Code	Min.	Max.	Unit
H3	2.8	3.0	V
J3	3.0	3.2	
K3	3.2	3.4	

 Luminous Flux Classifications ($I_F = 350\text{mA}$):

Code	Min.	Max.	Unit
2E	122	130	lm
2F	130	139	
2G	139	148	

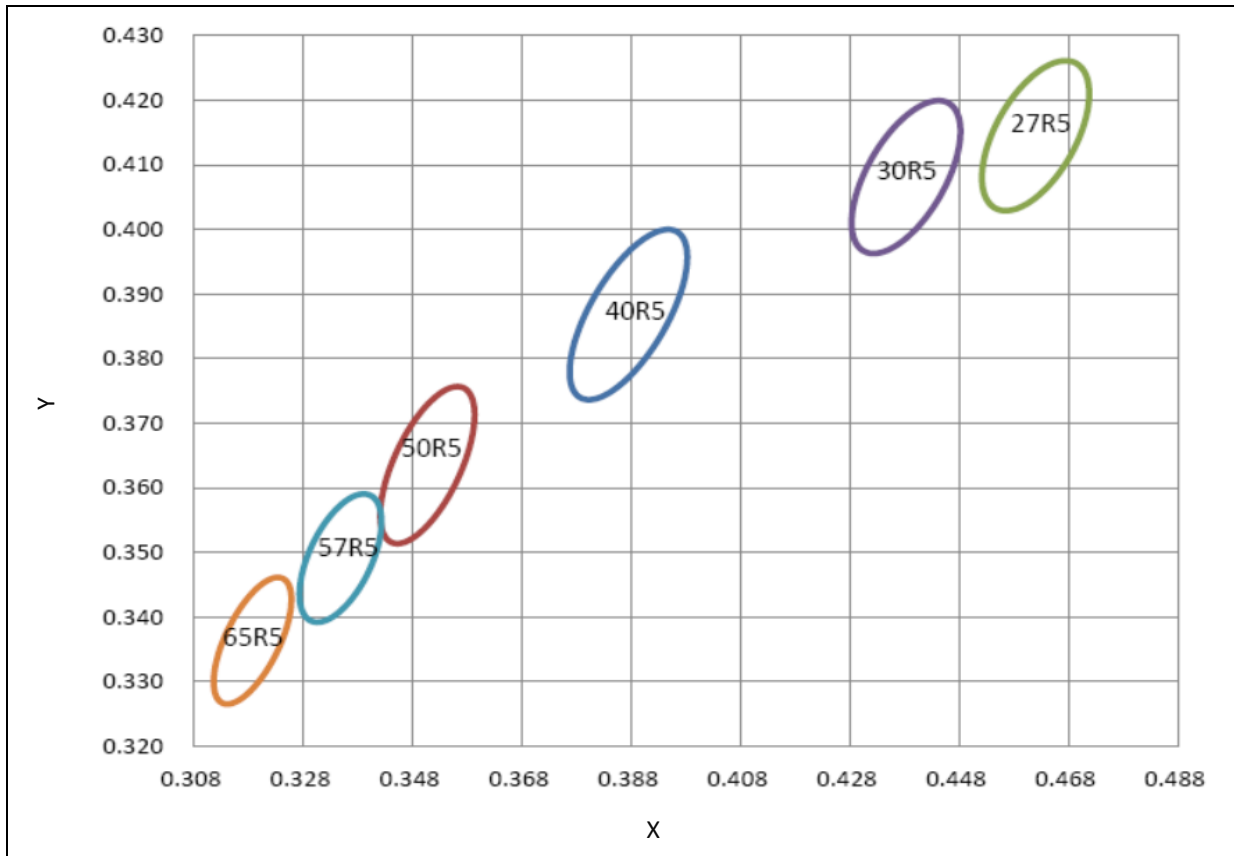
CIE CHROMATICITY DIAGRAM:

Chromaticity Coordinates Classifications ($I_F = 350\text{mA}$):

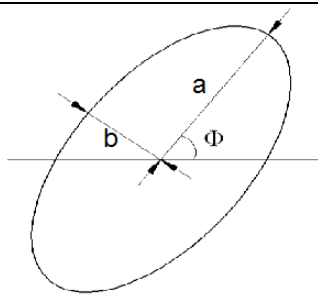
Code	Centre		Radius		Angle
	X	Y	a	b	Φ
27R5	0.4620	0.4145	0.013500	0.007000	53.42

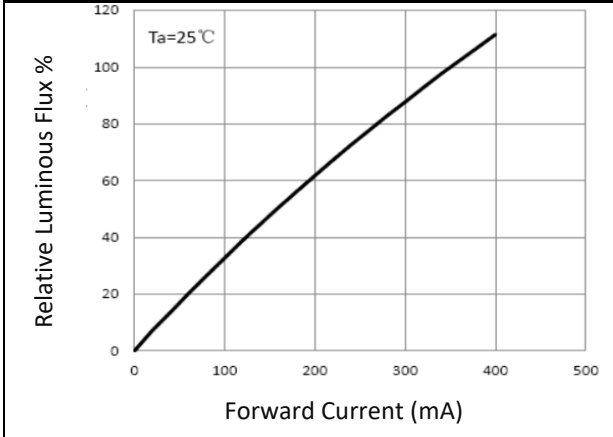

ELECTRO-OPTICAL CHARACTERISTICS:

Relative Luminous Flux v.s. Forward Current



Forward Current v.s. Forward Voltage

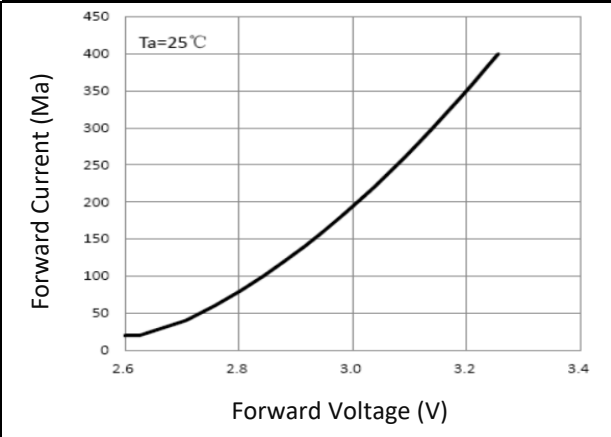

Relative Luminous Flux v.s. Temperature

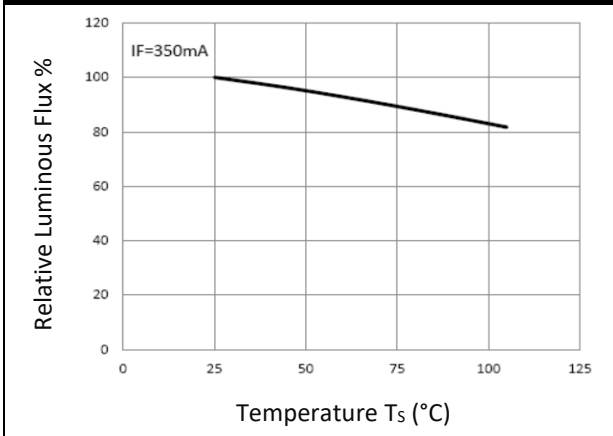

Forward Voltage v.s. Temperature

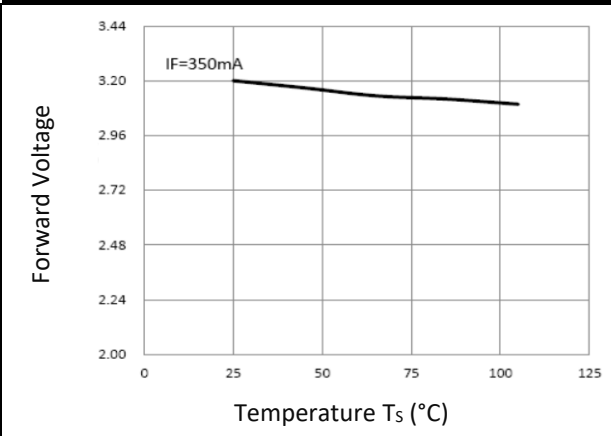

Relative Spectral Power v.s. Wavelength

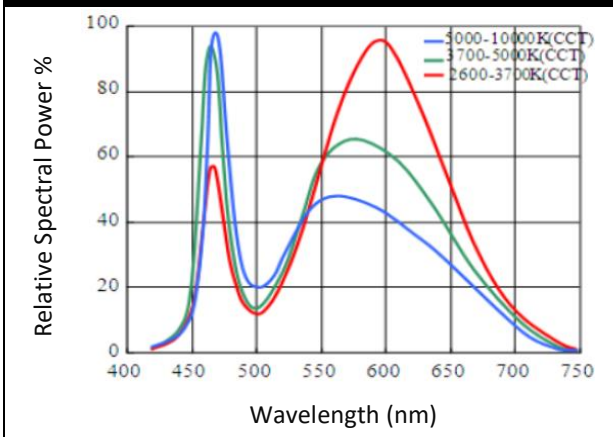

Directive Radiation

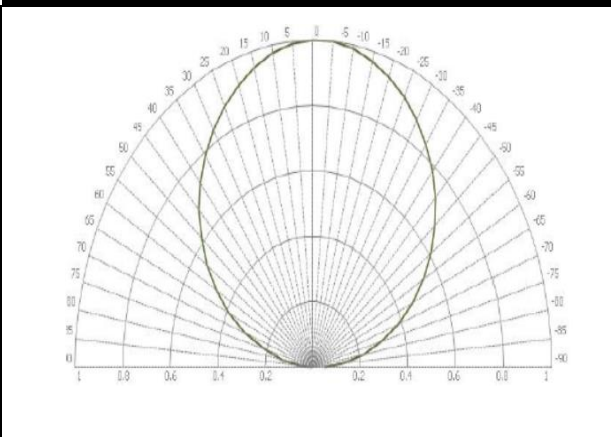

Ambient Temperature v.s. CIE X, Y Shift

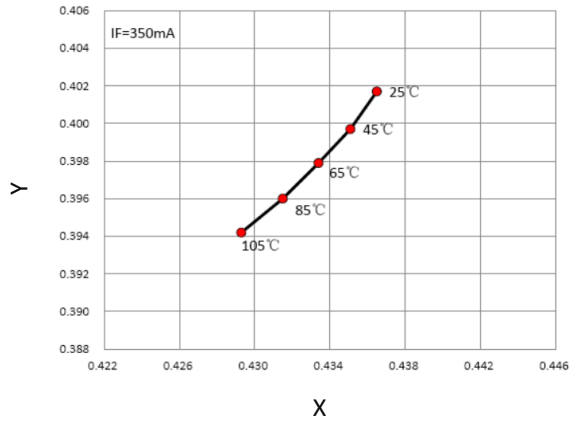

Forward Current Derating Curve

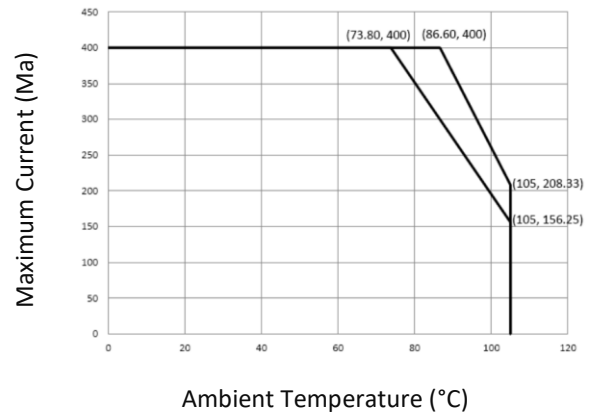

RECOMMENDED SOLDERING PROFILE:

Reflow Lead-free Solder:

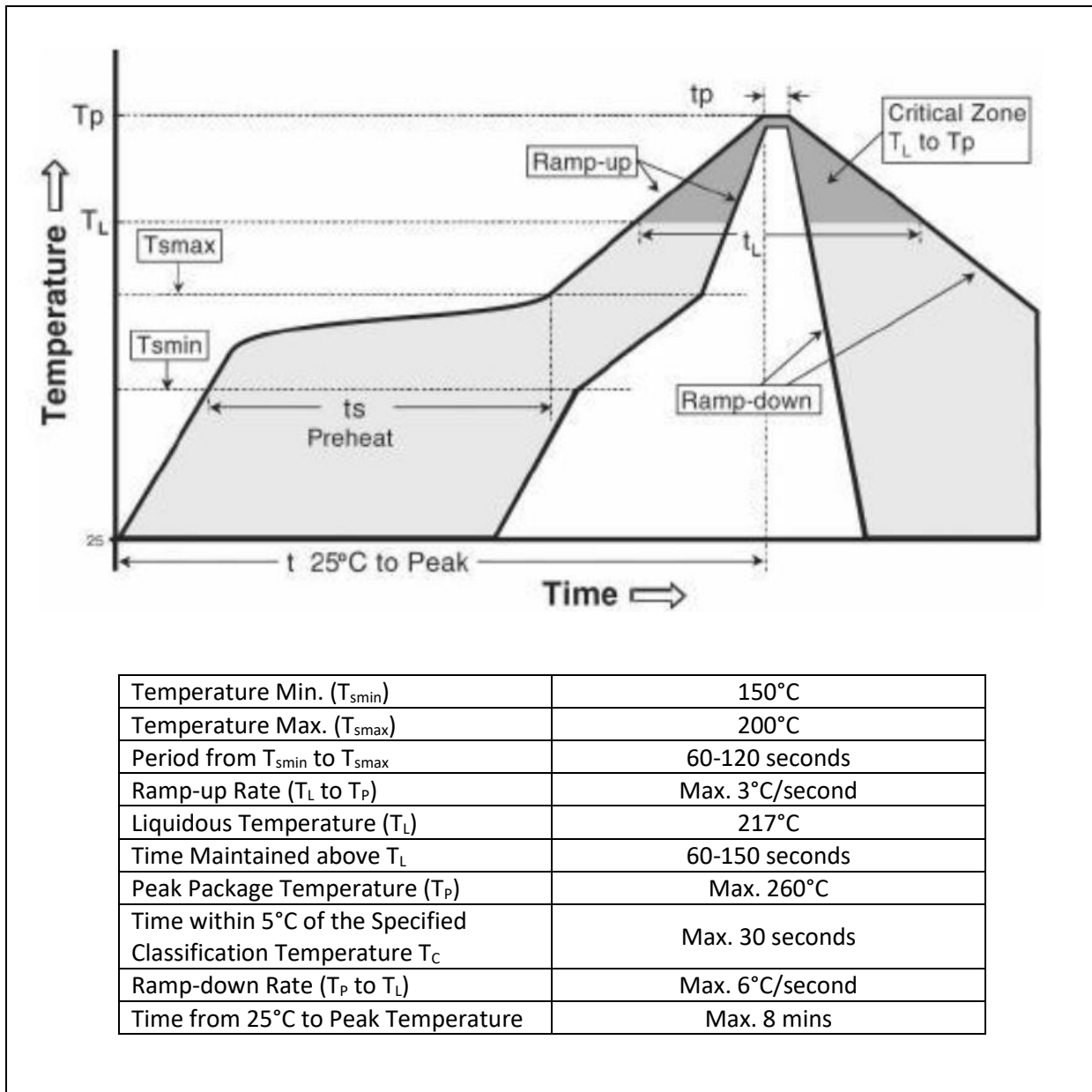

Note:

1. Maximum reflow soldering: 2 times.
2. Before, during, and after soldering, should not apply stress on the components and PCB board.
3. Recommended soldering temperature: 230°C. The maximum soldering temperature should be limited to 260°C for max. 10seconds.

PACKING SPECIFICATION:

Reel Dimension:

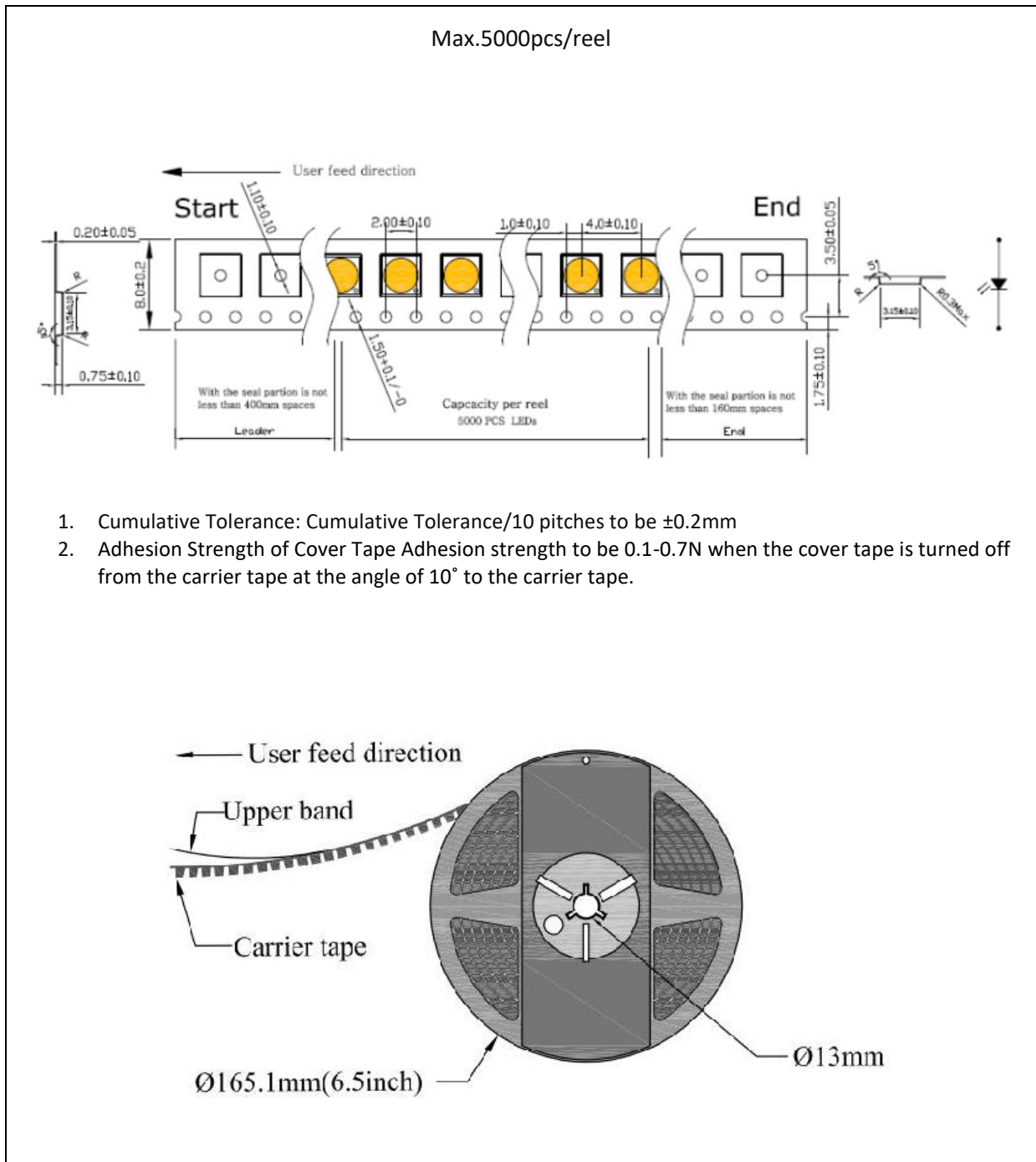

PRECAUTIONS OF USE:

Storage:

It is recommended to store the products in the following conditions:

- Humidity: 60% R.H. Max.
- Temperature: 5°C~30°C (41°F ~86°F).

Shelf life in sealed bag: 12 months at 5°C~30°C and <60% R.H.

Once the package is opened, the products should be used within a week. Otherwise, they should be kept in a damp-proof box with desiccating agent and apply baking at 60°C±5°C for 15hrs before use.

Baking:

It is recommended to bake the LED before soldering if the pack has been unsealed for longer than 24hrs. The suggested baking conditions are as followings:

- 60±3°C x 24hrs and <5%RH, taped / reel package.

It's normal to see slight color fading of carrier (light yellow) after baking in process.

Testing Circuit:

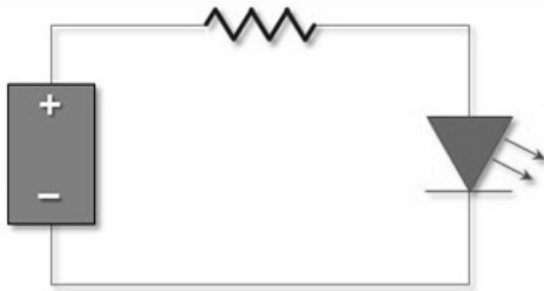

Must apply resistor(s) for protection (over current proof).

Cleaning:

Use alcohol-based cleaning solvents such as isopropyl alcohol to clean the LED carrier / package. Avoid putting any stress force directly on to the LED lens.

ESD (Electrostatic Discharge):

Static Electricity or power surge will damage the LED. Use of a conductive wrist band or anti-electrostatic glove is recommended when handling the LED all time. All devices, equipment, machinery, work tables, and storage racks must be properly grounded.

In the events of manual working in process, make sure the devices are well protected from ESD at any time.

REVISION RECORD:

Version	Date	Summary of Revision
A1.0	29/03/2017	Datasheet set-up.
A1.1	15/04/2018	Lead frame update.