

N0W06S96

◆Outline(L*W*H) : 5.0*5.0*1.6mm

◆Good thermal dissipation & optical uniformity

Table of Contents

Product Code Method -----	2
Maximum Rating-----	2
Typical Product Characteristics-----	3
Range of Bins-----	3
Color Coordinate Comparison -----	4
Electronic-optical Characteristics-----	5
Dimensions-----	6
Reflow Profile-----	7
Test Circuit and Handling Precautions-----	8
Packing-----	9
Precautions-----	11
Test Items and Results of Reliability-----	12

Features

- Forward current: $\leq 30*3\text{mA}$
- Typical view angle 50% Iv: 120°
- RoHS and REACH-compliant
- Qualified according to JEDEC moisturevity Level 5
- Lens color: yellowish
- ESD level 1KV(HBM)

Applications

- Indoor lighting applications
- Flat backlight for LCD. Switch and symbol
- Indicator and backlighting for all consumer electronics
- Others applications

■ Product Code Method

①	②	③	④	⑤
Process Type	Category	LED Type	Lead Frame Size	Dice wavelength & luminous rank
1: normal process	T: SMD LED	C: PLCC top view D: PLCC side view	50: 5.0*5.0mm 03: 3pcs Chip	Wxxx: white

⑥	⑦	⑧	⑨
Lap Polarity	Cap Color	PCB Module Code	Flow Code
2: parallel connection	W: yellowish	F: article mode	C3: no expression above meaning for company

■ Maximum Rating(Ta=25°C)

Characteristics	Symbol	Rating	Unit
DC Forward Current	I_F	30*3	mA
Pulse Forward Current ^{*3}	I_{PF}	80*3	mA
Reverse Voltage	V_R	5	V
Junction Temperature	T_J	110	°C
Operating Temperature Range	T_{OP}	-40-80	°C
Storage Temperature Range	T_{STG}	-40-100	°C
Soldering Temperature ^{*4}	T_{SD}	260	°C

Notes 1: There is no maximum or typical voltage parameter

2: For other ambient, limited setting of current will be depended on de-rating curves.

3: Duty 1/10, pulse width 0.1ms

4: The maximum of soldering time is 5 seconds in T_{SD}

■ Typical Product Characteristics(Ta=25°C)

Characteristics	Symbol	Min.	Typ.	Max.	Unit	Test condition
Forward Voltage	V_F	2.8	3.2	3.6	V	$I_F=20mA*3$
Luminous Intensity	I_v	4600	7000	-	mcd	$I_F=20mA*3$
Color Coordinate	x	-	0.4699	-	-	$I_F=20mA*3$
	y	-	0.4166	-		
Reverse Current	I_R	-	-	10	μA	$V_R=5V$
View Angle	$2\theta_{1/2}$	-	120	-	deg	$I_F=20mA*3$
Color Rendering Index	CRI	-	70	-	-	$I_F=20mA*3$

Notes: 1. Measurement Errors:

 Forward Voltage: $\pm 0.1V$, Luminous Intensity: $\pm 10\%I_v$, Color Coordinate: ± 0.006 , CRI ± 5

2. Electrical-Optical Characteristics (Ta=25°C)

■ Range of Bins
1).Forward Voltage ($I_F = 20mA*3$)

$V_F(V)$		
Bin Code	Min.	Max.
B	2.8	2.9
C	2.9	3.0
D	3.0	3.1
E	3.1	3.2
F	3.2	3.3
G	3.3	3.4
H	3.4	3.5
I	3.5	3.6

2).Luminous Intensity ($I_F = 20mA*3$)

$I_v(mcd)$		
Bin Code	Min.	Max.
21	4600	6000
22	6000	7800
23	7800	10100



■ Color Coordinate Comparison

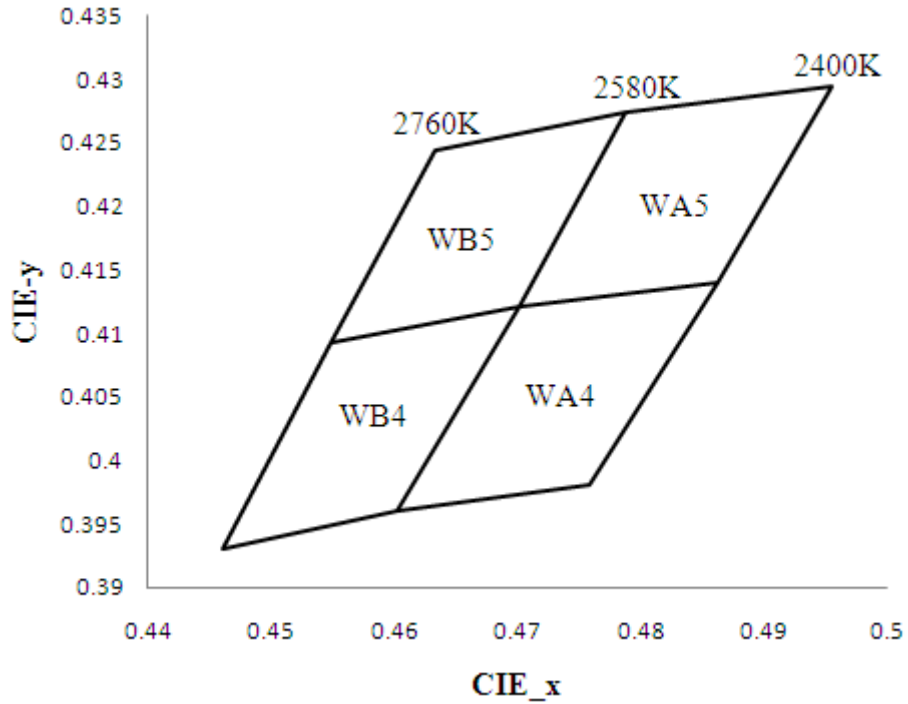

Color Rank

BIN	x	y	BIN	x	y
WA4	0.47	0.4121	WA5	0.4787	0.4274
	0.4601	0.396		0.47	0.4121
	0.4758	0.3981		0.4861	0.414
	0.4861	0.414		0.4954	0.4295
WB4	0.4548	0.4092	WB5	0.4633	0.4245
	0.446	0.393		0.4548	0.4092
	0.4601	0.396		0.47	0.4121
	0.47	0.4121		0.4787	0.4274



■ Electrical-Optical Characteristics

1). Relative Spectral Distribution

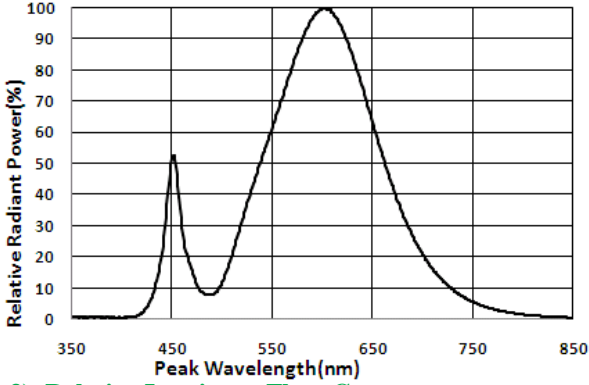

2). Typical Spatial Distribution

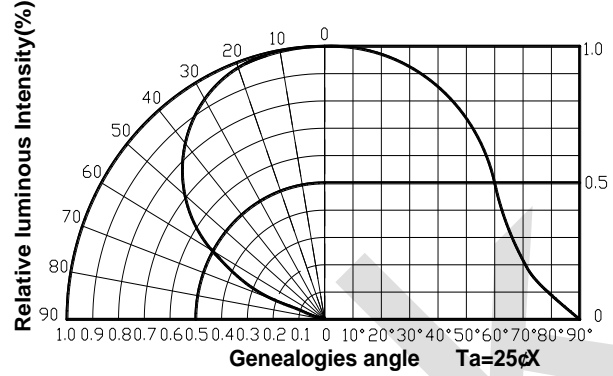

3). Relative Luminous Flux .Current

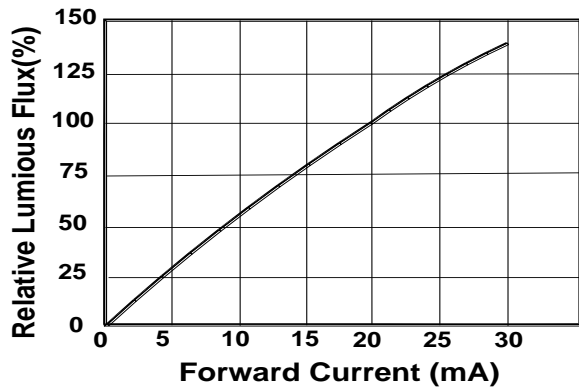

4). Relative Luminous Flux .Ambient Temperature

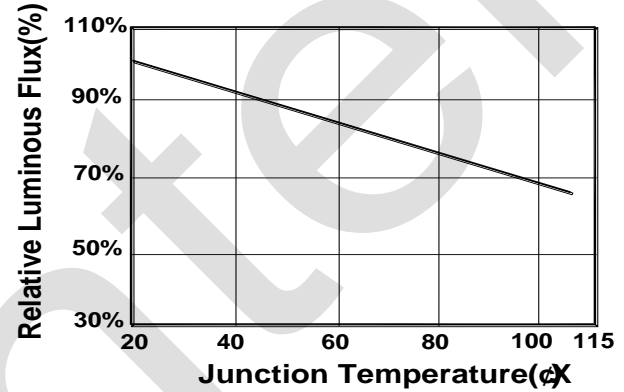

5). Electrical Characteristics

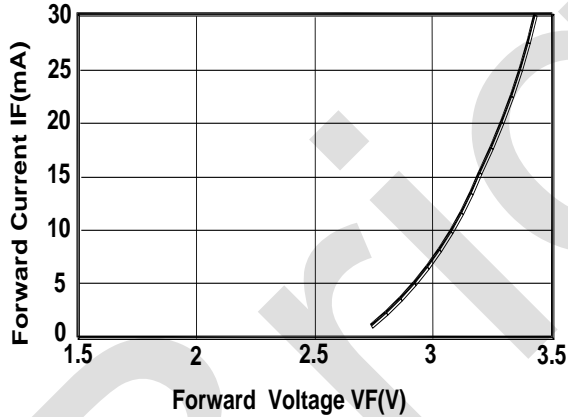

6). Relative Forward Voltage Temperature

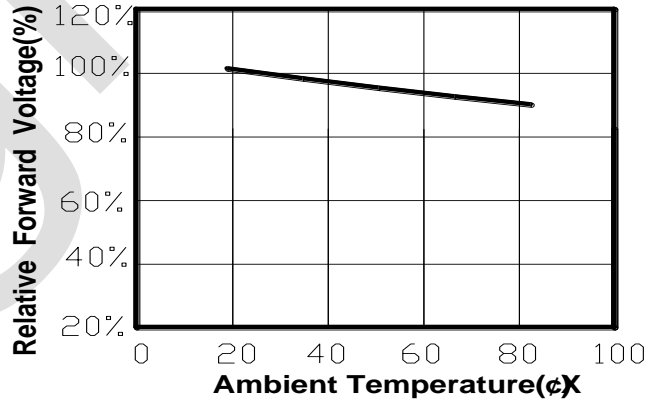

7). Relative Emission Efficiency. Current

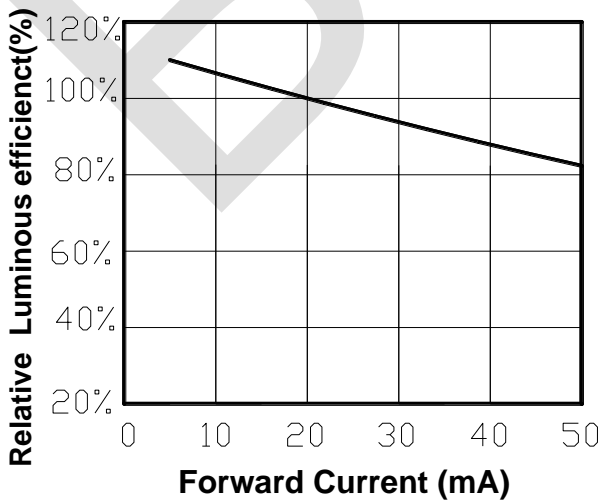

8). Thermal Design

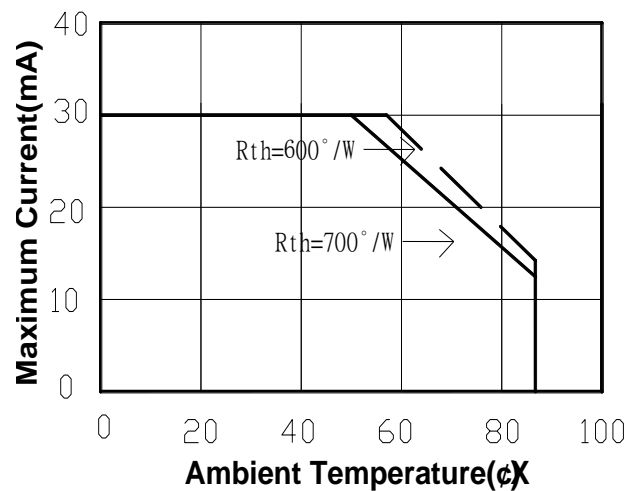

■ Dimensions

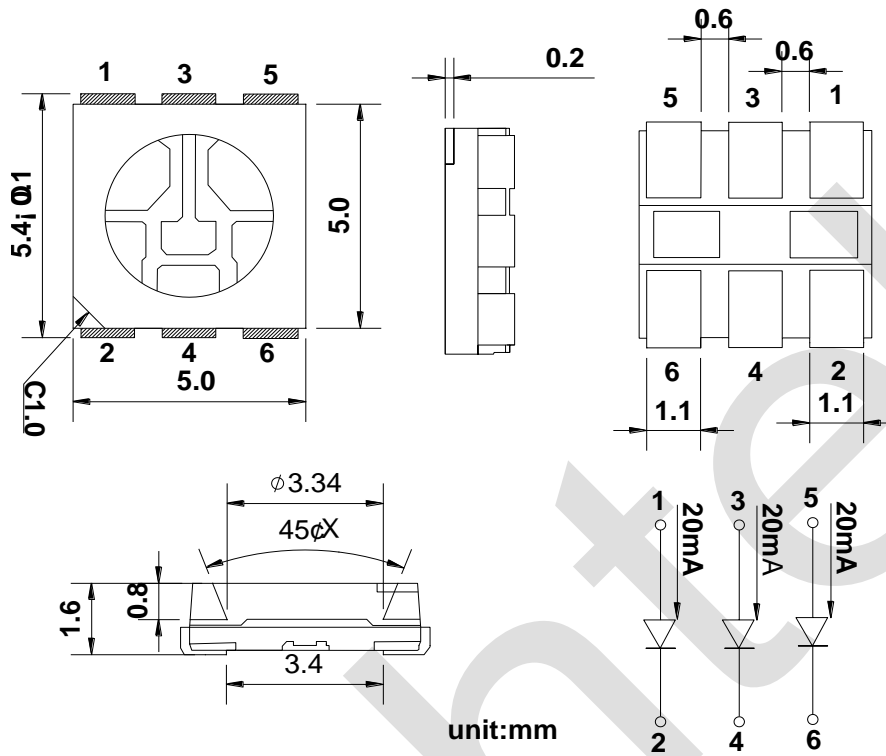

RECOMMEND PADLAYOUT

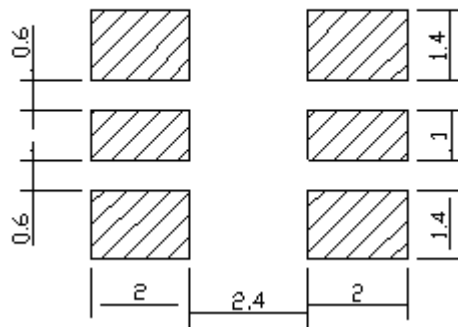

- Notes:
1. All dimensions are in millimeters
 2. Tolerance is ± 0.1 mm unless otherwise noted
 3. Specifications are subject to change without notice.

■ **Reflow Profile**

1. I_R reflow soldering profile for lead free solder

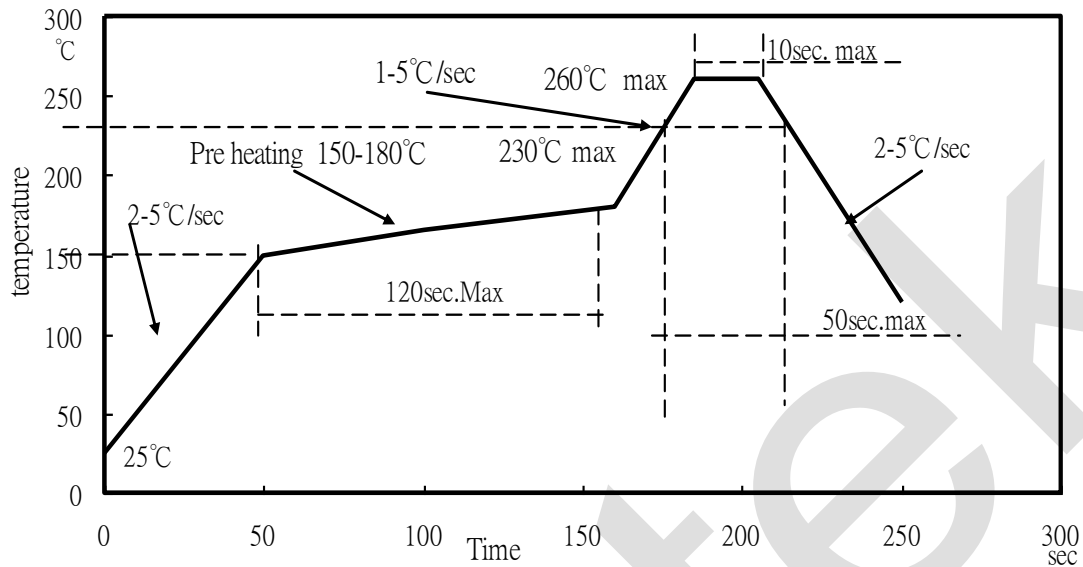

2. I_R reflow soldering profile for lead solder

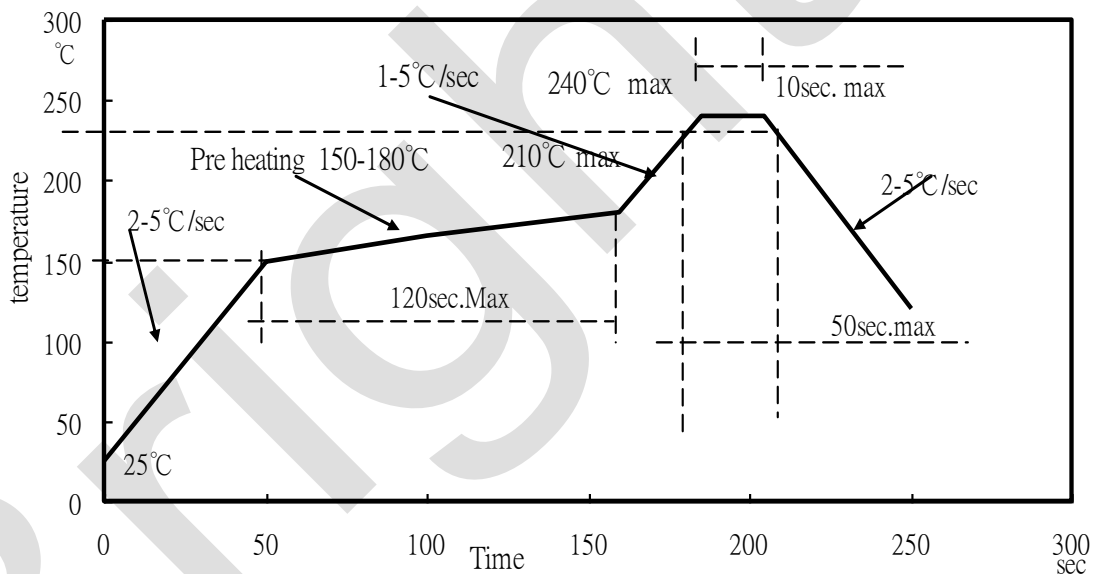

Notes:

1. We recommend the reflow temperature 240°C(±5°C).the maximum soldering temperature should be limited to 260°C.
2. Don't cause stress to the silicone resin while it is exposed to high temperature.
3. Number of reflow process shall be less than 3 times.

■ Test Circuit and Handling Precautions

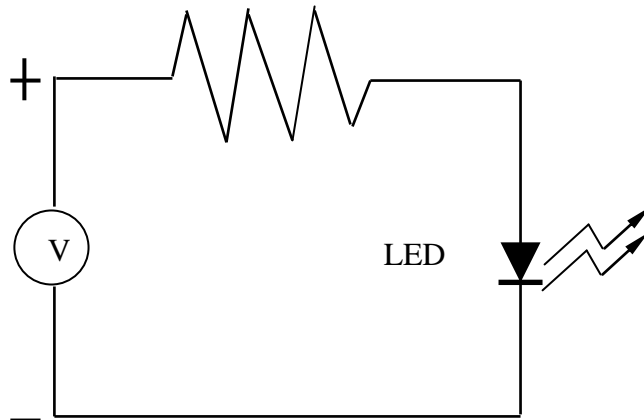
1. Test Circuit**2. Handling Precautions****2.1. Over-current-proof**

Customer must apply resistors for protection; otherwise slight voltage shift will cause big current change (Burn out will happen).

2.2. Storage

1). It is recommended to store the products in the following conditions:

Humidity: 60% R.H. Max.

Temperature: 5°C ~30°C (41°F ~86°F)

2). Shelf life in sealed bag: 12 month at <5°C~30°C and <60% R.H. after the package is Opened, the products should be used within a week or they should be keeping to stored at $\leq 20\%$ R.H. with zip-lock sealed.

2.3. Baking

It is recommended to baking before soldering when the pack is unsealed after 24hrs.

The Conditions are as followings:

1). 60±3°C X 6hrs and <5%RH, for reel

2). 125±3°C X 2hrs, for single LED

It shall be normal to see slight color fading of carrier (light yellow) after baking in process

■ Packing

● Feeding Direction (Unit: mm)

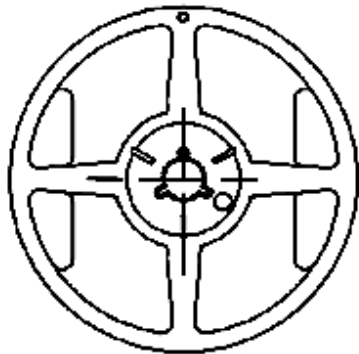

● Dimensions of Reel (Unit: mm)

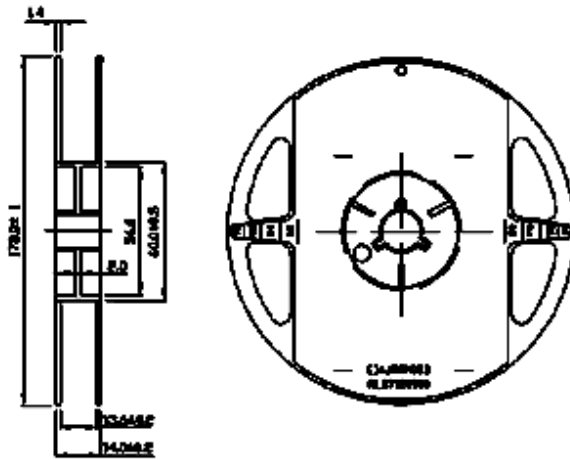

● Dimensions of Tape (Unit: mm)

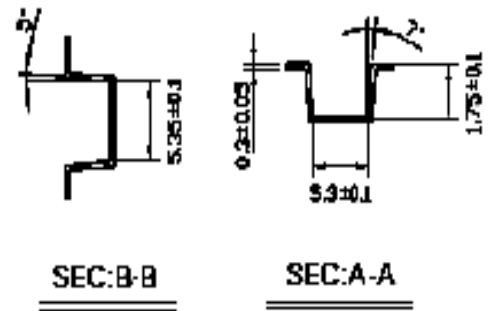
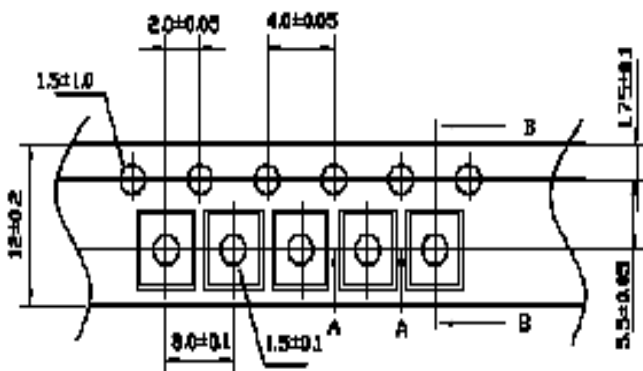

● Arrangement of Tape

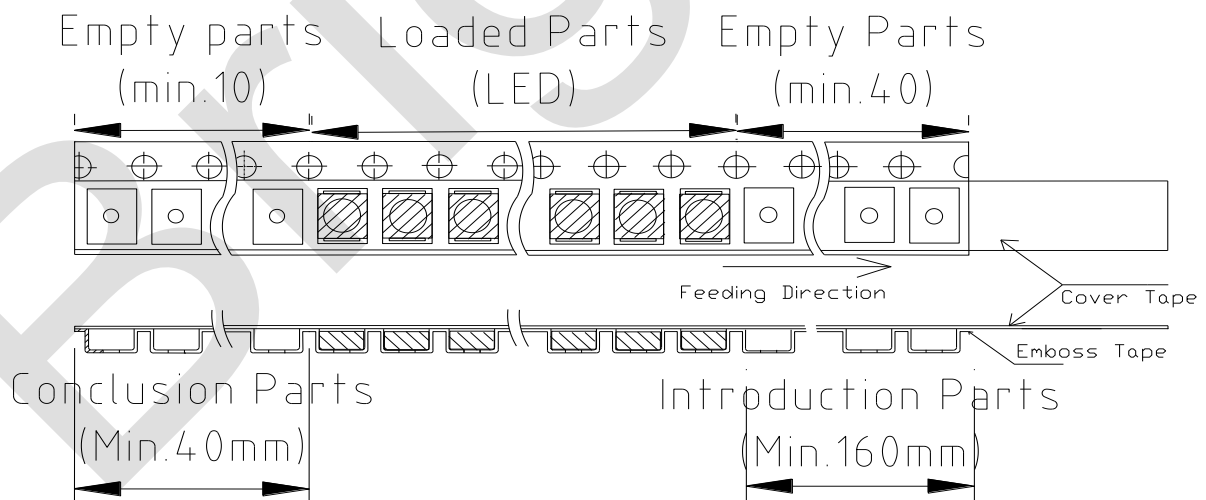

Notes:

1. Empty component pockets are sealed with top cover tape;
2. The max loss number of SMD is 2pcs;
3. The cathode is oriented towards the tape sprocket hole in accordance with ANSI/EIA RS-481 specifications;
4. 1,000pcs per reel

■ Packing

● Packaging Specifications

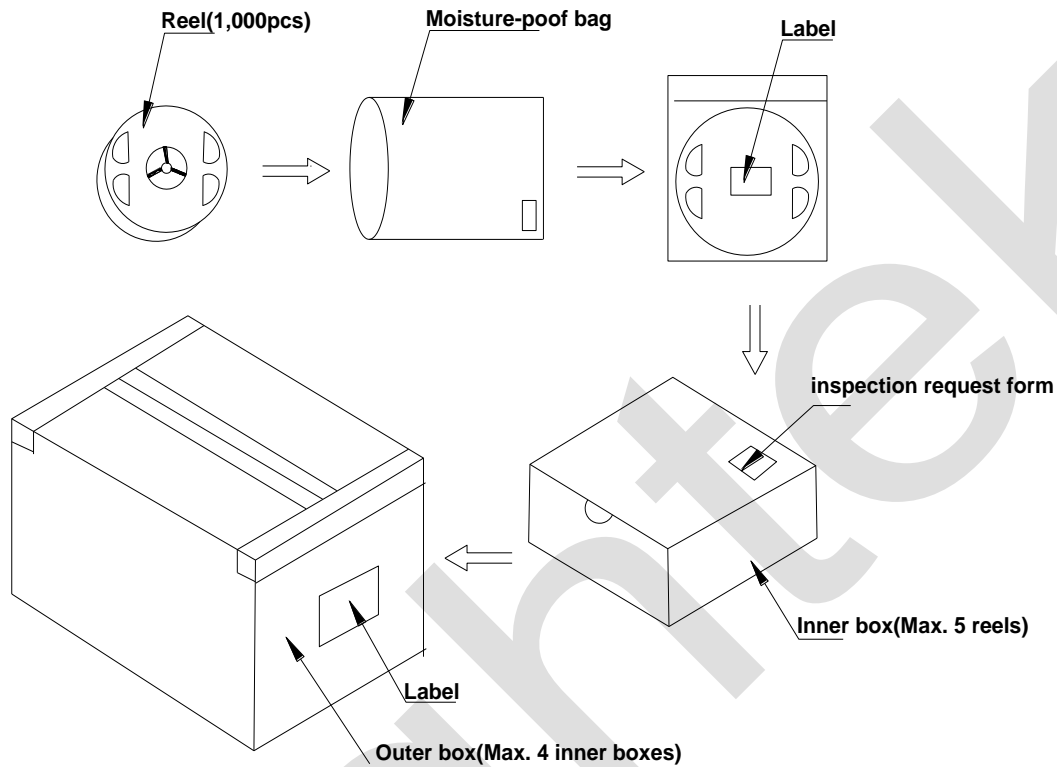

Notes:

Reeled product (max.1,000) is packed in a sealed moisture-proof bag. Five bags are packed in an inner box (size: about 260 X 230 X 100 mm) and four inner boxes are in an outer box (size: about 480 X 275 X 215 mm). On the label of moisture-proof bag, there should be the information of Part No., Lot No. and quantity number; also the total quantity number should be on inspection request form on outer box.

■ Precautions

1. Abnormal situation caused by improper setting of collet

To choose the right collet is the key issue in improving the product's quality. LED is different from other electronic components, which is not only about electrical output but also for optical output. This characteristic made LED more fragile in the process of SMT. If the collet's lowering down height is not well set, it will bring damage to the gold wire at the time of collet's picking up and loading which will cause the LED fail to light up, light up now and then or other quality problems

2. How to choose the collet

During SMT, please choose the collet that has larger outer diameter than the lighting area of lens, in case that improper position of collet will damage the gold wire inside the LED. Different collets fit for different products, please refer to the following pictures cross out

Outer diameter of collet should be larger than the lighting area

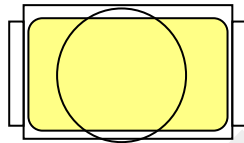

Picture 1(√)

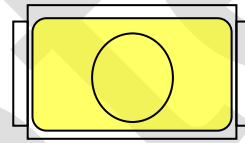

Picture 2(X)

3. Other points for attention

- A. No pressure should be exerted to the epoxy shell of the SMD under high temperature.
- B. Do not scratch or wipe the lens since the lens and gold wire inside are rather fragile and cross out easy to break.
- C. LED should be used as soon as possible when being taken out of the original package, and should be stored in anti-moisture and anti-ESD package.

4. This usage and handling instruction is only for your reference.

■ Test Items and Results of Reliability

Test Item	Test Conditions	Duration/ Cycle	Number of Damage	Reference
Temperature Cycle	-40°C 30min ↑↓ 1 min 85°C 30min	100 cycles	0/22	JEITA ED-4701 300 303
High Temperature Storage	T _a =100°C±5°C	1000 hrs	0/22	EIAJED-4701 200 201
High Humidity Heat Life Test	T _a =85°C RH=85% I _F =20*3mA	500 hrs	0/22	Tested with Brightek standard
Humidity Heat Storage	T _a =85°C RH=85%	1000 hrs	0/22	EIAJED-4701 100 103
Life Test	T _a =25°C I _F =20*3mA	1000 hrs	0/22	Tested with Brightek standard
Low Temperature Life Test	T _a =-40°C I _F =20*3mA	1000 hrs	0/22	Tested with Brightek standard
High Temperature Life Test	T _a =85°C I _F =20*3mA	1000 hrs	0/22	Tested with Brightek standard

*Criteria for Judging				
Item	Symbol	Condition	Criteria for Judgment of Pass	
			Min	Max
Forward Voltage	V _F	I _F =20mA*3	-	USL* ¹ ×1.1
Reverse Current	I _R	V _R = 5V	-	10μA
Luminous Intensity	I _v	I _F =20mA*3	LSL* ² ×0.7	-

[Note] USL*¹: Upper Specification Level

LSL*²: Lower Specification Level