



BRIGHTTEK
BRIGHTTEK (EUROPE) LIMITED

Brighten Up The World With LED!



ISO/TS 16949:2009



BS EN ISO 14001:2004



QC 080000 IECQ HSPM

PRODUCT DATASHEET



- ▶ PLCC2 SMD
- ▶ 2835 0.8t Series
- ▶ Cool White (6000K)

NOW04S24



Release Date: 31 March 2015 Version: A1.0

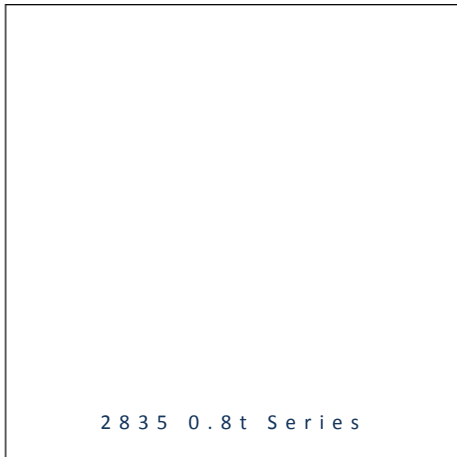

2835 0.8t Series

2835 0.8t Series

RoHS
Compliant



FEATURES:

- **Package:** PLCC2 White SMD Package
- **Forward Current:** 60mA
- **Forward Voltage (typ.):** 3.1V
- **Luminous Flux (typ.):** 17lm@60mA
- **Colour:** Cool White
- **Colour Temperature (CCT):** 6000K
- **Viewing angle:** 120°
- **Materials:**
 - Die: InGaN
 - Resin: Silicon (Yellow Diffused)
 - L/T Finish: Ag plated
- **Operating Temperature:** -40~+80°C
- **Storage Temperature:** -40~+100°C
- **Grouping parameters:**
 - Forward Voltage
 - Luminous Flux
 - CIE Chromaticity
- **Soldering methods:** Reflow Soldering
- **Preconditioning:** MSL3 according to JEDEC
- **Packing:** 8mm tape with 4000/reel, ø180mm (7")

APPLICATIONS:

- General Lighting
- Portable Lighting
- Commercial Lighting
- Indoor Lighting
- Backlight for LCD

CHARACTERISTICS:

Absolute Maximum Characteristics (Ta=25°C)

Parameter	Symbol	Ratings	Unit
DC Forward Current	I_F	100	mA
Reverse Current @5V	I_R	10	μ A
Junction Temperature	T_j	110	°C
Operating Temperature	T_{OPR}	-40~+80	°C
Storage Temperature	T_{STG}	-40~+100	°C
Soldering Temperature	T_{SOL}	260	°C
Colour Rendering Index	CRI	90 (typ.)	---

Electrical & Optical Characteristics (Ta=25°C)

Parameter	Symbol	Values			Unit	Test Condition
		Min.	Typ.	Max.		
Forward Voltage	V_F	2.8	3.1	3.6	V	$I_F=60$ mA
Luminous Flux	Φ_V	14	17	22	lm	$I_F=60$ mA
Chromaticity Coordinates	X	---	0.3176	---	---	$I_F=60$ mA
	Y	---	0.3261	---		
Colour Temperature	CCT	5450	6000	6650	K	$I_F=60$ mA
Viewing Angle	$2\theta_{1/2}$	---	120	---	deg	$I_F=60$ mA

- Luminous flux (Φ_V) $\pm 10\%$, Forward Voltage (V_F) $\pm 0.1V$, Viewing angle($2\theta_{1/2}$) $\pm 5\%$, CRI ± 5
- IS standard testing

OUTLINE DIMENSION:

Package Dimension:

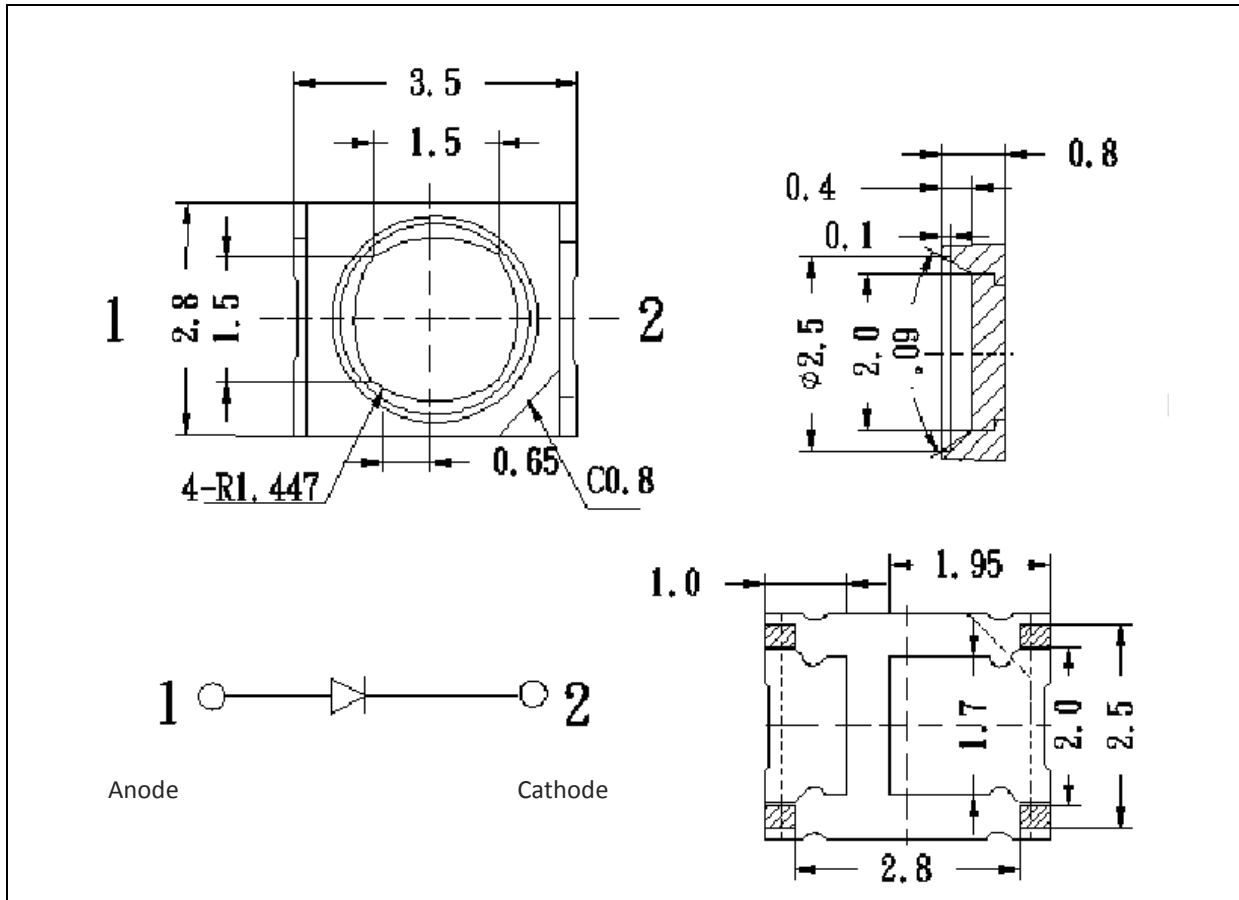

1. All dimensions are in millimetre (mm).
2. Tolerance ± 0.13 mm, unless otherwise noted.

Recommended Soldering Pad Dimension:

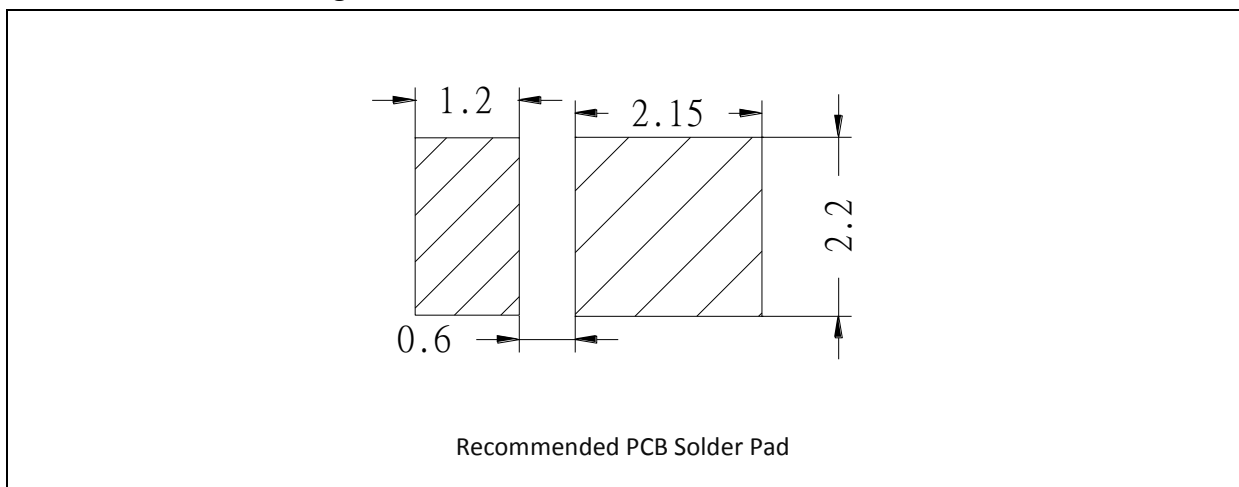

1. Dimensions are in millimetre (mm).
2. Tolerance ± 0.1 mm with angle tolerance $\pm 0.5^\circ$.

BINNING GROUPS:

 Forward Voltage Classifications ($I_F = 60\text{mA}$):

Code	Min.	Max.	Unit
B	2.8	2.9	V
C	2.9	3.0	
D	3.0	3.1	
E	3.1	3.2	
F	3.2	3.3	
G	3.3	3.4	
H	3.4	3.5	
I	3.5	3.6	

 Luminous Flux Classifications ($I_F = 60\text{mA}$):

Code	Min.	Max.	Unit
13	14	16	lm
14	16	18	
15	18	20	
16	20	22	

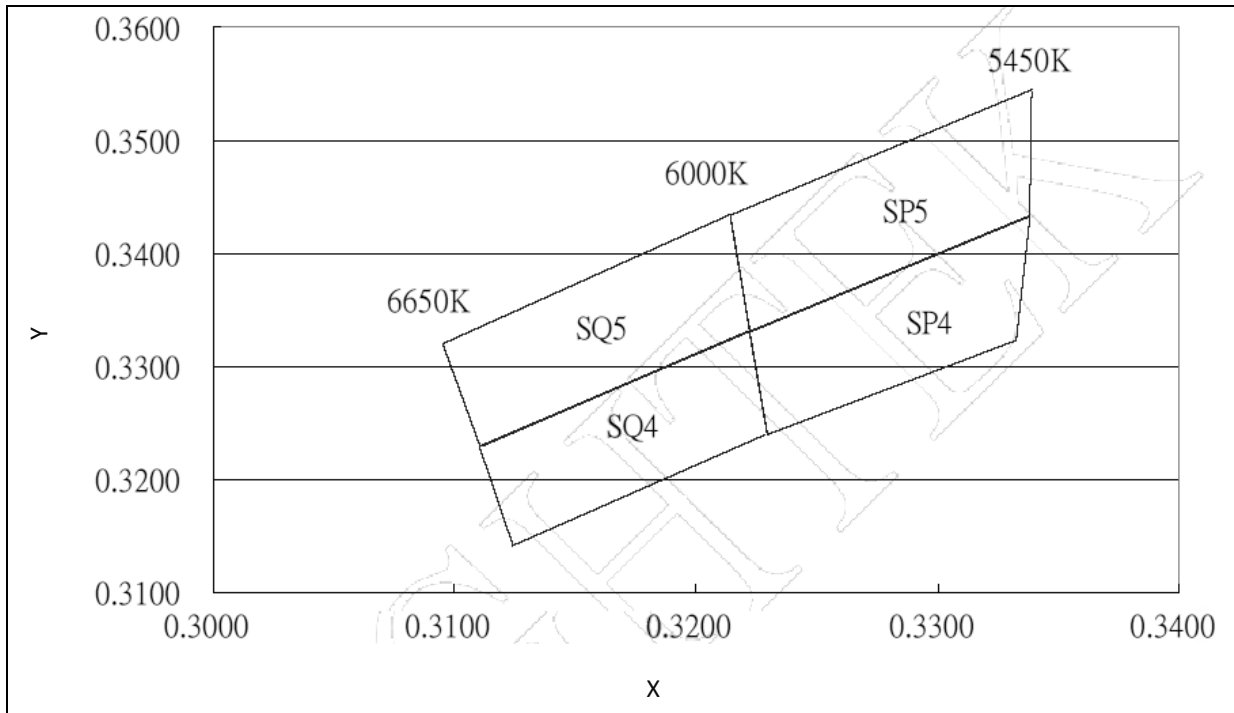
CIE CHROMATICITY DIAGRAM:

Chromaticity Coordinates Classifications ($I_F = 60\text{mA}$):

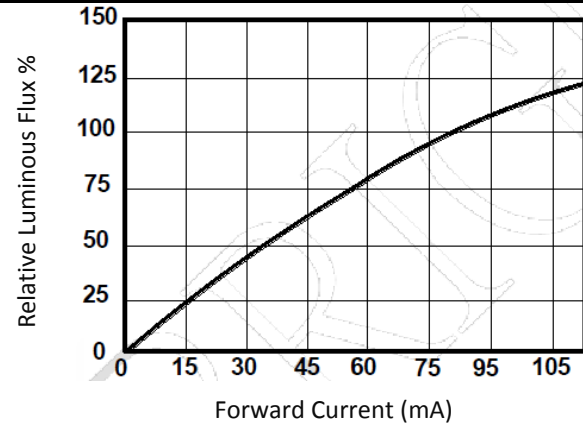
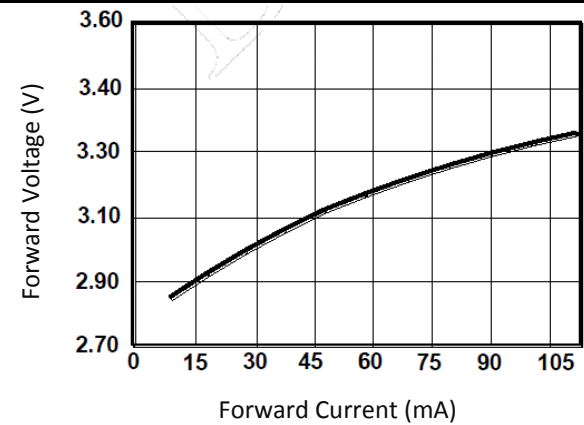
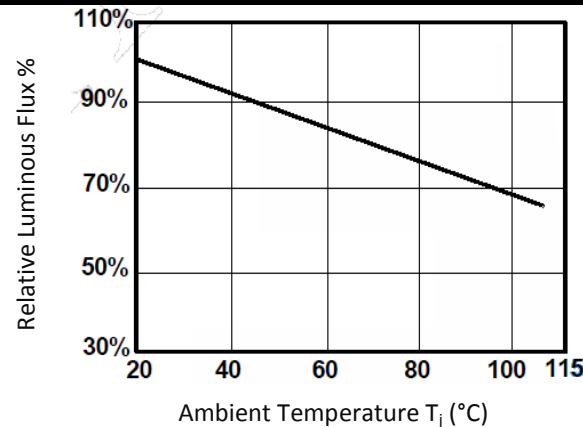
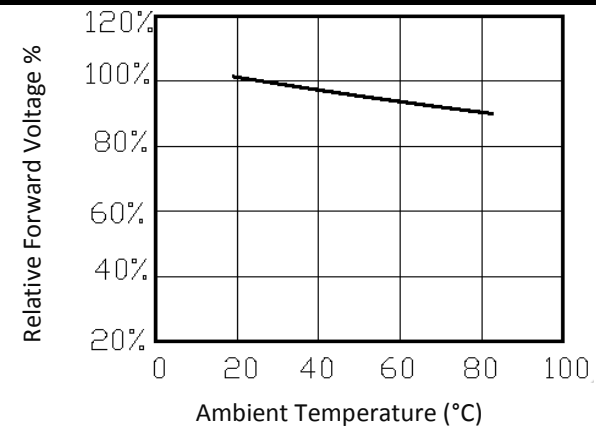
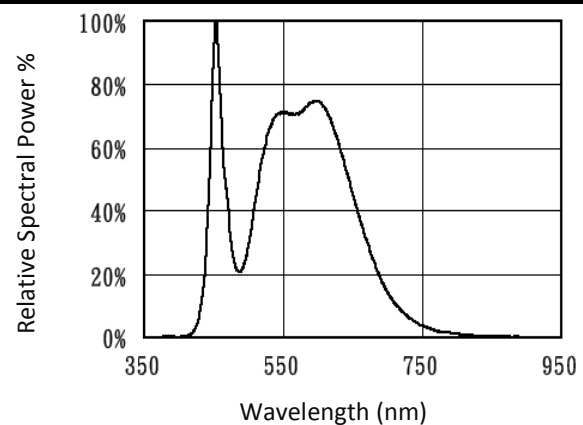
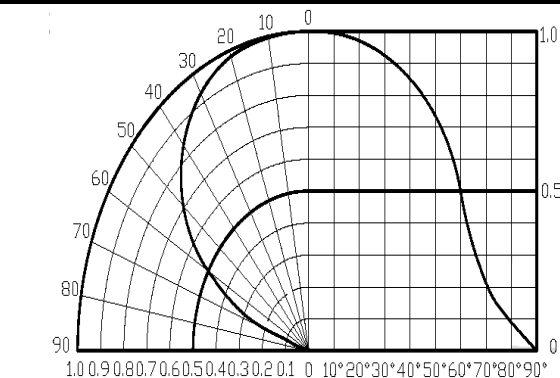
	1		2		3		4	
	X	Y	X	Y	X	Y	X	Y
SP4	0.3222	0.3331	0.3229	0.3240	0.3332	0.3323	0.3338	0.3432
SP5	0.3214	0.3434	0.3222	0.3331	0.3338	0.3432	0.3339	0.3545
SQ4	0.3110	0.3230	0.3124	0.3142	0.3229	0.3240	0.3222	0.3331
SQ5	0.3095	0.3320	0.3110	0.3230	0.3222	0.3331	0.3214	0.3434

ELECTRO-OPTICAL CHARACTERISTICS:
Relative Luminous Flux v.s. Forward Current

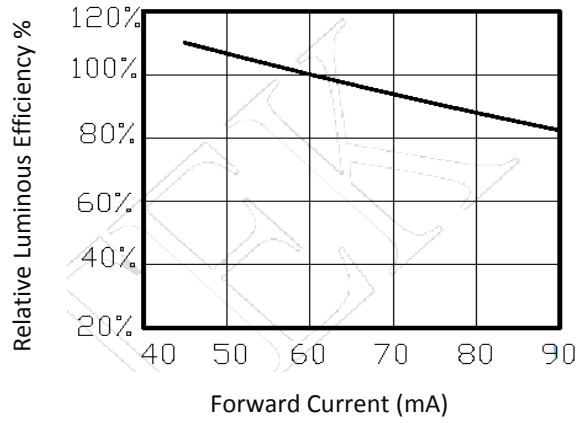
Forward Current v.s. Forward Voltage

Relative Luminous Flux v.s. Ambient Temp.

Relative Forward Voltage v.s. Ambient Temp.

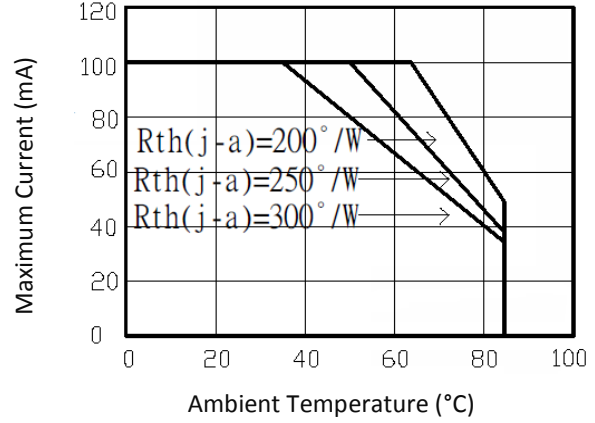
Relative Spectral Power v.s. Wavelength

Directive Radiation

Relative Emission Efficiency v.s. Forward Current



Forward Current Derating Curve



RECOMMENDED SOLDERING PROFILE:

IR Reflow Lead-free Solder:

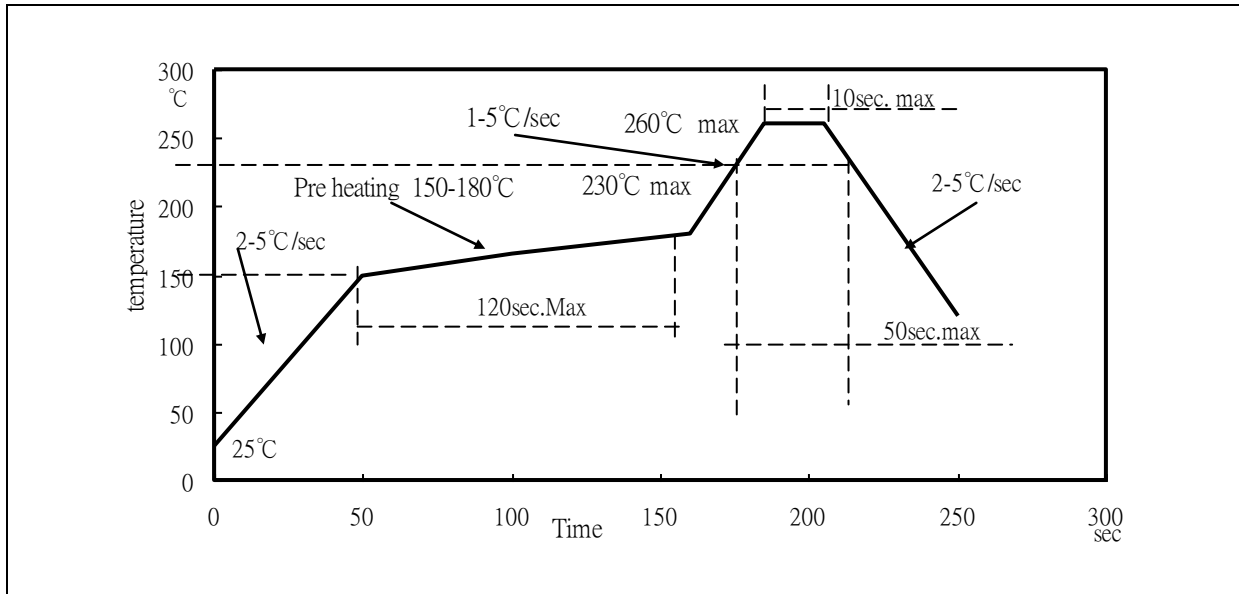

Note:

1. Maximum reflow soldering: 1 time.
2. Recommended reflow temperature: 240°C. Maximum soldering temperature should be limited to 260°C.
3. Before, during, and after soldering, should not apply stress on the components and PCB board.

PACKING SPECIFICATION:

Reel Dimension:

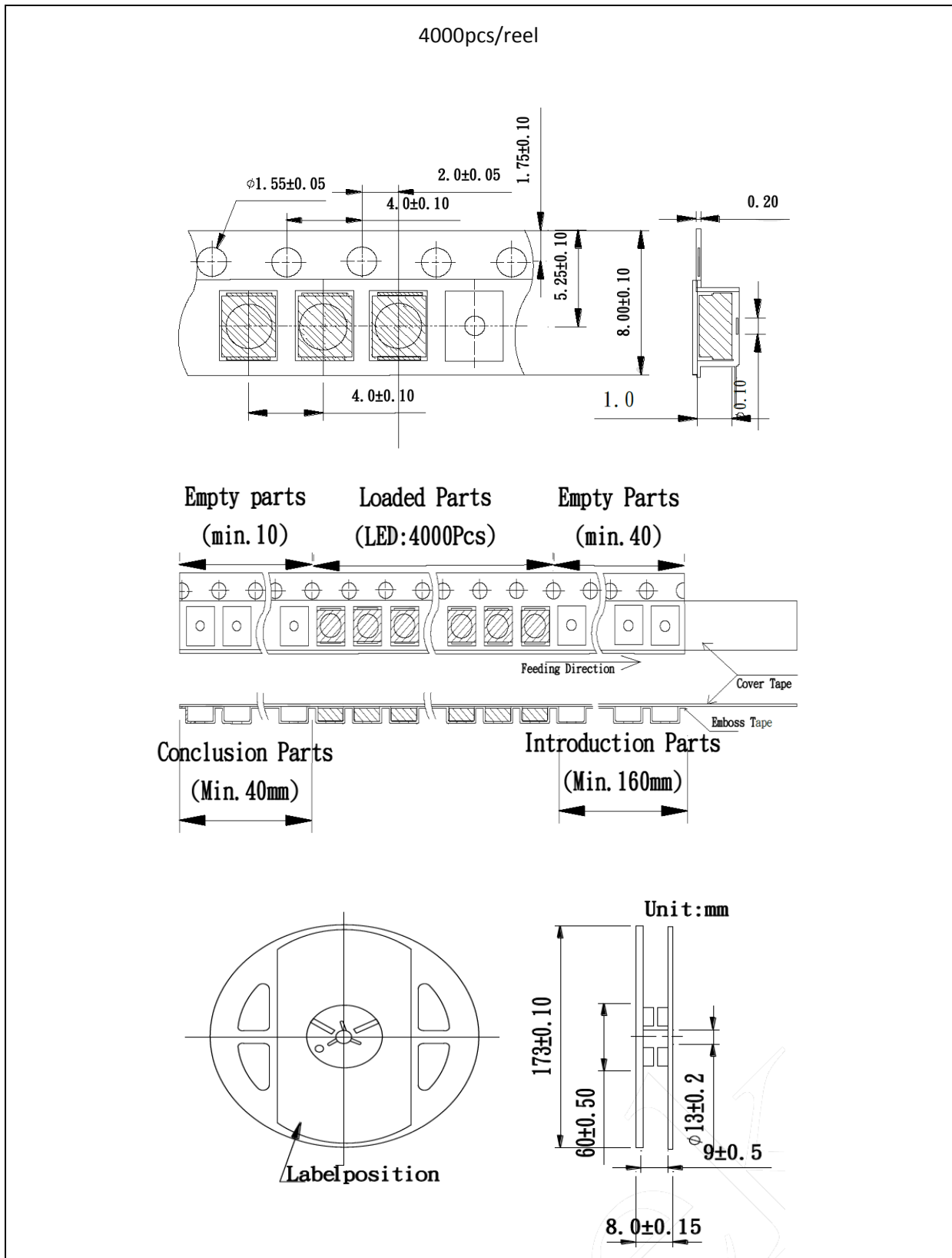

PRECAUTIONS OF USE:

Storage:

It is recommended to store the products in the following conditions:

- Humidity: 60% R.H. Max.
- Temperature: 5°C~30°C (41°F ~86°F).

Shelf life in sealed bag: 12 month at 5°C~30°C and <60% R.H.

Once the package is opened, the products should be used within a week. Otherwise, they should be kept in a damp-proof box with desiccating agent and apply baking at 60°C±5°C for 15hrs before use.

Baking:

It is recommended to bake the LED before soldering if the pack has been unsealed for longer than 24hrs.

The suggested baking conditions are as followings:

- 70±3°C x 24hrs and <5%RH, taped / reel package.
- 100±3°C x 2hrs, bulk (loose) package.
- 130±3°C x 30min, bulk (loose) package.

It's normal to see slight color fading of carrier (light yellow) after baking in process.

Testing Circuit:



Must apply resistor(s) for protection (over current proof).

Cleaning:

Use alcohol-based cleaning solvents such as isopropyl alcohol to clean the LED carrier / package. Avoid putting any stress force directly on to the LED lens.

ESD (Electrostatic Discharge):

Static Electricity or power surge will damage the LED. Use of a conductive wrist band or anti-electrostatic glove is recommended when handling the LED all time. All devices, equipment, machinery, work tables, and storage racks must be properly grounded.

In the events of manual working in process, make sure the devices are well protected from ESD at any time.

REVISION RECORD:

Version	Date	Summary of Revision
A1.0	31/03/2015	Datasheet set-up.