



BRIGHTTEK
BRIGHTTEK (EUROPE) LIMITED

Brighten Up The World With LED!



ISO/TS 16949:2009



BS EN ISO 14001:2004



QC 080000 IECQ HSPM

PRODUCT DATASHEET



- ▶ Ceramic High Power
- ▶ 3535 3.6t Series
- ▶ Red (650~670nm)

NOR56S93



Release Date: 06 July 2021 Version: A1.0

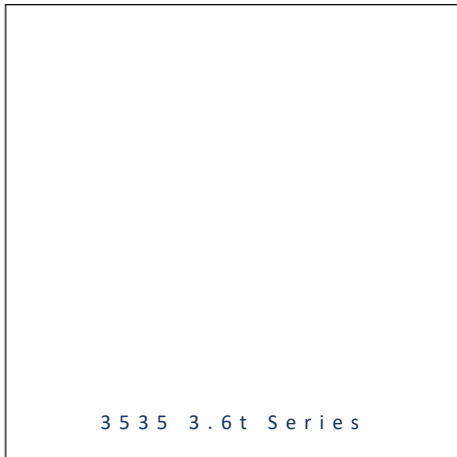

3535 3.6t Series

3535 3.6t Series



RoHS
Compliant

FEATURES:

- **Package:** Ceramic SMT Package with Silicon Lens
- **Forward Current:** 350~700mA
- **Forward Voltage (typ.):** 2.2V
- **Luminous Flux (typ.):** 25lm@350mA
- **Colour:** Deep Red
- **Wavelength:** 650~670nm
- **Viewing angle:** 30°
- **Materials:**
 - Resin: Silicon (Water Clear)
 - L/T Finish: Ag plated
- **Operating Temperature:** -40~+85°C
- **Storage Temperature:** -40~+100°C
- **Grouping parameters:**
 - Forward Voltage
 - Luminous Flux
 - Dominant Wavelength
- **Soldering methods:** Reflow Soldering
- **Preconditioning:** MSL4 according to J-STD020
- **Packing:** 12mm tape with max.500pcs/reel, ø180mm (7")

APPLICATIONS:

- Portable Lighting
- Outdoor Lighting
- Commercial Lighting
- Indoor Lighting
- Industrial Lighting
- Plant Grow Light

CHARACTERISTICS:

Absolute Maximum Characteristics (Ta=25°C)

Parameter	Symbol	Ratings	Unit
DC Forward Current	I_F	700	mA
Pulse Forward Current	I_{PF}	1000	mA
Reverse Voltage	V_R	5	V
Reverse Current @5V	I_R	10	μ A
Junction Temperature	T_j	115	°C
Operating Temperature	T_{OPR}	-40~+85	°C
Storage Temperature	T_{STG}	-40~+100	°C
Soldering Temperature	T_{SOL}	260	°C
Thermal Resistance - Junction to Solder Point	R_{th}	7	°C/W

* in the order of Cool White / Warm White

Electrical & Optical Characteristics (Ta=25°C)

Parameter	Symbol	Values			Unit	Test Condition
		Min.	Typ.	Max.		
Forward Voltage	V_F	1.8	---	2.6	V	$I_F=350mA$
Luminous Flux	Φ_V	15	---	30	lm	$I_F=350mA$
Dominant Wavelength	λ_D	650	---	670	nm	$I_F=350mA$
Viewing Angle	$2\theta_{1/2}$	---	30	---	deg	$I_F=350mA$

1. Radiant Flux (Φ_V) $\pm 5\%$, Forward Voltage (V_F) $\pm 0.06V$, Viewing angle($2\theta_{1/2}$) $\pm 10^\circ$

OUTLINE DIMENSION:

Package Dimension:

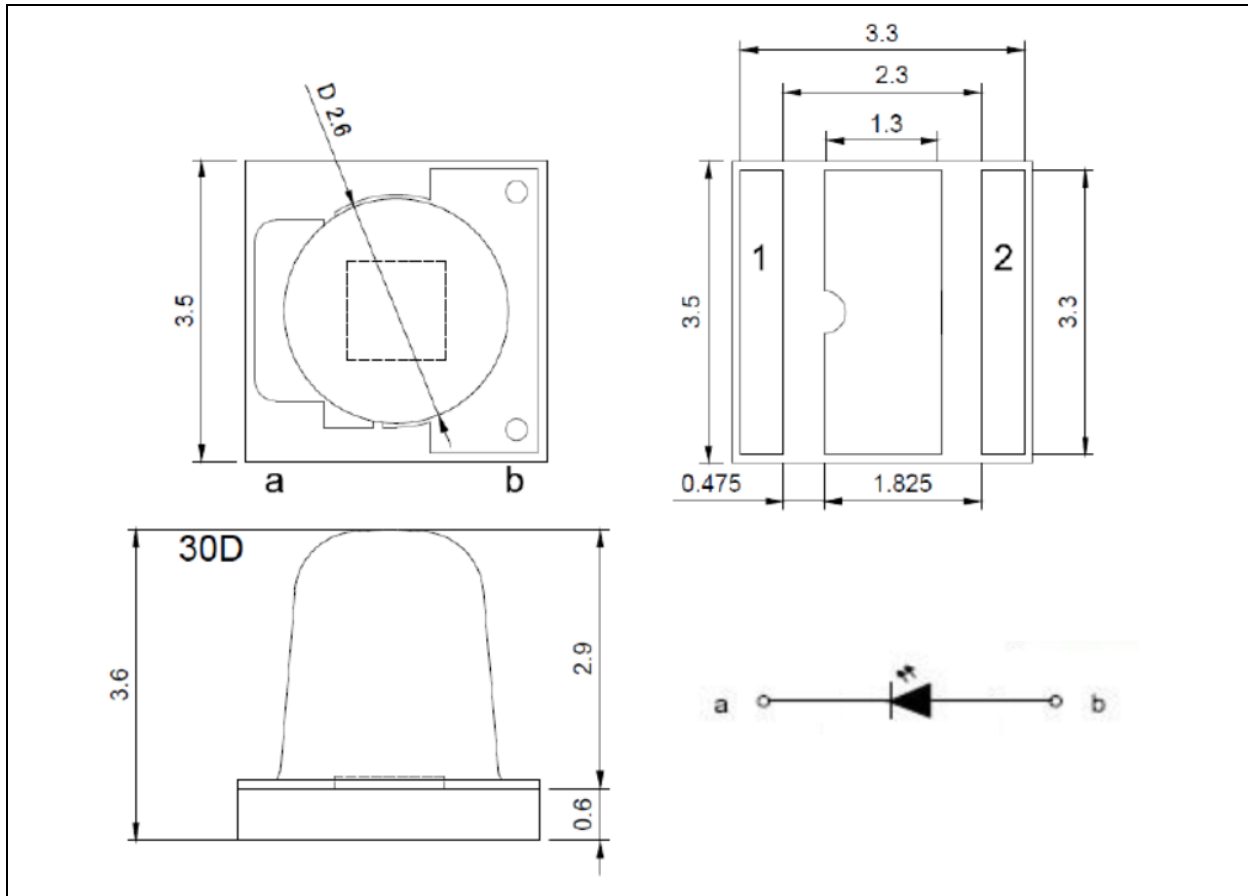

1. All dimensions are in millimetre (mm).
2. Tolerance $\pm 0.13\text{mm}$, unless otherwise noted.

Recommended Soldering Pad Dimension:

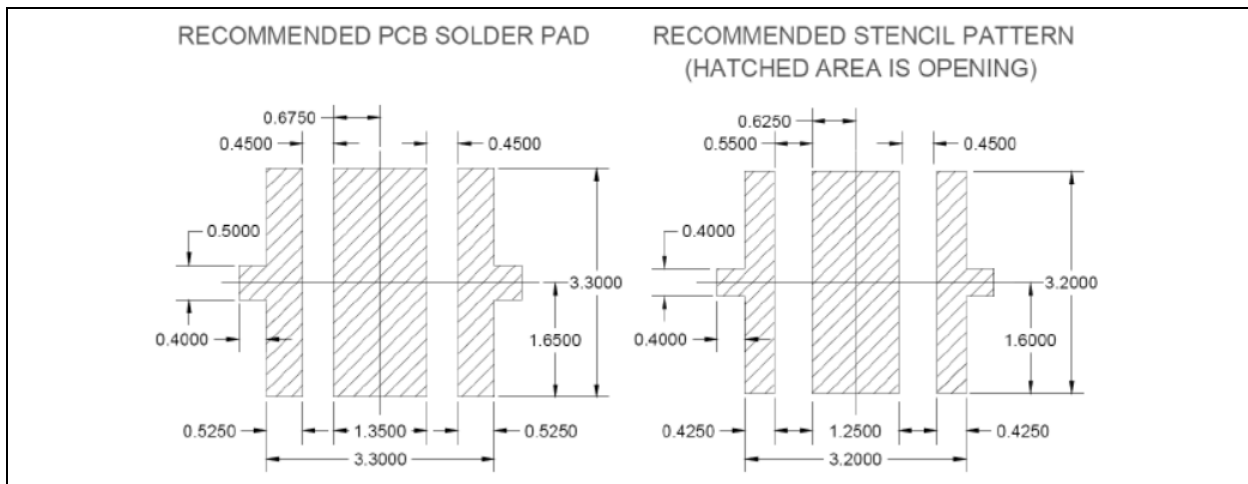

1. Dimensions are in millimetre (mm).
2. Tolerance $\pm 0.12\text{mm}$ with angle tolerance $\pm 0.5^\circ$.

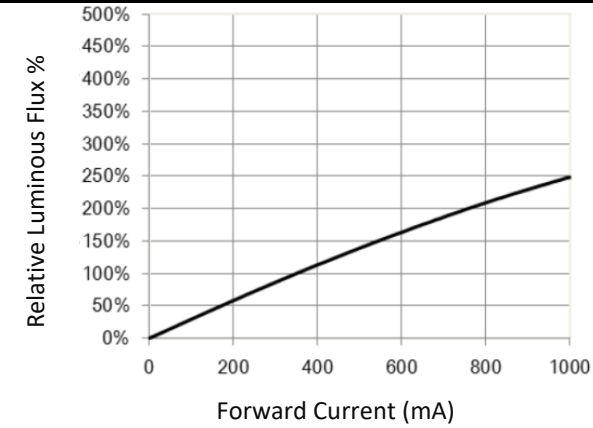
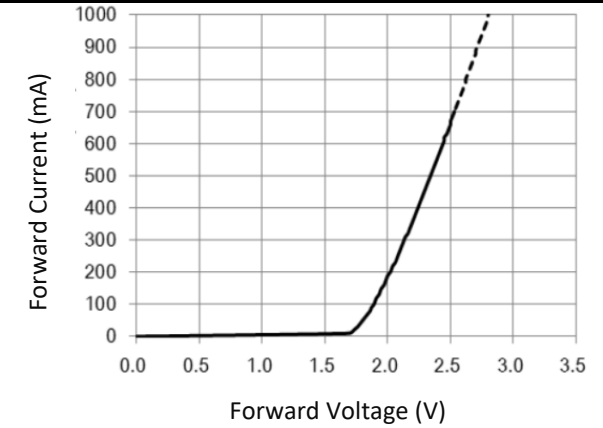
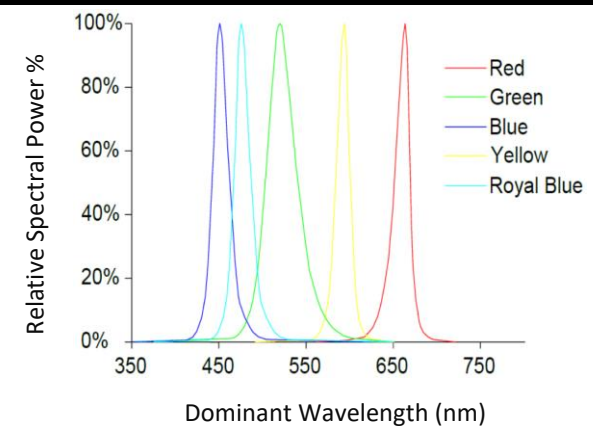
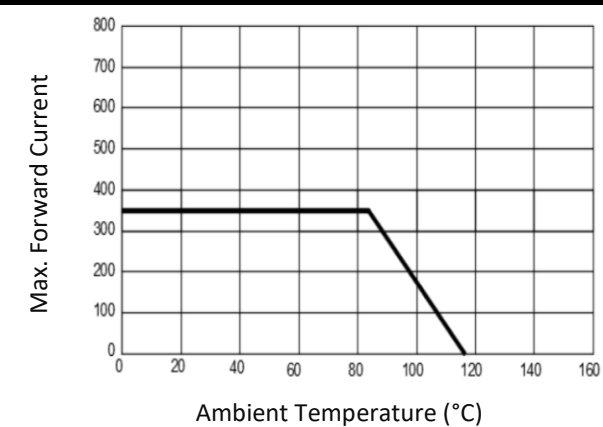
ELECTRO-OPTICAL CHARACTERISTICS:
Relative Luminous Flux v.s. Forward Current

Forward Current v.s. Forward Voltage

Relative Spectral Power v.s. Wavelength

Max. Current v.s. Ambient Temperature

BINNING GROUPS:

 Forward Voltage Classifications ($I_F = 350\text{mA}$):

Code	Min.	Max.	Unit
V18	1.8	2.0	V
V20	2.0	2.2	
V22	2.2	2.4	
V24	2.4	2.6	

 Luminous Flux Classifications ($I_F = 350\text{mA}$):

Code	Min.	Max.	Unit
R15	15	20	lm
R20	20	25	
R25	25	30	

 Dominant Wavelength Classifications ($I_F = 350\text{mA}$):

Code	Min.	Max.	Unit
DR1	650	660	nm
DR2	660	670	

RECOMMENDED SOLDERING PROFILE:

Reflow Lead-free Solder:

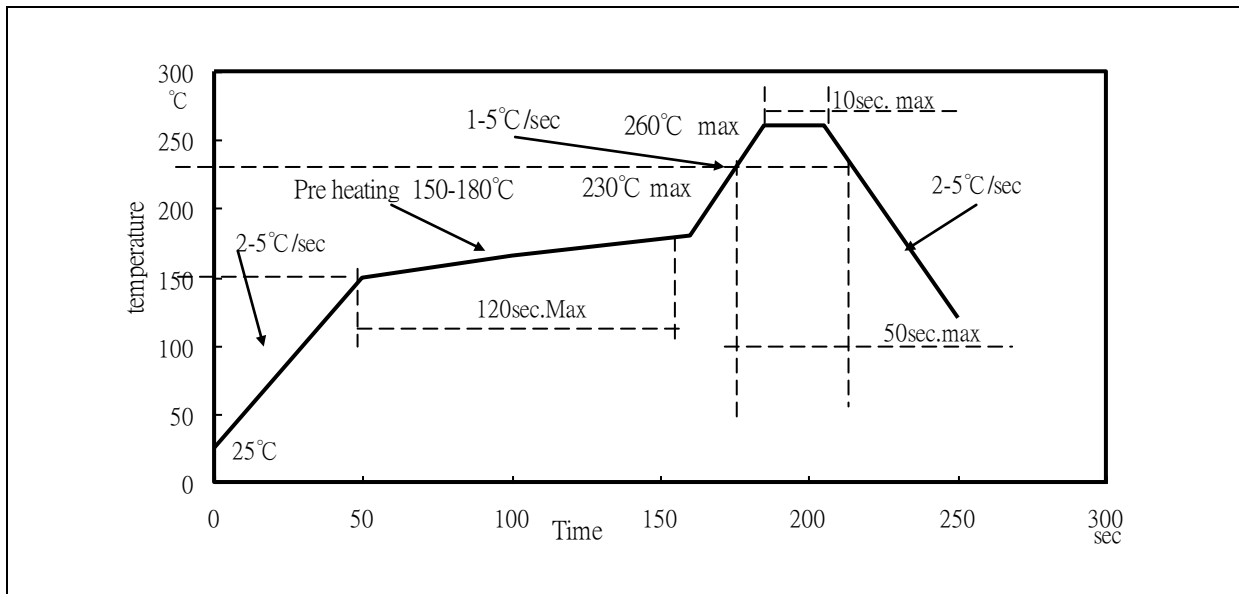

Note:

1. Maxima reflow soldering: 3 times.
2. The recommend reflow temperature is 240°C. The maxima soldering temperature should be limited to 260°C.
3. Before, during, and after soldering, should not apply stress on the components and PCB board.

PACKING SPECIFICATION:

Reel Dimension:

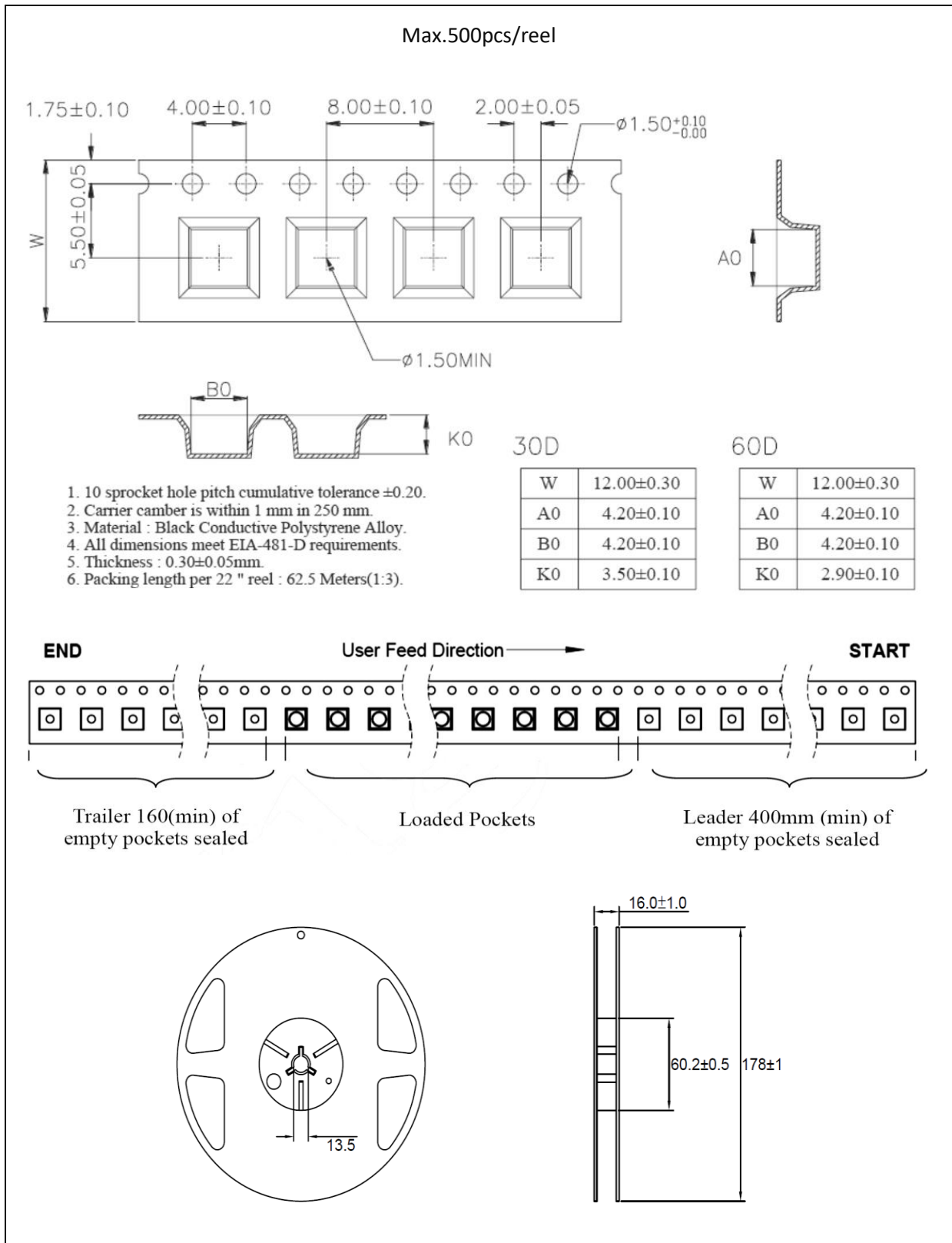

PRECAUTIONS OF USE:

Storage:

It is recommended to store the products in the following conditions:

- Humidity: 60% R.H. Max.
- Temperature: 5°C~30°C (41°F ~86°F).

Shelf life in sealed bag: 12 months at 5°C~30°C and <60% R.H.

Once the package is opened, the products should be used within a week. Otherwise, they should be kept in a damp-proof box with desiccating agent <10% R.H. and apply baking before use.

Baking:

It is recommended to bake the LED before soldering if the pack has been unsealed for longer than 24hrs. The suggested baking conditions are as followings:

- 60±3°C x 24hrs and <5%RH, taped / reel package.

It's normal to see slight color fading of carrier (light yellow) after baking in process.

Testing Circuit:

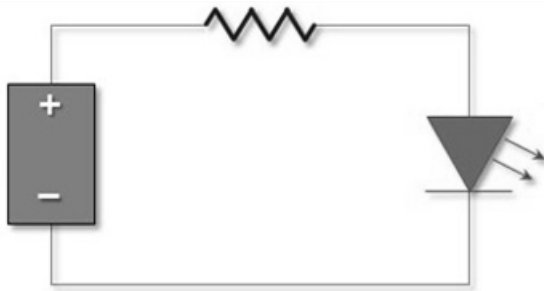

Must apply resistor(s) for protection (over current proof).

Cleaning:

Use alcohol-based cleaning solvents such as isopropyl alcohol to clean the LED carrier / package. Avoid putting any stress force directly on to the LED lens.

ESD (Electrostatic Discharge):

Static Electricity or power surge will damage the LED. Use of a conductive wrist band or anti-electrostatic glove is recommended when handling the LED all time. All devices, equipment, machinery, work tables, and storage racks must be properly grounded.

In the events of manual working in process, make sure the devices are well protected from ESD at any time.

REVISION RECORD:

Version	Date	Summary of Revision
A1.0	06/07/2021	Datasheet set-up.