



BRIGHTTEK
BRIGHTTEK (EUROPE) LIMITED

Brighten Up The World With LED!



ISO/TS 16949:2009



BS EN ISO 14001:2004



QC 080000 IECQ HSPM

PRODUCT DATASHEET



- ▶ SuperFlux (Piranha)
- ▶ Flat 2.5t
- ▶ Red (625nm)

NOR27P46S



Release Date: 27 June 2022 Version: A1.1

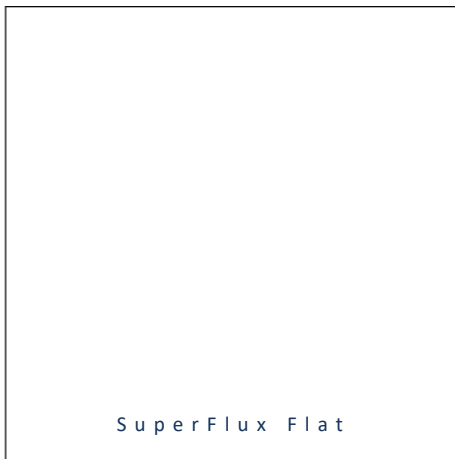

SuperFlux Flat

SuperFlux Flat

RoHS
Compliant



FEATURES:

- **Package:** PTH Through Hole 4-Pins Package
- **Forward Current:** 20mA
- **Forward Voltage (typ.):** 2.1V
- **Luminous Intensity (typ.):** 350mcd@20mA
- **Colour:** Red
- **Wavelength:** 625nm
- **Viewing angle:** 130°
- **Materials:**
 - Die: AlGaInP
 - Resin: Epoxy (Water Clear)
 - L/T Finish: Ag plated
- **Operating Temperature:** -40~+85°C
- **Storage Temperature:** -40~+100°C
- **ESD (HBM):** 2000V
- **Grouping parameters:**
 - Forward voltage
 - Luminous intensity
 - Dominant Wavelength
- **Soldering methods:** Wave Soldering
- **MSL:** acc. to JEDEC Level 3
- **Packing:** 60pcs/tube; 6300pcs/carton

APPLICATIONS:

- Indicator
- Signal Light
- Decorative Light

CHARACTERISTICS:

Absolute Maximum Characteristics (Ta=25°C)

Parameter	Symbol	Ratings	Unit
Forward Current	I _F	50	mA
Pulse Forward Current Duty 1/10 at 10KHz	I _{PF}	90	mA
Power Dissipation	PD	120	mW
Reverse Current @5V	I _R	10	μA
Electrostatics Discharge (HBM)	ESD	2000	V
Operating Temperature	T _{OPR}	-40~+85	°C
Storage Temperature	T _{STG}	-40~+100	°C

Electrical & Optical Characteristics (Ta=25°C)

Parameter	Symbol	Values			Unit	Test Condition
		Min.	Typ.	Max.		
Forward Voltage	V _F	1.7	---	2.6	V	I _F =20mA
Luminous Intensity	I _v	220	350	---	mcd	I _F =20mA
Dominant Wavelength	λ _D	---	625	---	nm	I _F =20mA
Spectral Half Width	Δλ	---	20	---	nm	I _F =20mA
Viewing Angle	2θ _{1/2}	---	130	---	deg	I _F =20mA

- Luminous intensity (I_v) ±15%, Forward Voltage (V_F) ±0.1V, Viewing angle(2θ_{1/2}) ±5%

OUTLINE DIMENSION:

Package Dimension:

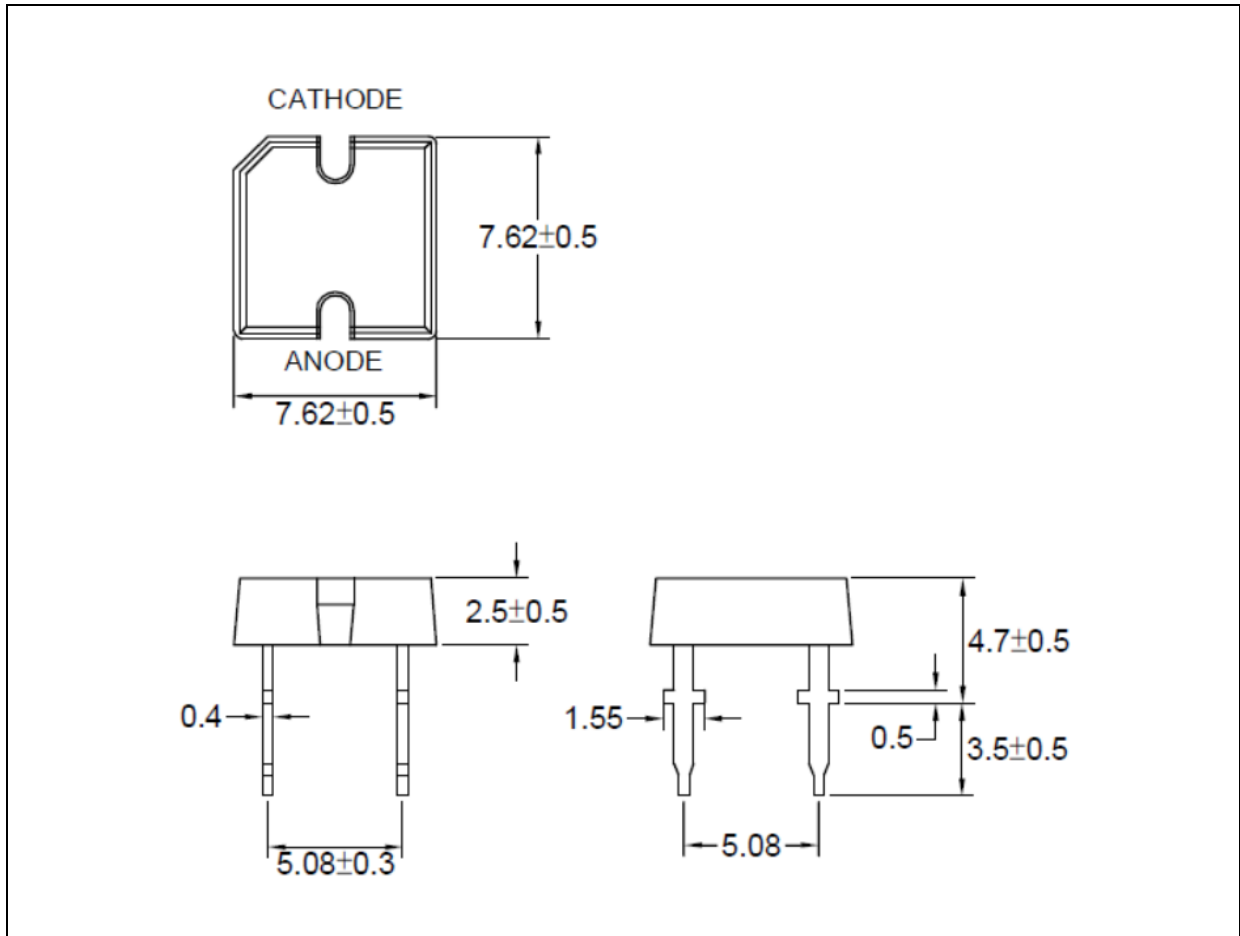

1. All dimensions are in millimetre (mm).
2. Tolerance ± 0.2 mm, unless otherwise noted.

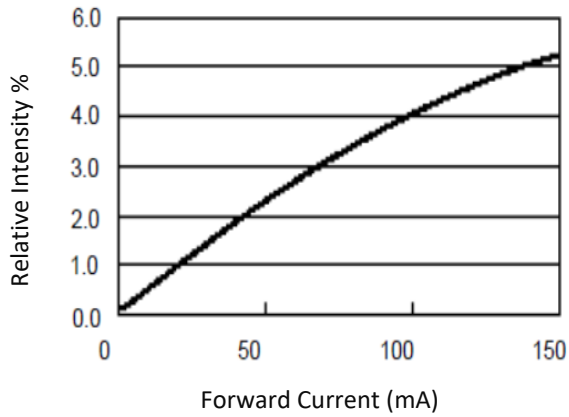
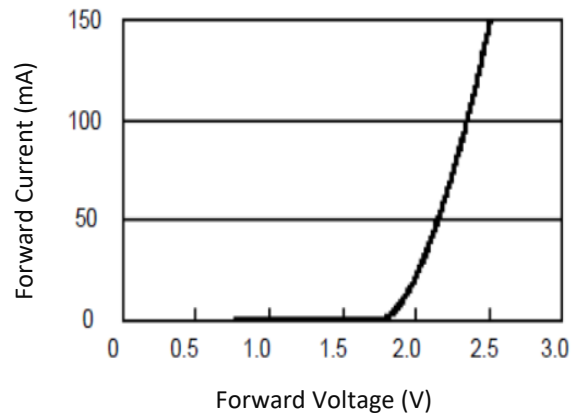
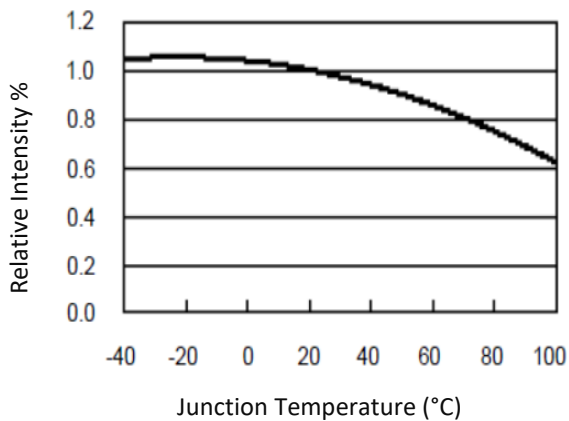
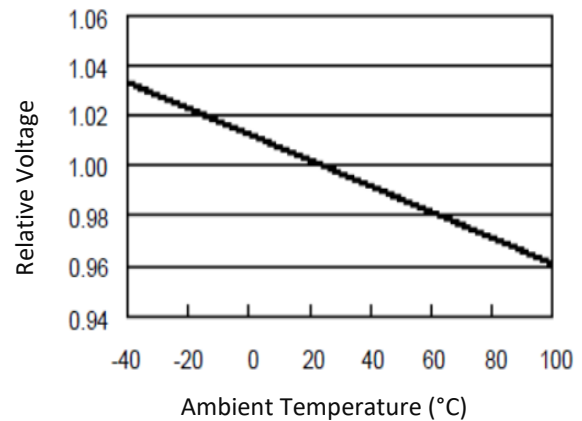
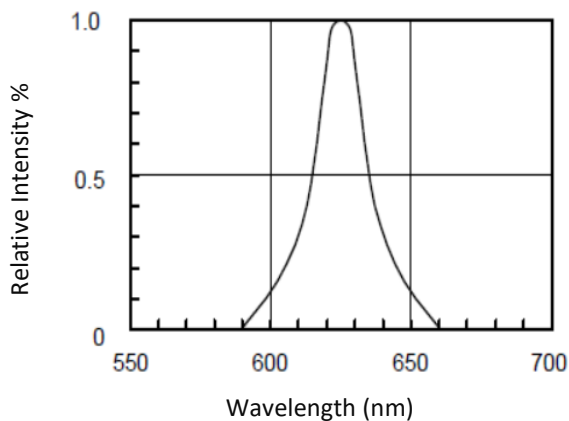
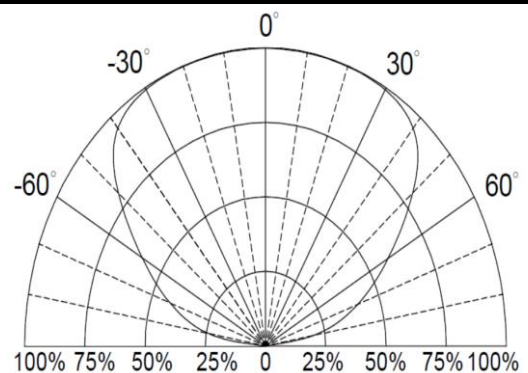
ELECTRO-OPTICAL CHARACTERISTICS:
Relative Intensity v.s. Forward Current

Forward Current v.s. Forward Voltage

Relative Intensity v.s. Temperature

Relative Voltage v.s. Temperature

Relative Intensity v.s. Wavelength

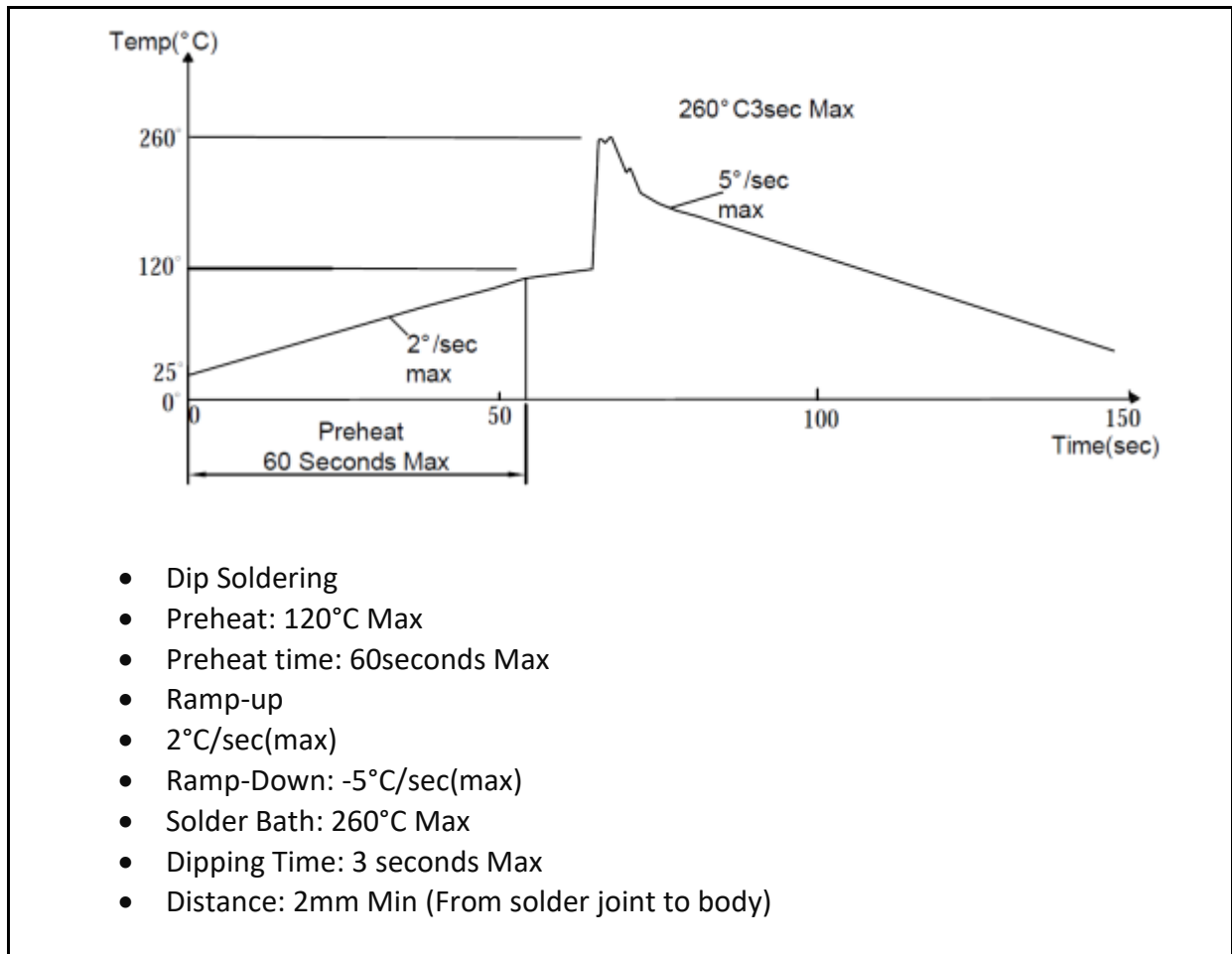
Directive Radiation

RECOMMENDED SOLDERING PROFILE:

DIP Iron:

- Soldering Iron 30W Max.
- Temperature 350°C Max.
- Soldering Time 3 seconds Max. One time only.
- Distance 2mm Min. (from solder joint to body).

Wave Soldering Profile:



- Dip Soldering
- Preheat: 120°C Max
- Preheat time: 60seconds Max
- Ramp-up
- 2°C/sec(max)
- Ramp-Down: -5°C/sec(max)
- Solder Bath: 260°C Max
- Dipping Time: 3 seconds Max
- Distance: 2mm Min (From solder joint to body)

Note:

1. Maximum reflow soldering: 1 time.
2. Before, during, and after soldering, should not apply stress on the components and PCB board.
3. Recommended reflow temperature 240°C. The maximum soldering temperature should be limited to 260°C.

PACKING SPECIFICATION:

Tube Dimension:

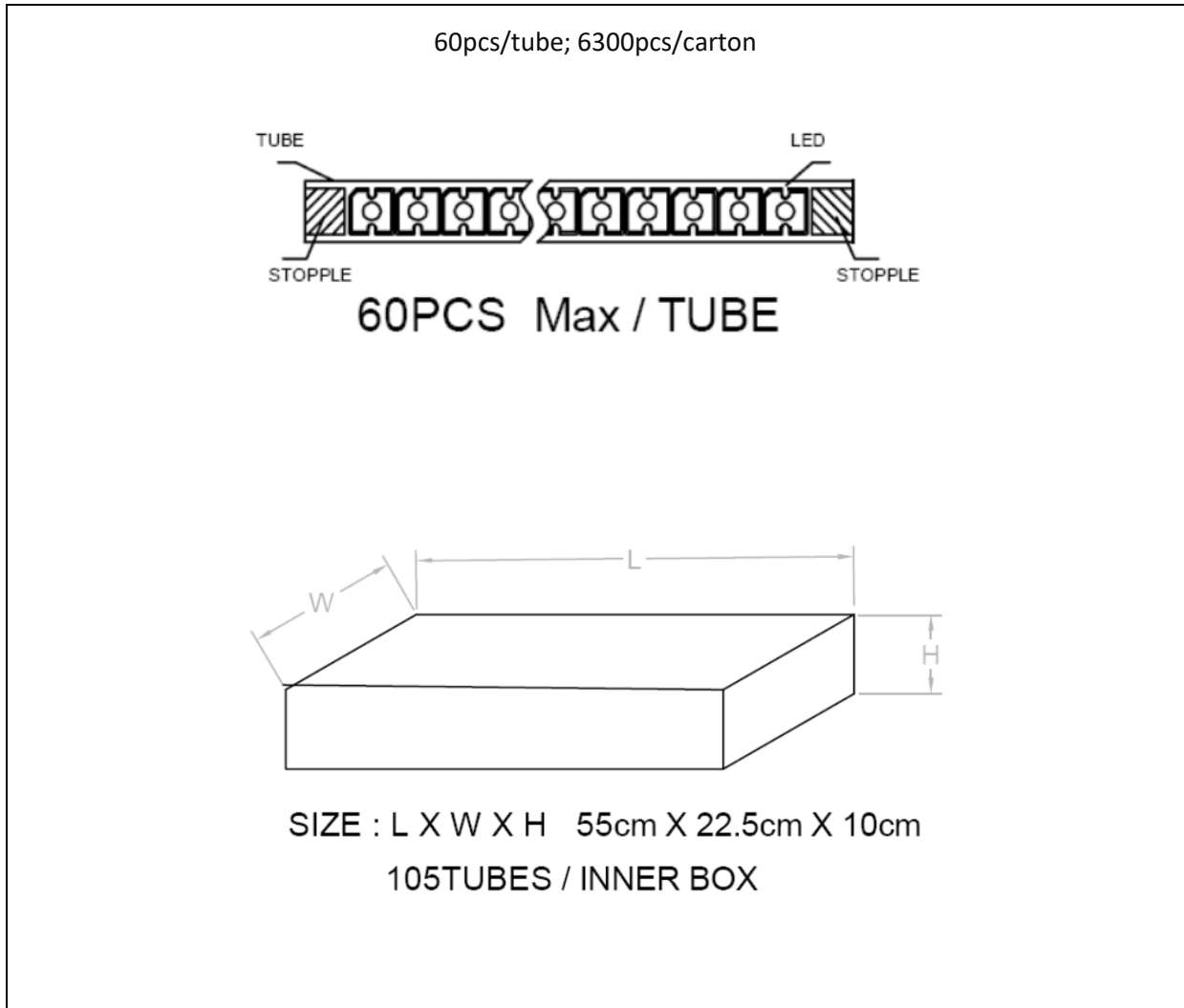

PRECAUTIONS OF USE:

Storage:

It is recommended to store the products in the following conditions:

- Humidity: 60% R.H. Max.
- Temperature: 5°C~30°C (41°F ~86°F).

Shelf life in sealed bag: 12 months at 5°C~30°C and <60% R.H.

Once the package is opened, the products should be used within a week. Otherwise, they should be kept in a damp-proof box with desiccating agent <10% R.H. and apply baking before use.

Baking:

It is recommended to bake the LED before soldering if the pack has been unsealed for longer than 24hrs. The suggested baking conditions are as followings:

- 60±3°C x 6hrs and <5%RH, for reel package.

It's normal to see slight color fading of carrier (light yellow) after baking in process.

Testing Circuit:

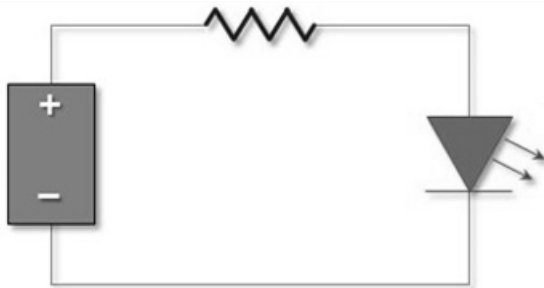

Must apply resistor(s) for protection (over current proof).

Cleaning:

Use alcohol-based cleaning solvents such as isopropyl alcohol to clean the LED carrier / package. Avoid putting any stress force directly on to the LED lens.

ESD (Electrostatic Discharge):

Static Electricity or power surge will damage the LED. Use of a conductive wrist band or anti-electrosatic glove is recommended when handling the LED all time. All devices, equipment, machinery, work tables, and storage racks must be properly grounded.

In the events of manual working in process, make sure the devices are well protected from ESD at any time.

REVISION RECORD:

Version	Date	Summary of Revision
A1.0	02/11/2006	Datasheet set-up.
A1.1	27/06/2022	Add -S ending.