



**BRIGHTTEK**  
**BRIGHTTEK (EUROPE) LIMITED**

*Brighten Up The World With LED!*



ISO/TS 16949:2009



BS EN ISO 14001:2004



QC 080000 IECQ HSPM

## PRODUCT DATASHEET



- ▶ PCB Side View
- ▶ 1204SV Series (1.4t)
- ▶ Red (630nm)

# NOR11S77SV



Release Date: 09 September 2016 Version: A1.1



## 1204SV 1.4t Series

**RoHS**  
Compliant



### FEATURES:

- **Package:** Side View PCB / CHIP LED
- **Forward Current:** 20mA
- **Forward Voltage (typ.):** 2.0V
- **Luminous Intensity (typ.):** 85mcd @20mA
- **Colour:** Red
- **Wavelength:** 630nm
- **Viewing angle:** 150°
- **Materials:**
  - Die: AlGaInP/GaAs
  - Resin: Epoxy (Water Clear)
- **Operating Temperature:** -40~+80°C
- **Storage Temperature:** -40~+85°C
- **Grouping parameters:**
  - Forward voltage
  - Luminous intensity
  - Dominant wavelength
- **Soldering methods:** Reflow
- **Preconditioning:** acc. to JEDEC Level 3
- **Packing:** 8mm tape with 3000/reel, ø180mm (7")

### APPLICATIONS:

- Backlighting
- Indication Light
- Switch light
- Dashboard

## CHARACTERISTICS:

### Absolute Maximum Characteristics (Ta=25°C)

Parameter	Symbol	Ratings	Unit
Forward Current	$I_F$	30	mA
Peak Forward Current Duty 1/8@1KHz	$I_{FP}$	125	mA
Reverse Current @5V	$I_R$	10	$\mu$ A
Power Dissipation	$P_D$	75	mW
Operating Temperature	$T_{OPR}$	-40~+80	°C
Storage Temperature	$T_{STG}$	-40~+85	°C

### Electrical & Optical Characteristics (Ta=25°C)

Parameter	Symbol	Values			Unit	Test Condition
		Min.	Typ.	Max.		
Forward Voltage	$V_F$	1.7	2.0	2.5	V	$I_F=20mA$
Luminous Intensity	$I_V$	50	85	160	mcd	$I_F=20mA$
Dominant Wavelength	$\lambda_D$	625	630	635	nm	$I_F=20mA$
Peak Wavelength	$\lambda_P$	---	640	---	nm	$I_F=20mA$
Spectral Line Half Bandwidth	$\Delta \lambda$	---	18	---	nm	$I_F=20mA$
Viewing Angle	$2\theta_{1/2}$	---	150	---	deg	$I_F=20mA$

1. Luminous intensity ( $I_V$ )  $\pm 15\%$ , Forward Voltage ( $V_F$ )  $\pm 0.1V$ , Viewing angle( $2\theta_{1/2}$ )  $\pm 5\%$
2. IS standard testing

## OUTLINE DIMENSION:

### Package Dimension:

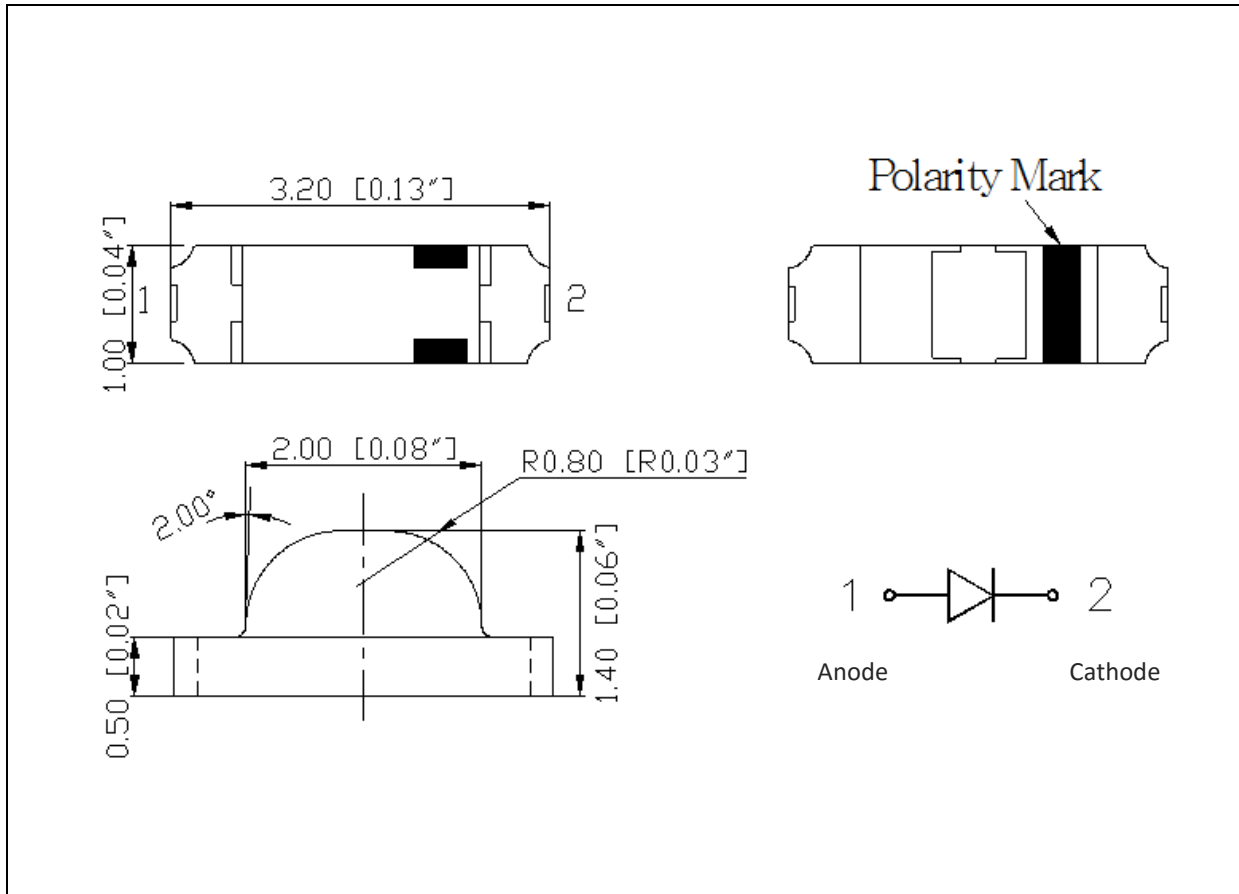

1. All dimensions are in millimetre (mm).
2. Tolerance  $\pm 0.2\text{mm}$ , unless otherwise noted.

### Recommended Soldering Pad Dimension:

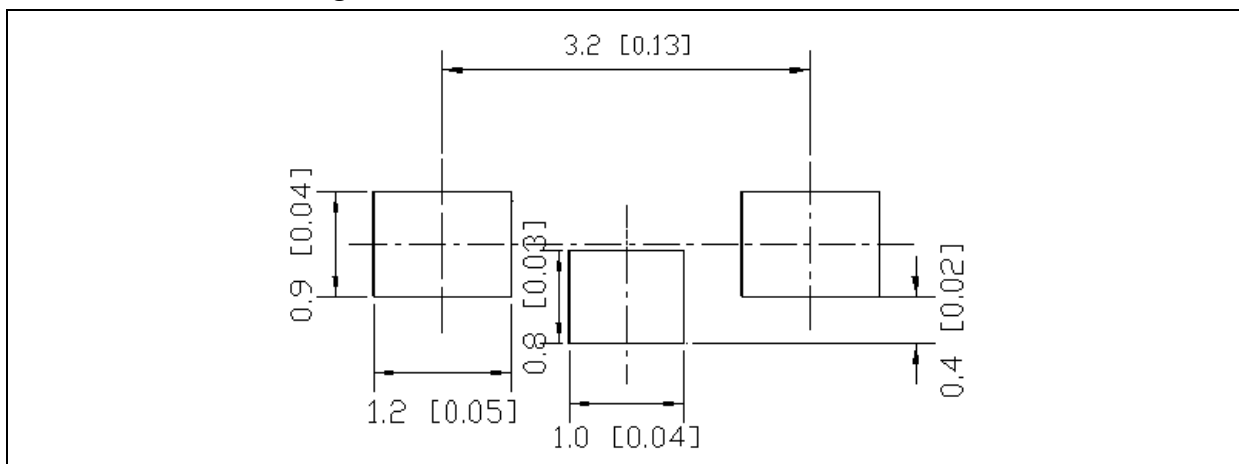

1. Dimensions are in millimetre (mm).
2. Tolerance  $\pm 0.1\text{mm}$  with angle tolerance  $\pm 0.5^\circ$ .

**BINNING GROUPS:**

---

 Forward Voltage Classifications ( $I_F = 20\text{mA}$ ):

Code	Min.	Max.	Unit
B	1.7	2.5	V

 Luminous Intensity Classifications ( $I_F = 20\text{mA}$ ):

Code	Min.	Max.	Unit
G	50	63	mcd
H	63	80	
I	80	100	
J	100	125	
K	125	160	

 Dominant Wavelength Classifications ( $I_F = 20\text{mA}$ ):

Code	Min.	Max.	Unit
U	625	630	nm
V	630	635	

**ELECTRO-OPTICAL CHARACTERISTICS:**

Relative Spectral Distribution

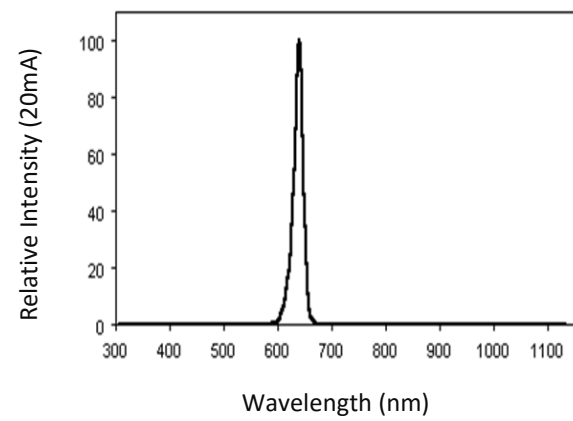

Forward Current v.s. Forward Voltage

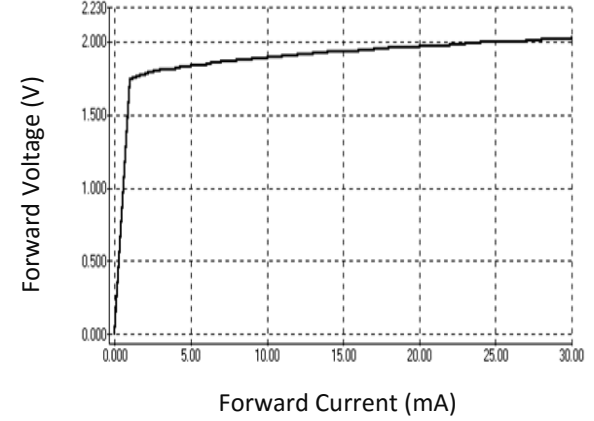

Directive Radiation

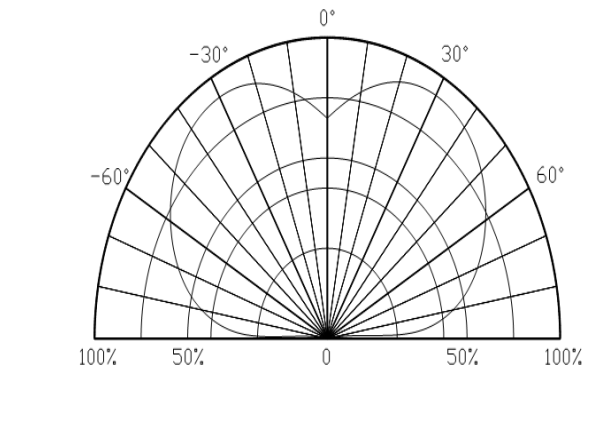

## RECOMMENDED SOLDERING PROFILE:

Reflow Solder:

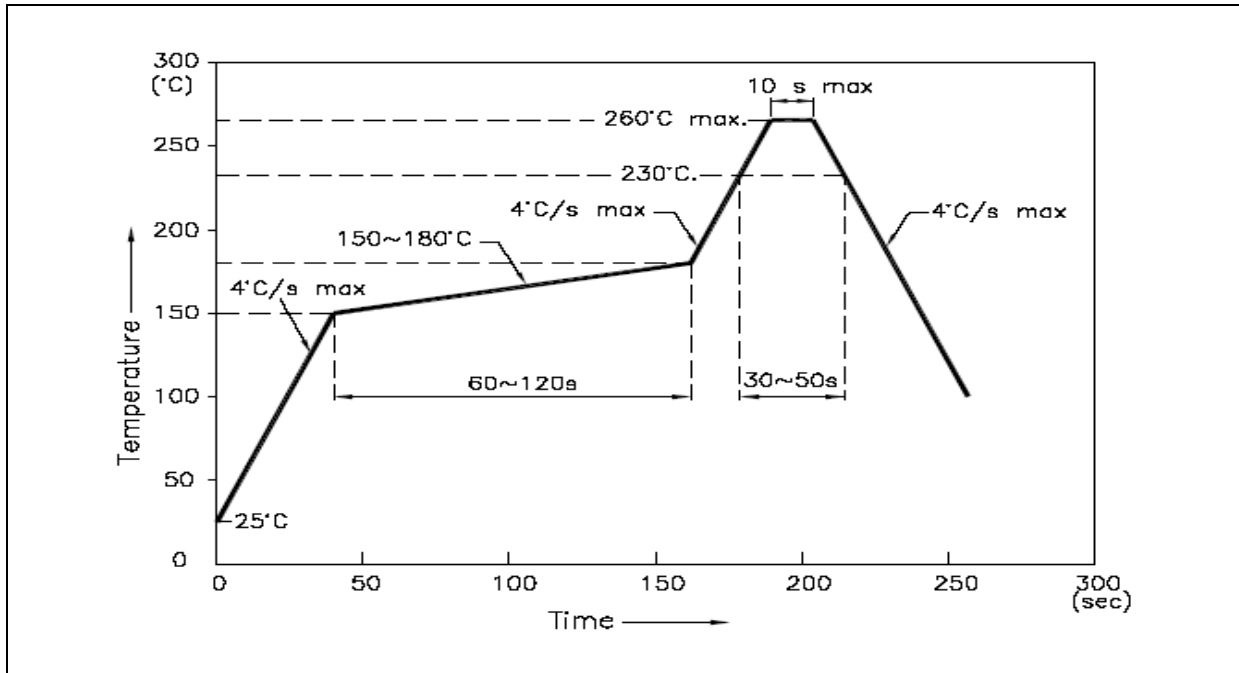

Note:

1. Recommend reflow temperature 245°C.
2. Maximum reflow soldering: 2 times.
3. Before, during, and after soldering, should not apply stress on the components and PCB board.

## PACKING SPECIFICATION:

Reel Dimension:

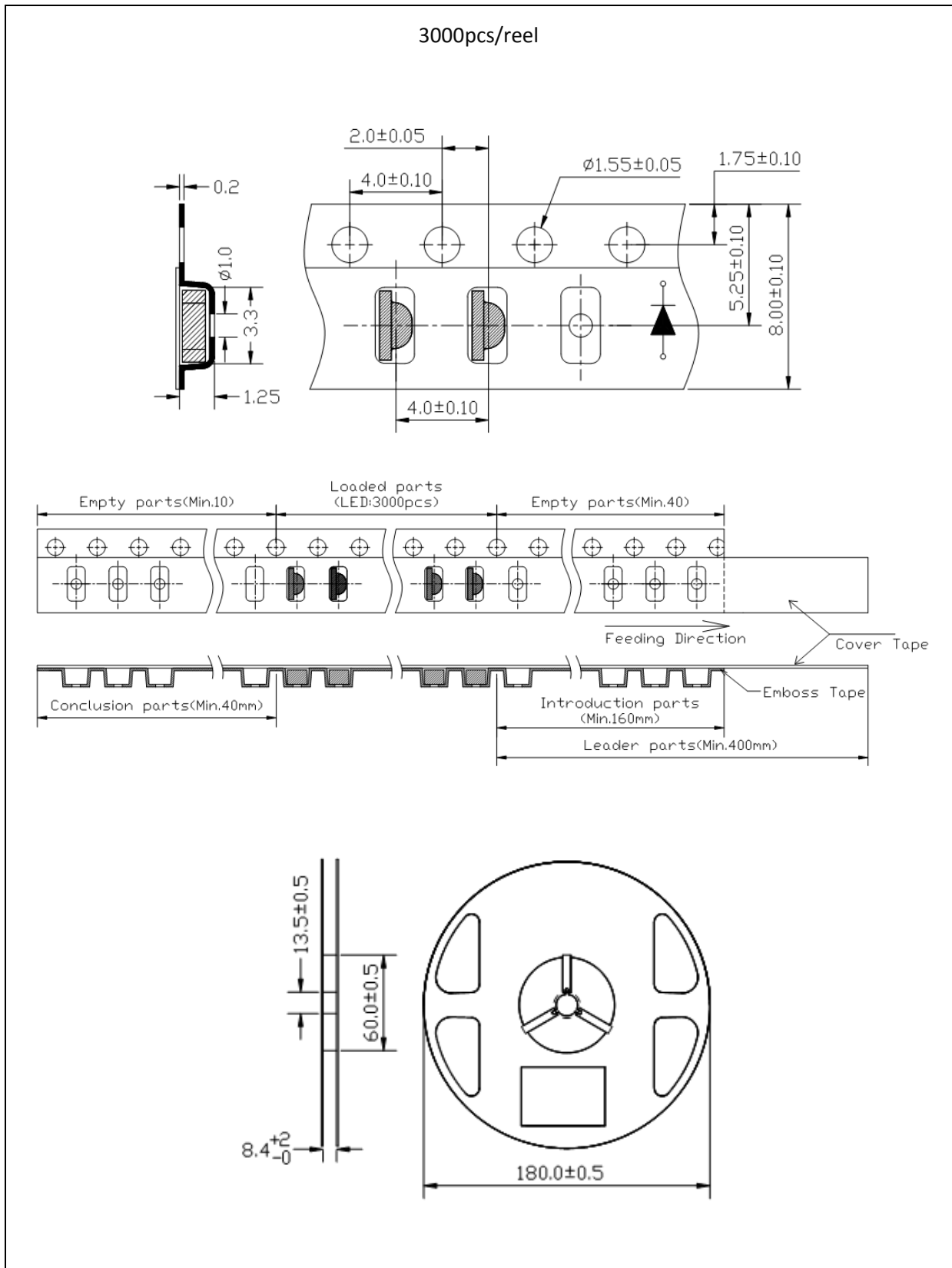

## PRECAUTIONS OF USE:

---

### Storage:

It is recommended to store the products in the following conditions:

- Humidity: 60% R.H. Max.
- Temperature: 5°C~30°C (41°F ~86°F).

Shelf life in sealed bag: 12 month at 5°C~30°C and <60% R.H.

Once the package is opened, the products should be used within a week. Otherwise, they should be kept in a damp-proof box with desiccating agent and apply baking at 60°C±5°C for 15hrs before use.

### Baking:

It is recommended to bake the LED before soldering if the pack has been unsealed for longer than 24hrs.

The suggested baking conditions are as follows:

- 70±3°C x 24hrs and <5%RH, taped / reel package.
- 100±3°C x 2hrs, bulk (loose) package.
- 130±3°C x 30min, bulk (loose) package.

It's normal to see slight color fading of carrier (light yellow) after baking in process.

### Testing Circuit:



Must apply resistor(s) for protection (over current proof).

### Cleaning:

Use alcohol-based cleaning solvents such as isopropyl alcohol to clean the LED carrier / package. Avoid putting any stress force directly on to the LED lens.

### ESD (Electrostatic Discharge):

Static Electricity or power surge will damage the LED. Use of a conductive wrist band or anti-electrostatic glove is recommended when handling the LED all time. All devices, equipment, machinery, work tables, and storage racks must be properly grounded.

In the events of manual working in process, make sure the devices are well protected from ESD at any time.



**REVISION RECORD:**

---

Version	Date	Summary of Revision
A1.0	07/08/2014	Datasheet set-up.
A1.1	09/09/2016	Part number adds -SV to indicate side view.