



**BRIGHTTEK**  
**BRIGHTTEK (EUROPE) LIMITED**

*Brighten Up The World With LED!*



ISO/TS 16949:2009



BS EN ISO 14001:2004



QC 080000 IECQ HSPM

## PRODUCT DATASHEET



- ▶ PLCC2 Side View
- ▶ 0.8t (2.8x1.2x0.8mm)
- ▶ Red (624-636nm)

NOR02S68SV



Release Date: 06 November 2015 Version: A1.2

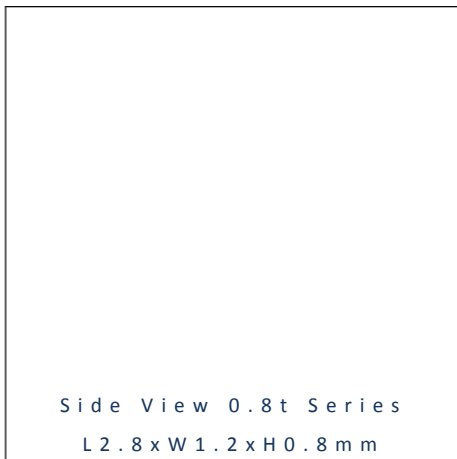

### 2812SV Series



#### FEATURES:

- **Package:** Side View PLCC White SMT Package
- **Forward Current:** 20mA
- **Forward Voltage (typ.):** 2.0V
- **Luminous Intensity (typ.):** 80mcd @20mA
- **Colour:** Red
- **Wavelength:** 624-636nm
- **Viewing angle:** 115°
- **Materials:**
  - Die: AlGaInP
  - Resin: Epoxy (Water Clear)
- **Operating Temperature:** -40~+85°C
- **Storage Temperature:** -40~+100°C
- **ESD:** 2000V
- **Grouping parameters:**
  - Forward voltage
  - Luminous intensity
  - Dominant Wavelength
- **Soldering methods:** Reflow
- **Preconditioning:** acc. to JEDEC Level 3
- **Packing:** 8mm tape with 3000/reel, ø180mm (7")

#### APPLICATIONS:

- Backlighting
- Indication Light
- Side view light strip
- Switch light

**CHARACTERISTICS:**

---

## Absolute Maximum Characteristics (Ta=25°C)

Parameter	Symbol	Ratings	Unit
Forward Current	$I_F$	30	mA
Peak Forward Current Duty 1/10@10KHz	$I_{FP}$	90	mA
Reverse Current @5V	$I_R$	10	$\mu$ A
Power Dissipation	PD	72	mW
Electrostatic Discharge	ESD	2000	V
Operating Temperature	$T_{OPR}$	-40~+85	°C
Storage Temperature	$T_{STG}$	-40~+100	°C

## Electrical &amp; Optical Characteristics (Ta=25°C)

Parameter	Symbol	Values			Unit	Test Condition
		Min.	Typ.	Max.		
Forward Voltage	$V_F$	1.5	---	2.4	V	$I_F=20mA$
Luminous Intensity	$I_V$	32	80	---	mcd	$I_F=20mA$
Dominant Wavelength	$\lambda_D$	624	630	636	nm	$I_F=20mA$
Spectral Line Half Bandwidth	$\Delta \lambda$	---	20	---	nm	$I_F=20mA$
Viewing Angle	$2\theta_{1/2}$	---	115	---	deg	$I_F=20mA$

- Luminous intensity ( $I_V$ )  $\pm 15\%$ , Forward Voltage ( $V_F$ )  $\pm 0.1V$

## OUTLINE DIMENSION:

Package Dimension:

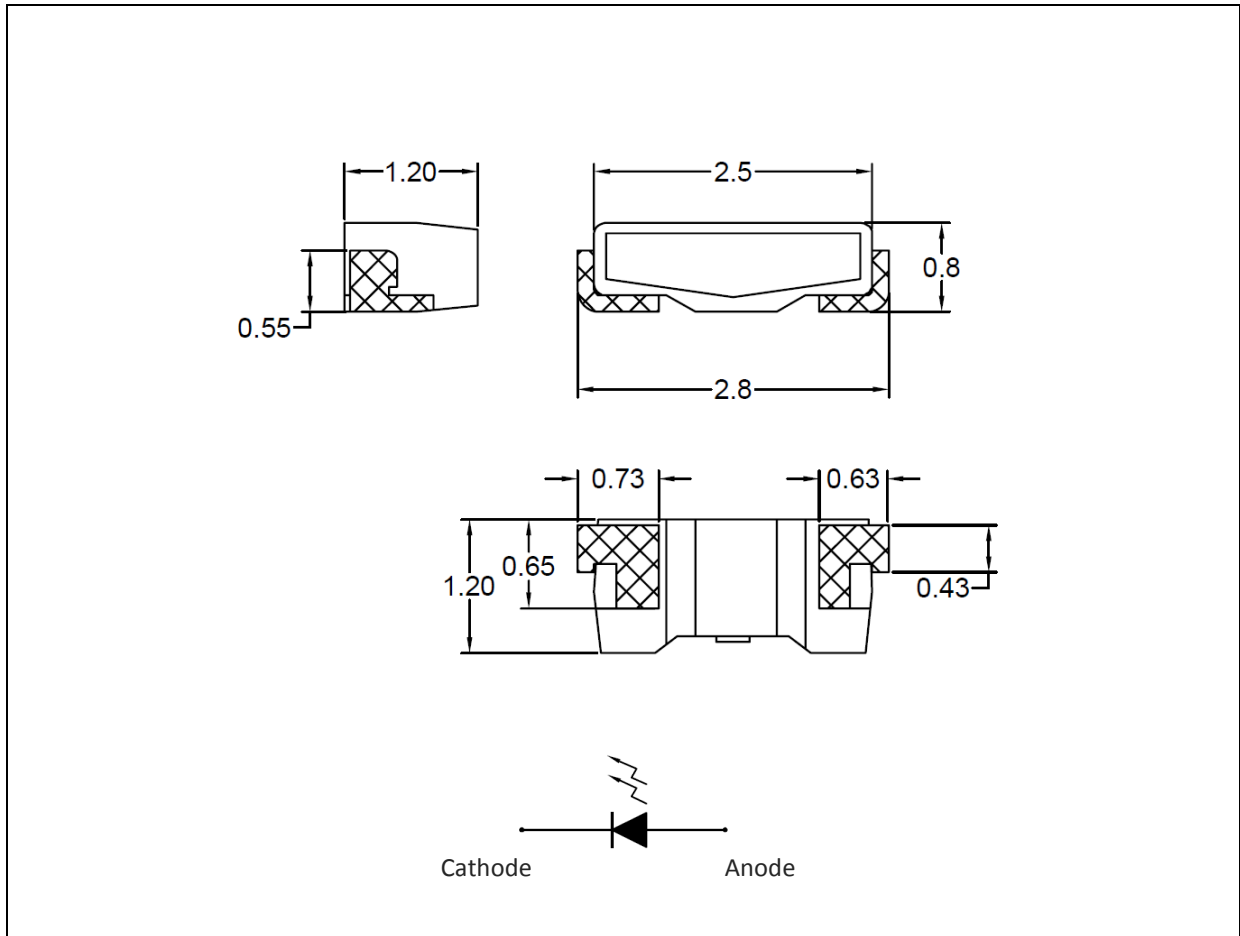

1. All dimensions are in millimetre (mm).
2. Tolerance  $\pm 0.1\text{mm}$ , unless otherwise noted.

Recommended Soldering Pad Dimension:

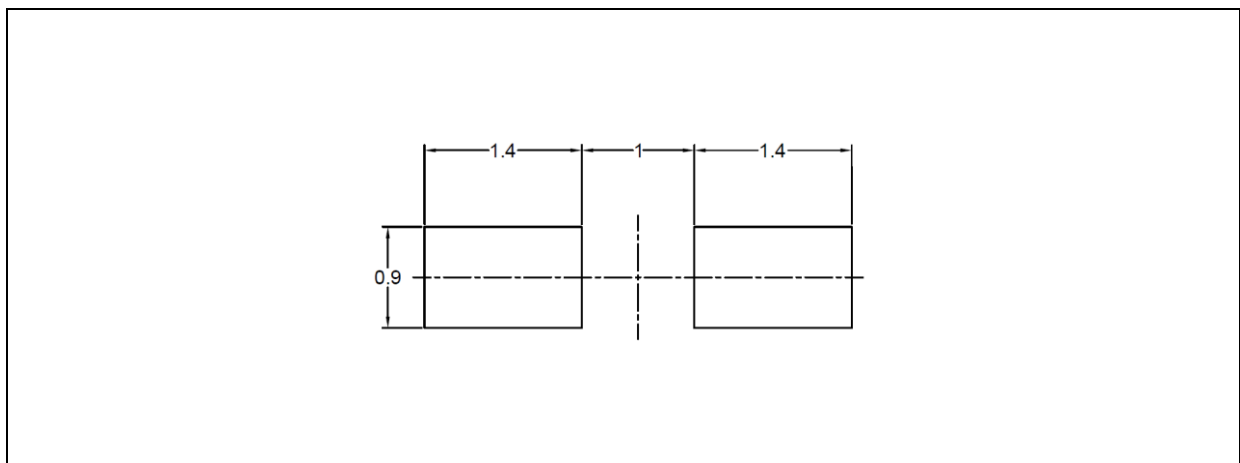

1. Dimensions are in millimetre (mm).
2. Tolerance  $\pm 0.1\text{mm}$  with angle tolerance  $\pm 0.5^\circ$ .

**BINNING GROUPS:**

---

 Forward Voltage Classifications ( $I_F = 20\text{mA}$ ):

Code	Min.	Max.	Unit
1	1.4	1.6	V
2	1.6	1.8	
3	1.8	2.0	
4	2.0	2.2	
5	2.2	2.4	

 Luminous Intensity Classifications ( $I_F = 20\text{mA}$ ):

Code	Min.	Max.	Unit
N	32	50	mcd
P	50	80	
Q	80	125	
W	125	200	

 Dominant Wavelength Classifications ( $I_F = 20\text{mA}$ ):

Code	Min.	Max.	Unit
29	624	627	nm
30	627	630	
31	630	633	
32	633	636	

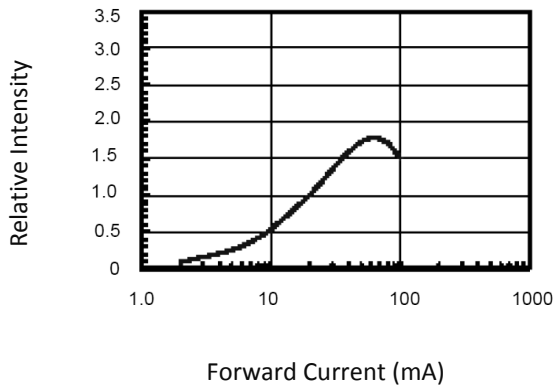
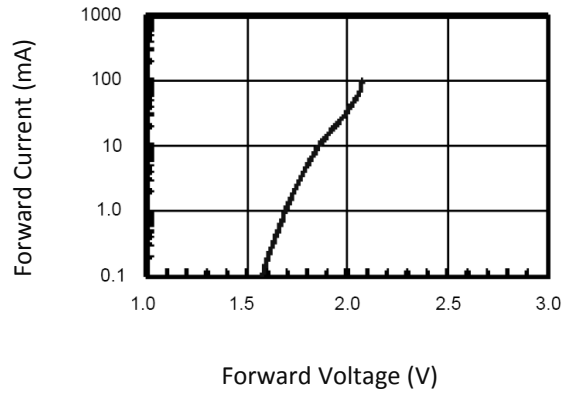
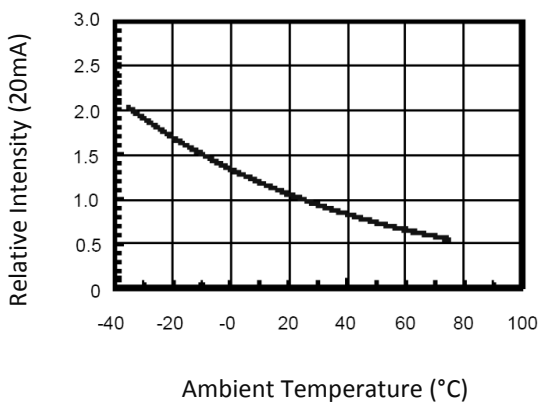
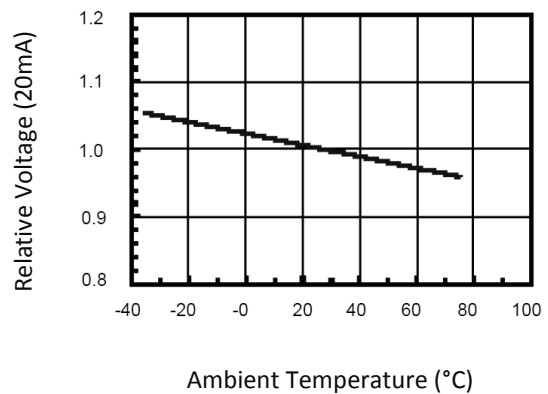
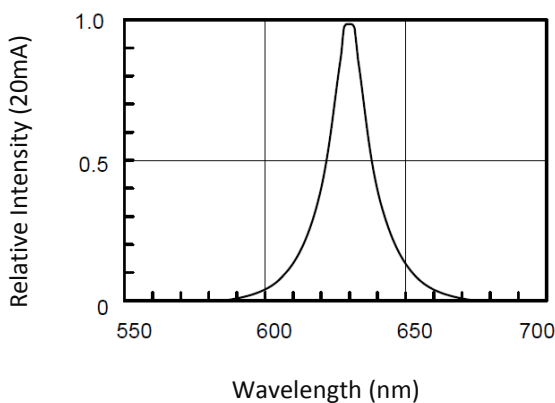
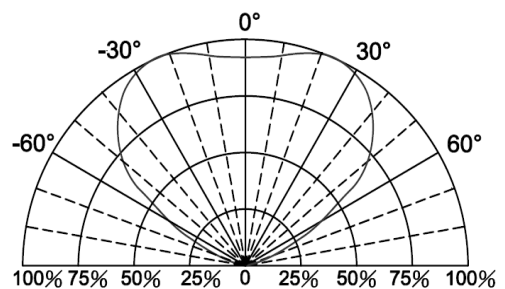
**ELECTRO-OPTICAL CHARACTERISTICS:**
**Relative Intensity v.s. Forward Current**

**Forward Current v.s. Forward Voltage**

**Relative Intensity v.s. Temperature**

**Relative Forward Voltage v.s. Temperature**

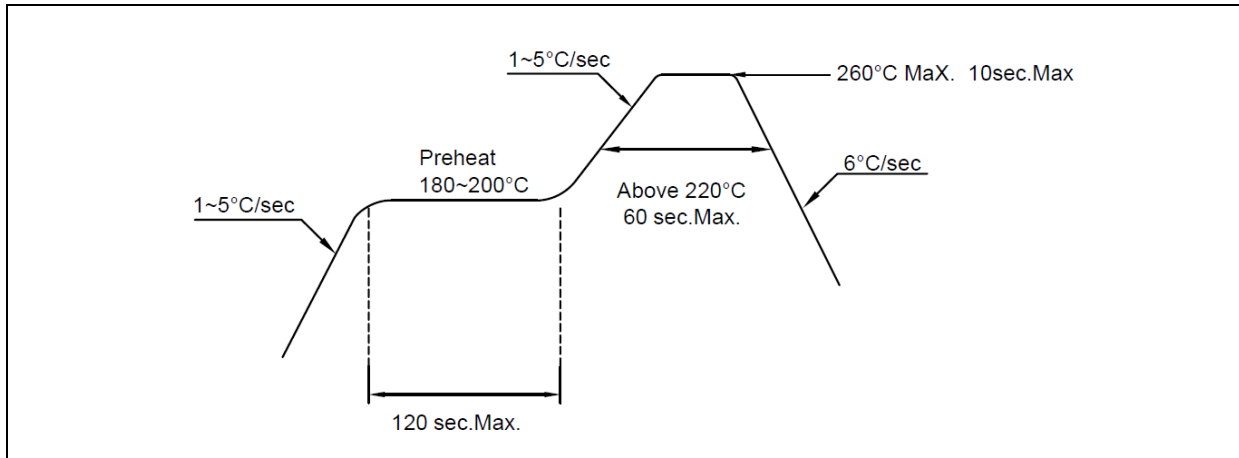
**Relative Intensity v.s. Wavelength**

**Directive Radiation**

## RECOMMENDED SOLDERING PROFILE:

---

Lead-free Solder:



Note:

1. Maximum reflow soldering: 2 times.
2. Before, during, and after soldering, should not apply stress on the components and PCB board.

**PACKING SPECIFICATION:**

Reel Dimension:

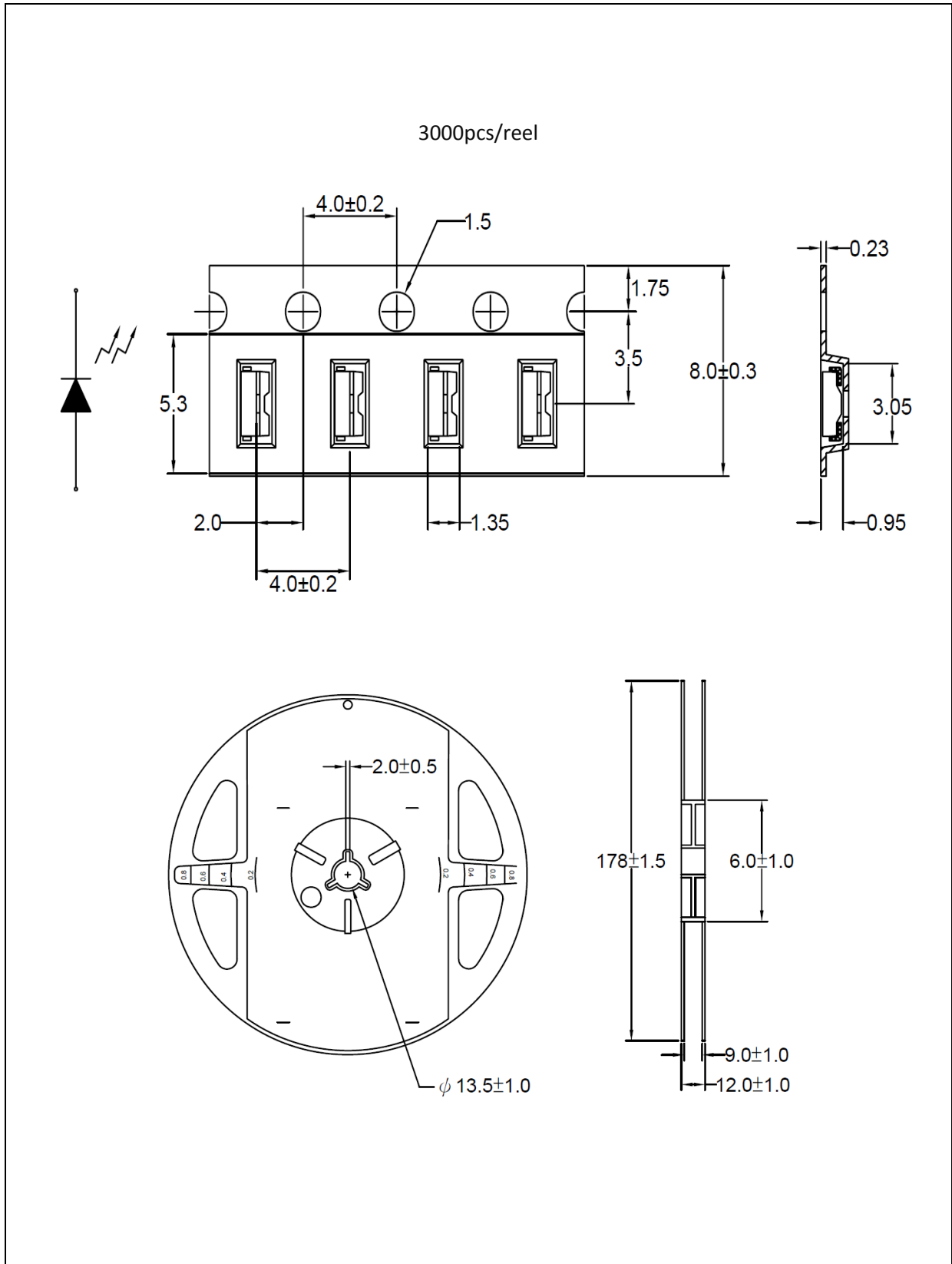

## PRECAUTIONS OF USE:

---

### Storage:

It is recommended to store the products in the following conditions:

- Humidity: 60% R.H. Max.
- Temperature: 5°C~30°C (41°F ~86°F).

Shelf life in sealed bag: 12 month at 5°C~30°C and <60% R.H.

Once the package is opened, the products should be used within a week. Otherwise, they should be kept in a damp-proof box with desiccating agent and apply baking at 60°C±5°C for 15hrs before use.

### Baking:

It is recommended to bake the LED before soldering if the pack has been unsealed for longer than 24hrs.

The suggested baking conditions are as followings:

- 70±3°C x 24hrs and <5%RH, taped / reel package.
- 100±3°C x 2hrs, bulk (loose) package.
- 130±3°C x 30min, bulk (loose) package.

It's normal to see slight color fading of carrier (light yellow) after baking in process.

### Testing Circuit:



Must apply resistor(s) for protection (over current proof).

### Cleaning:

Use alcohol-based cleaning solvents such as isopropyl alcohol to clean the LED carrier / package. Avoid putting any stress force directly on to the LED lens.

### ESD (Electrostatic Discharge):

Static Electricity or power surge will damage the LED. Use of a conductive wrist band or anti-electrostatic glove is recommended when handling the LED all time. All devices, equipment, machinery, work tables, and storage racks must be properly grounded.

In the events of manual working in process, make sure the devices are well protected from ESD at any time.



**REVISION RECORD:**

---

Version	Date	Summary of Revision
A1.0	20/12/2013	Datasheet set-up.
A1.1	17/10/2014	Update series name.
A1.2	06/11/2015	Part number adds -SV for side view.