



BRIGHTTEK
BRIGHTTEK (EUROPE) LIMITED

Brighten up The World With LED!



ISO/TS 16949:2009



BS EN ISO 14001:2004



QC 080000 IECQ HSPM

PRODUCT DATASHEET



- ▶ THT Through hole
- ▶ 24.5x6.3x10.8mm
- ▶ Photo Interrupter (PI)

NOP08L52



Release Date: 08 December 2023 Version: A1.2

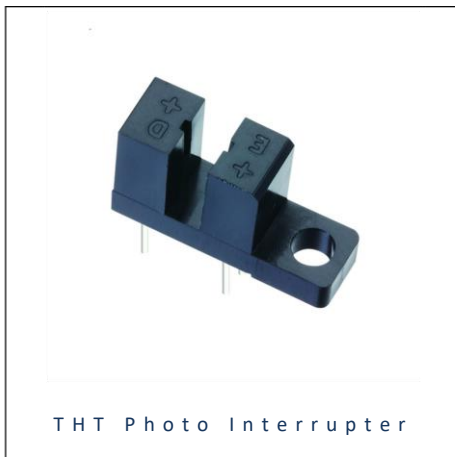

THT Photo Interrupter



FEATURES:

- **Package:** THT 4-Pins Photo Interrupter Block
- **Viewing Angle:** 40°
- **Infrared Peak Wavelength:** 940nm
- **Wavelength of Maxi. Sensitivity:** 940nm
- **Materials:**
 - Die: GaAlAs-GaAs (IR) / Silicon (PT)
- **Operating Temperature:** -40~+85°C
- **Storage Temperature:** -40~+100°C
- **Soldering methods:** Hand; Soldering Heat (DIP)
- **Packing:** Bulk in Carton

APPLICATIONS:

- Voltage Detector
- Monitor Sensor

CHARACTERISTICS:

Absolute Maximum Characteristics (Ta=25°C)

Parameter		Symbol	Ratings	Unit
IR	Power Dissipation	P _D	75	mW
	Continuous Forward Current	I _F	50	mA
	Peak Forward Current (pulse width: 10μs, duty cycle 1%)	I _{PF}	1	A
	Reverse Voltage	V _R	5	V
	Operating Temperature	T _{OPR}	-40~+85	°C
	Storage Temperature	T _{STG}	-40~+100	°C
PT	Power Dissipation	P _D	75	mW
	Emitter-Collector Breakdown Voltage	BV _{ECCO}	5	V
	Collector-Emitter Sustaining Voltage	V _{CE}	30	V
	Relative Humidity at 85°C	H _R	85	%
	Operating Temperature	T _{OPR}	-40~+85	°C
	Storage Temperature	T _{STG}	-40~+100	°C

Electrical & Optical Characteristics (Ta=25°C)

Parameter	Symbol	Values			Unit	Test Condition	
		Min.	Typ.	Max.			
Input	Forward Voltage	V _F	---	1.2	1.5	V	I _F =20mA V _R =4V
	Reverse Leakage Current	I _R	---	---	10	μA	
Output	Dark Current	I _d	---	---	100	nA	V _{CE} =10V E _e =0mW/cm ²
	Junction Capacitance	C _T	---	---	---	pF	
Coupled	Output Current	I _C	0.5	---	---	mA	I _F =20mA V _{CE} =5V I _C =2mA R _L =1KΩ
	Rise Time	T _r	---	5	---	μS	
	Fall Time	T _f	---	5	---	μS	

OUTLINE DIMENSION:

Package Dimension:

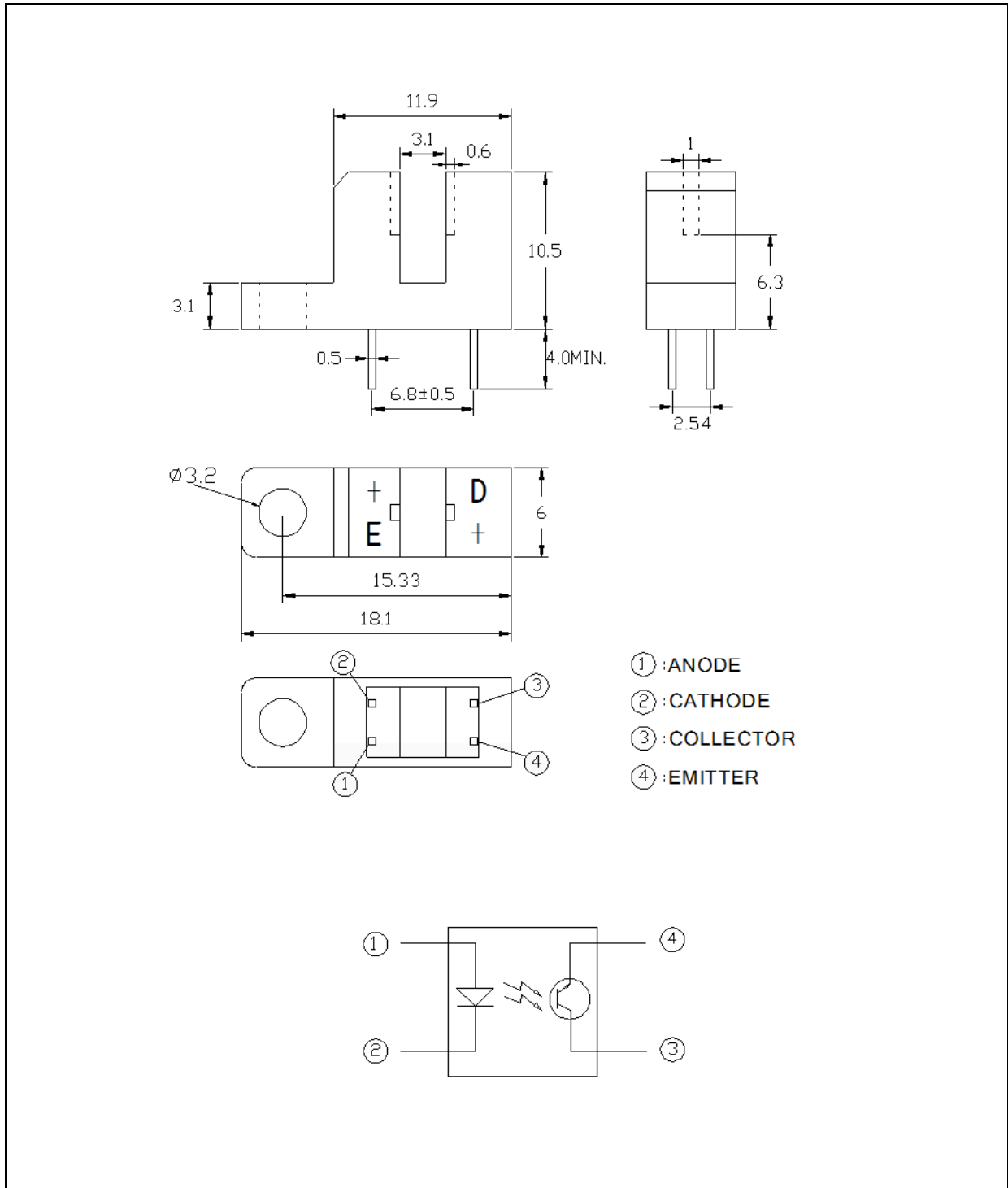

1. All dimensions are in millimetre (mm).
2. Tolerance $\pm 0.2\text{mm}$, unless otherwise noted.

ELECTRO-OPTICAL CHARACTERISTICS (IR):

Relative Intensity v.s. Forward Current

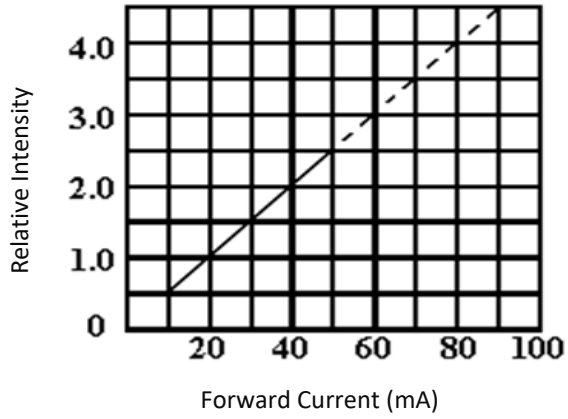

Forward Current v.s. Forward Voltage

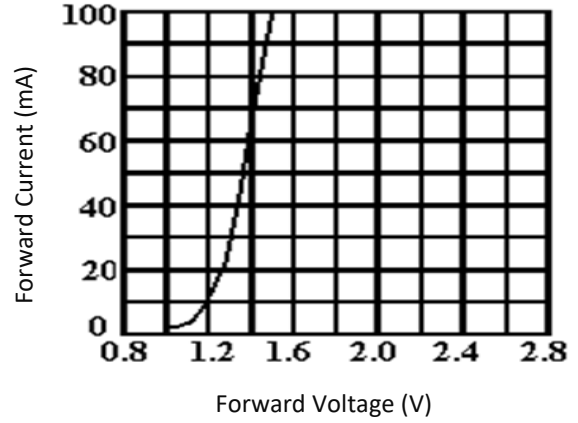

Relative Intensity v.s. Temperature

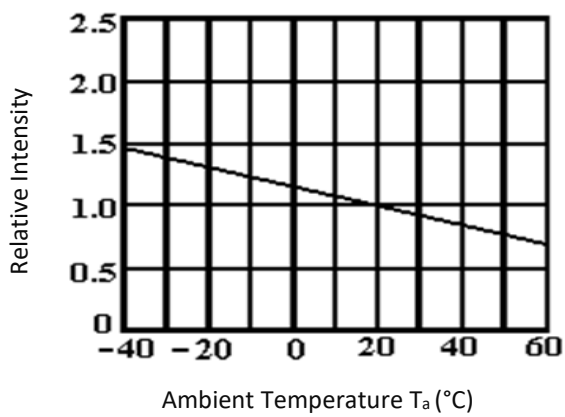

Spectral Distribution

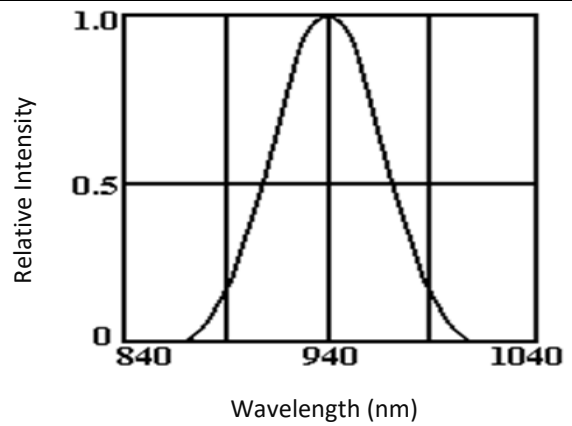

ELECTRO-OPTICAL CHARACTERISTICS (PT):

Ambient Temperature v.s. Collect Dark Current

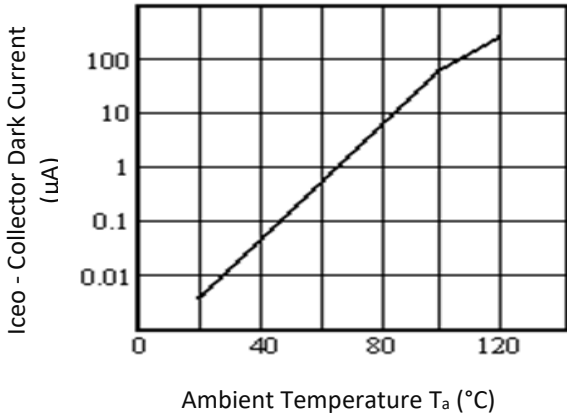

Ambient Temp. v.s. Normalized Collect Current

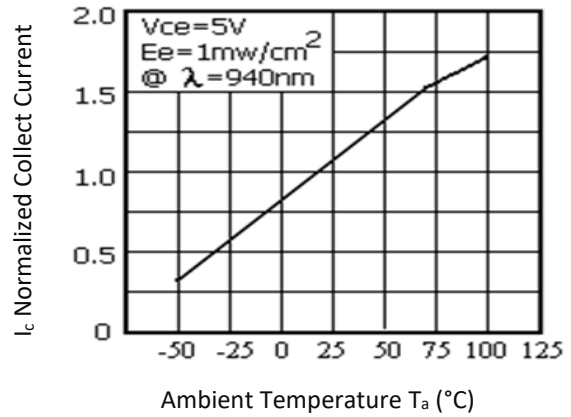

Rise and Fall Time v.s. Load Resistance

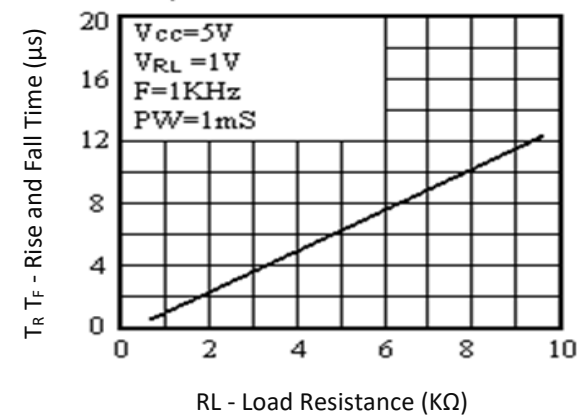

Forward Collector Current v.s. Irradiance

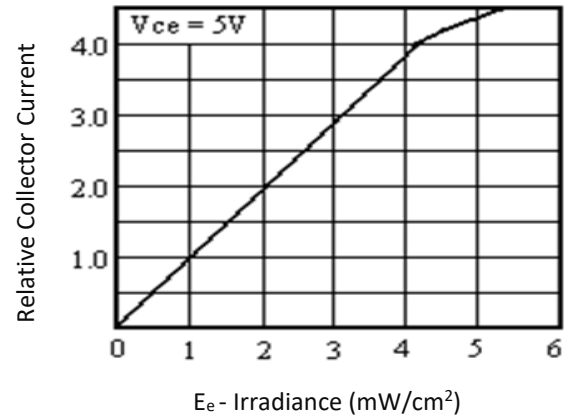

Relative Intensity v.s. Wavelength

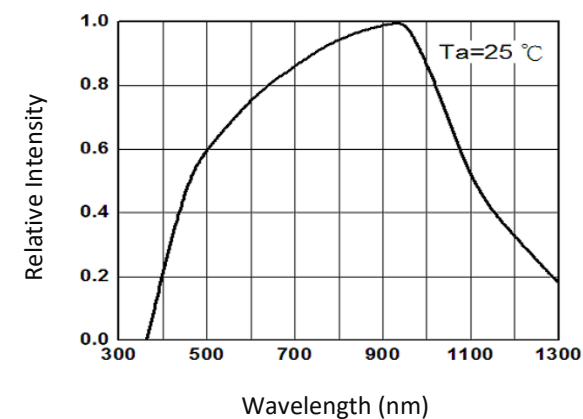

RECOMMENDED SOLDERING PROFILE:

Hand Solder (Solder Iron):

- Temperature at tip of iron: 350°C Max.
- Soldering Time: 3 seconds \pm 1 sec.

Solder Heat (DIP):

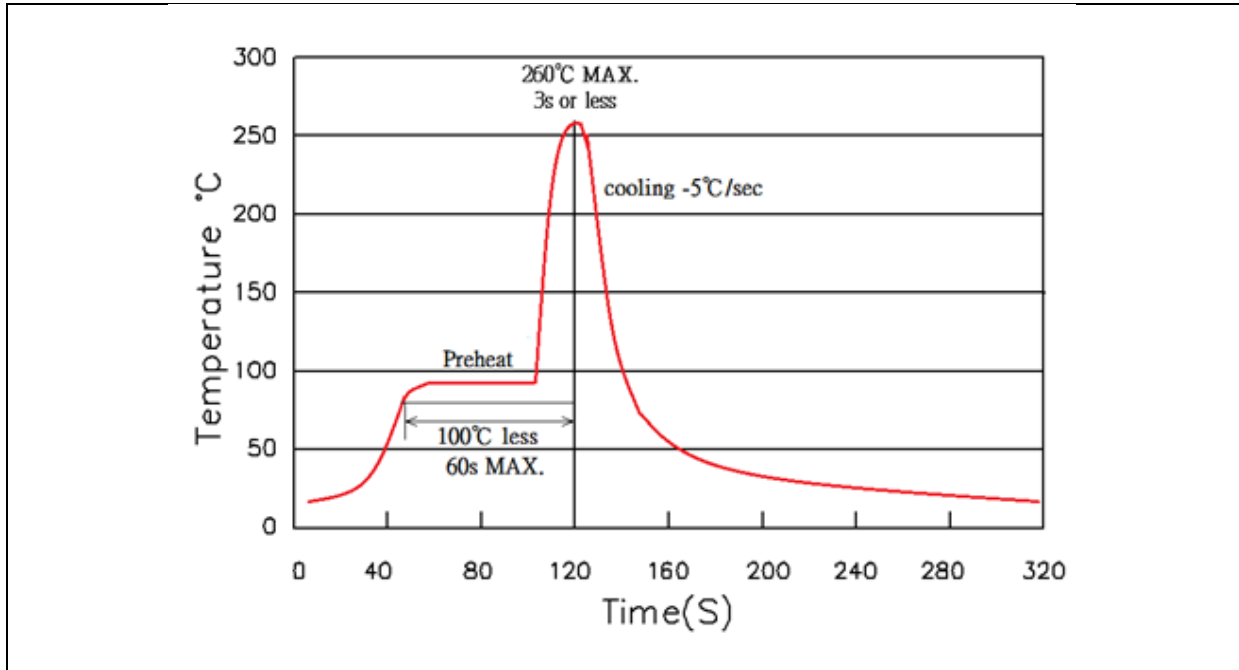

Note:

1. Recommend reflow temperature 245°C. The maximum soldering temperature should be limited to 260°C.
2. Maximum reflow soldering: 1 times.
3. Before, during, and after soldering, should not apply stress on the components and PCB board.

PRECAUTIONS OF USE:

Storage:

It is recommended to store the products in the following conditions:

- Humidity: 60% R.H. Max.
- Temperature: 5°C~30°C (41°F ~86°F).

Shelf life in sealed bag: 12 months at 5°C~30°C and <60% R.H.

Once the package is opened, the products should be used within a year. Otherwise, they should be kept in a damp-proof box with desiccating agent <10% R.H. and apply baking before use.

Baking:

It is recommended to bake the LED before soldering if the pack has been unsealed for longer than 24hrs.

The suggested baking conditions are as followings:

- 60±3°C x 36hrs and <5%RH, taped / reel package.

It's normal to see slight color fading of carrier (light yellow) after baking in process.

Testing Circuit:

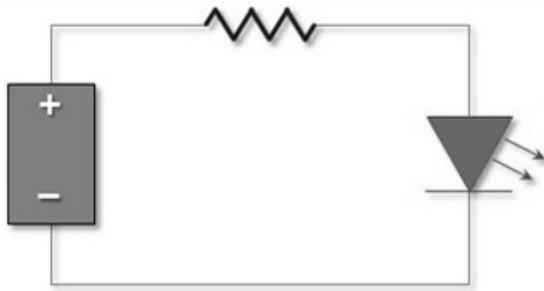

Must apply resistor(s) for protection (over current proof).

Cleaning:

Use alcohol-based cleaning solvents such as isopropyl alcohol to clean the LED carrier / package. Avoid putting any stress force directly on to the LED lens.

ESD (Electrostatic Discharge):

Static Electricity or power surge will damage the LED. Use of a conductive wrist band or anti-electrosatic glove is recommended when handling the LED all time. All devices, equipment, machinery, work tables, and storage racks must be properly grounded.

In the events of manual working in process, make sure the devices are well protected from ESD at any time.

REVISION RECORD:

Version	Date	Summary of Revision
A1.0	16/04/2023	Datasheet set-up.
A1.1	23/11/2023	Revise status as not moisture sensitive.
A1.2	08/12/2023	Revise storage condition.