



BRIGHTTEK
BRIGHTTEK (EUROPE) LIMITED

Brighten up The World With LED!



ISO/TS 16949:2009



BS EN ISO 14001:2004



QC 080000 IECQ HSPM

PRODUCT DATASHEET



- ▶ PLCC6 Top View
- ▶ 3528 1.8t
- ▶ Red (622nm) / True Green (527nm) / Blue (470nm)

NOM63S65



Release Date: 25 April 2023 Version: A1.1



3 5 2 8 1 . 8 5 t S e r i e s

3528 1.8t Series



FEATURES (Red/Green/Blue):

- **Package:** PLCC6 Top View Black Surface LED SMT Package
- **Forward Current:** 20/20/20mA*
- **Forward Voltage (typ.):** 2.0/2.8/3.0V
- **Luminous Intensity (typ.):** 915/2066/230mcd@20mA
- **Colour:** Red/Green/Blue
- **Wavelength:** 622/527/470nm
- **Viewing Angle:** 120/120/120°
- **Materials:**
 - Die: AlGaInP-GaAs/InGaN/InGaN
 - Resin: Epoxy (Water Clear)
- **Operating Temperature:** -40~+100°C
- **Storage Temperature:** -40~+100°C
- **Grouping Parameters:**
 - Forward voltage
 - Luminous intensity
 - Dominant wavelength
- **Soldering Methods:** Reflow soldering
- **MSL Level:** acc. to JEDEC Level 3
- **Packing:** 8mm tape with max.2000/reel, ø180mm (7")

APPLICATIONS:

- Indicator
- Dashboard
- 3C Application
- Display
- Decoration Lighting

* In the order of Red/Green/Blue.

CHARACTERISTICS:

Absolute Maximum Characteristics (Ta=25°C)

Parameter	Symbol	Ratings	Unit
Forward Current	I _F	30/30/30*	mA
Peak Forward Current Duty 1/8, f=1kHz	I _{FP}	125	mA
Reverse Voltage	V _R	5	V
Reverse Current @5V	I _R	10	μA
Power Dissipation	P _D	75/102/111	mW
Operating Temperature	T _{OPR}	-40~+100	°C
Storage Temperature	T _{STG}	-40~+100	°C

- * In the order of Red/Green/Blue.

Electrical & Optical Characteristics (Ta=25°C)

Parameter	Symbol	Values			Unit	Test Condition
		Min.	Typ.	Max.		
Forward Voltage	V _F	1.7/2.5/2.8*	2.0/2.8/3.0	2.5/3.4/3.7	V	I _F =20mA
Luminous Intensity	I _v	630/1600/160	915/2066/230	1600/4000/400	mcd	I _F =20mA
Dominant Wavelength	λ _D	615/520/465	622/527/470	630/530/475	nm	I _F =20mA
Peak Wavelength	λ _P	---	630/521/467	---	nm	I _F =20mA
Spectral Line Half Bandwidth	Δλ	---	19/30/22	---	nm	I _F =20mA
Viewing Angle	2θ _{1/2}	---	120	---	deg	I _F =20mA

- * In the order of Red/Green/Blue.
- Luminous intensity (I_v) ±15%, Forward Voltage (V_F) ±0.1V, Viewing angle(2θ_{1/2}) ±5%.

OUTLINE DIMENSION:

Package Dimension:

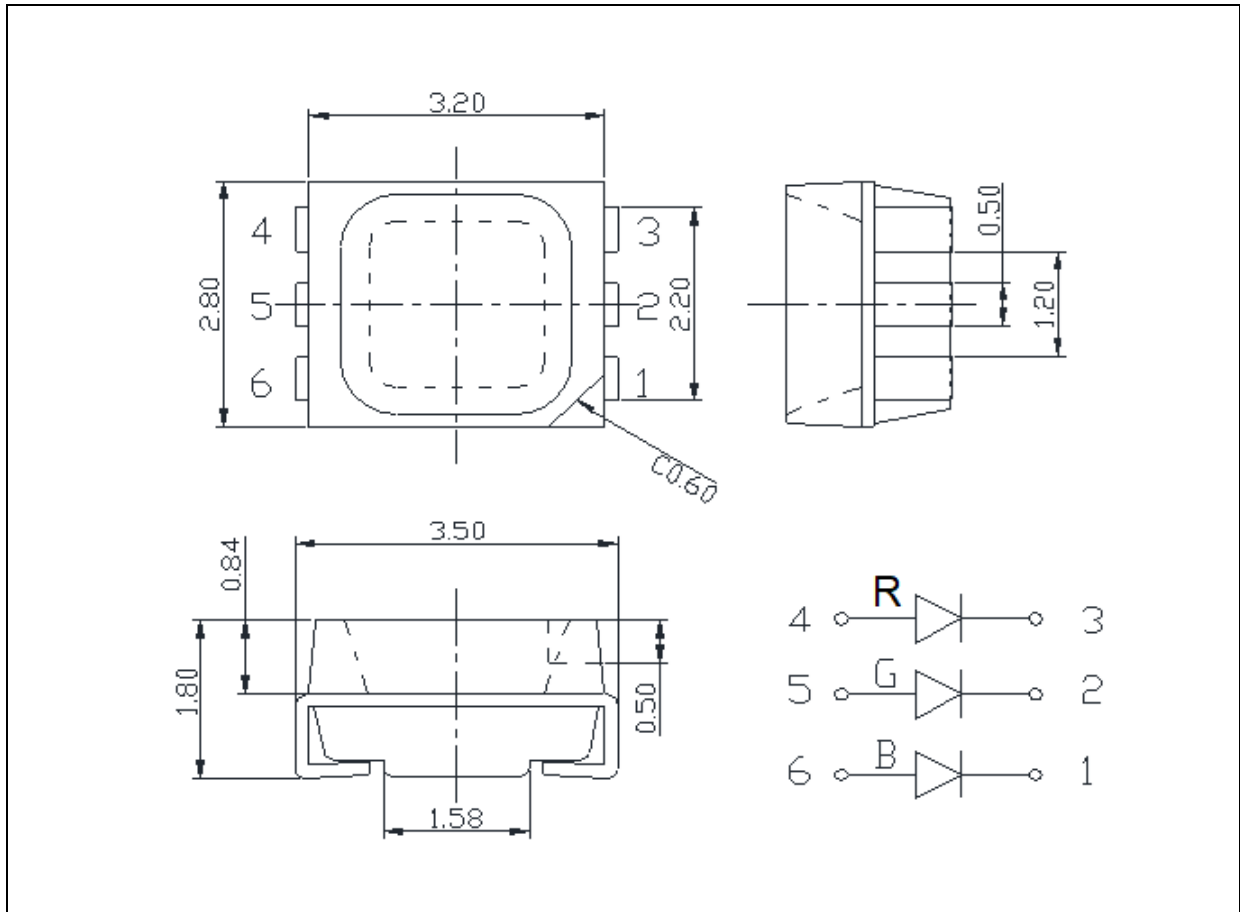

1. All dimensions are in millimetre (mm).
2. Tolerance ± 0.2 mm, unless otherwise noted.

Recommended Soldering Pad Dimension:

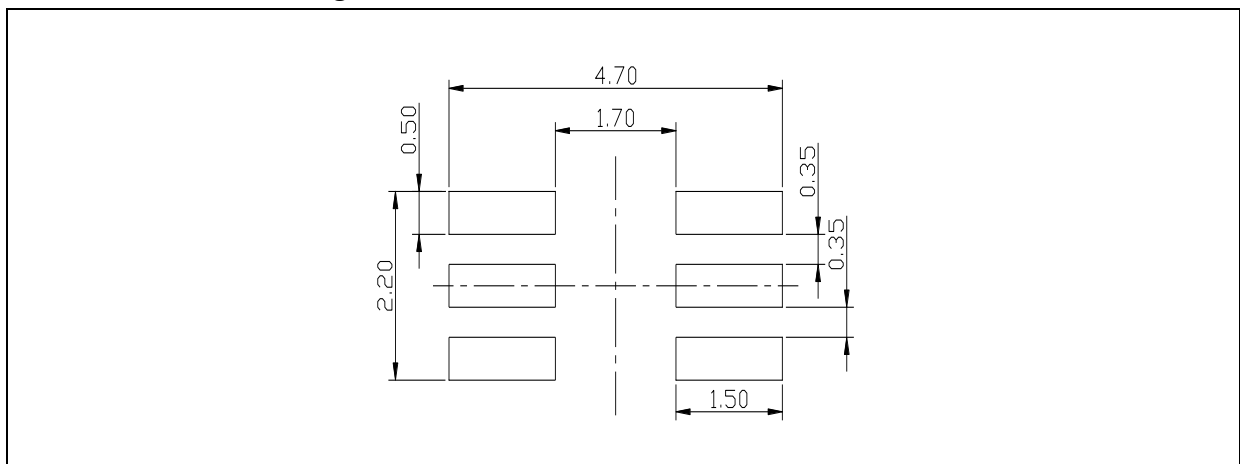

1. Dimensions are in millimetre (mm).
2. Tolerance ± 0.1 mm with angle tolerance $\pm 0.5^\circ$.

BINNING GROUPS:

 Forward Voltage Classifications ($I_F = 20\text{mA}$):

	Code	Min.	Max.	Unit
Red	□	1.7	2.5	V
Green	e	2.5	2.8	V
	f	2.8	3.1	
	g	3.1	3.4	
Blue	f	2.8	3.1	V
	g	3.1	3.4	
	h	3.4	3.7	

 Luminous Intensity Classifications ($I_F = 20\text{mA}$):

	Code	Min.	Max.	Unit
Red	R	630	800	mcd
	S	800	1000	
	T	1000	1250	
	U	1250	1600	
Green	V	1600	2000	mcd
	W	2000	2500	
	X	2500	3200	
	Y	3200	4000	
Blue	L	160	200	mcd
	M	200	250	
	N	250	320	
	O	320	400	

BINNING GROUPS:

 Wavelength Classifications ($I_F = 20\text{mA}$):

	Code	Min.	Max.	Unit
Red	s	615	620	nm
	u	620	625	
	v	625	630	
Green	U	520	522.5	nm
	V	522.5	525	
	W	525	527.5	
	X	527.5	530	
Blue	G	465	467.5	nm
	H	467.5	470	
	I	470	472.5	
	J	472.5	475	

Example Group Name on Label:

□St gWW gMH 20 (in order of R/G/B):

- **□St20** = **□** (1.7~2.5V) ▶ **S** (800~1000mcd) ▶ **t** (620~625nm) ▶ **20** ($I_F=20\text{mA}$)
- **gWW20** = **g** (3.1~3.4V) ▶ **W** (2000~2500mcd) ▶ **W** (525~527.5nm) ▶ **20** ($I_F=20\text{mA}$)
- **gOH20** = **g** (3.1~3.4V) ▶ **O** (200~250mcd) ▶ **H** (467.5~470nm) ▶ **20** ($I_F=20\text{mA}$)

ELECTRO-OPTICAL CHARACTERISTICS (RED):

Relative Spectral Distribution

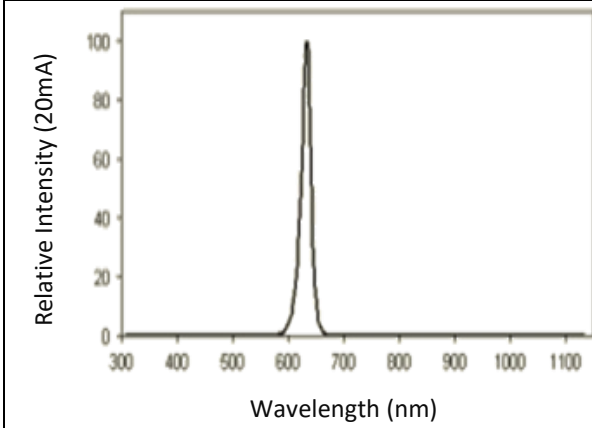

Forward Current v.s. Forward Voltage

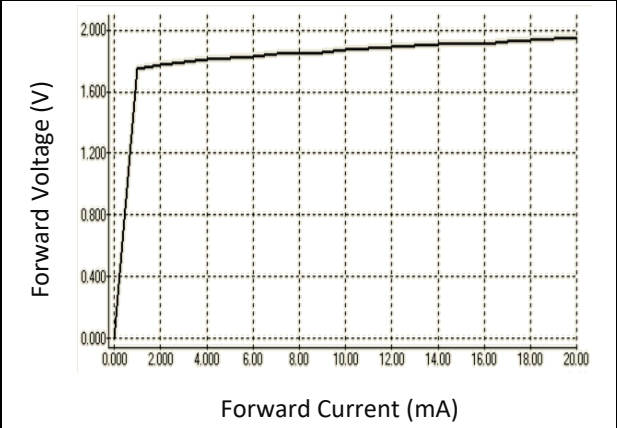

Directive Radiation

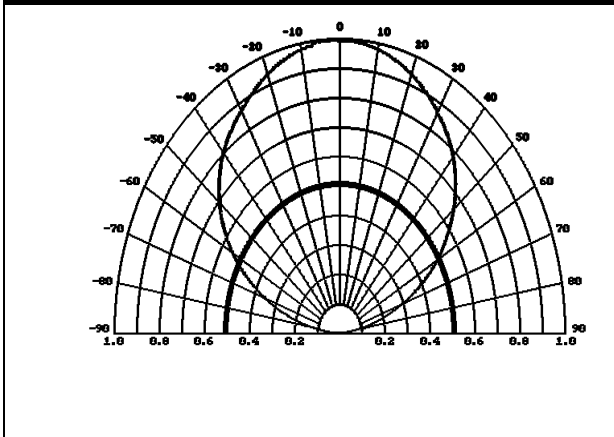

ELECTRO-OPTICAL CHARACTERISTICS (GREEN):

Relative Spectral Distribution

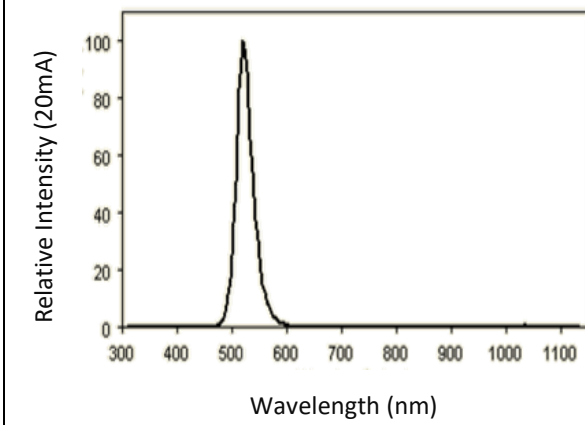

Forward Current v.s. Forward Voltage

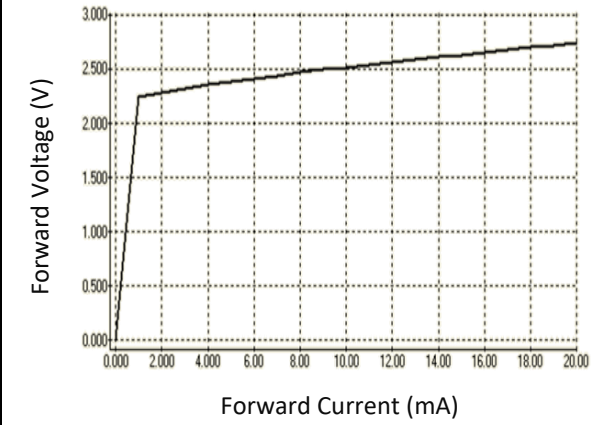

Directive Radiation

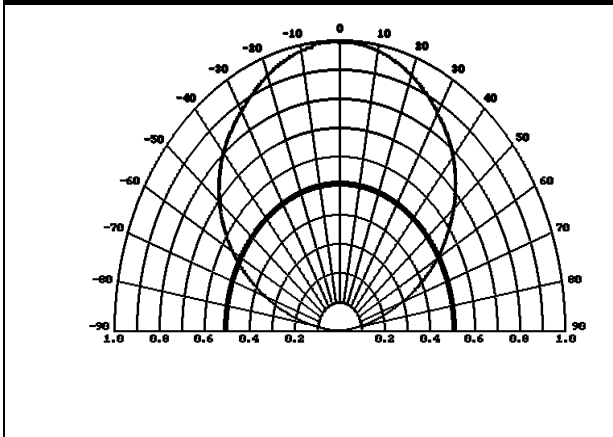

ELECTRO-OPTICAL CHARACTERISTICS (BLUE):

Relative Spectral Distribution

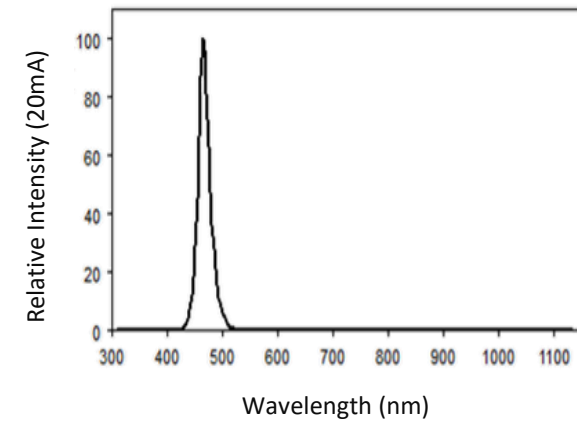

Forward Current v.s. Forward Voltage

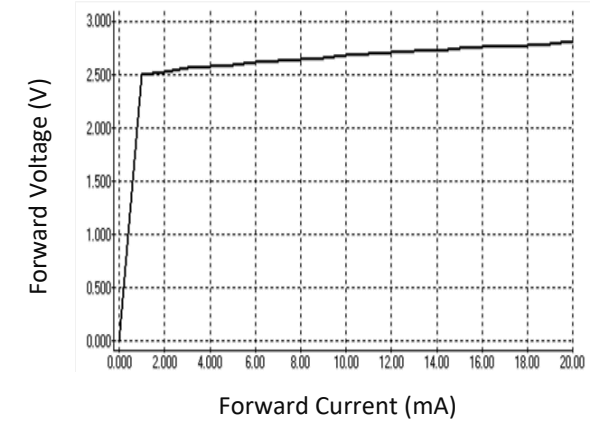

Directive Radiation

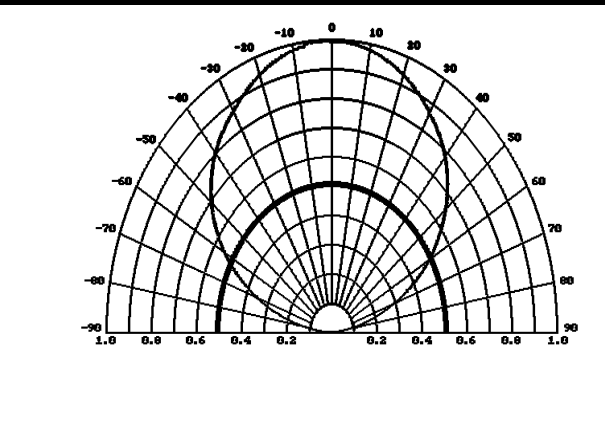

RECOMMENDED SOLDERING PROFILE:

Reflow Solder:

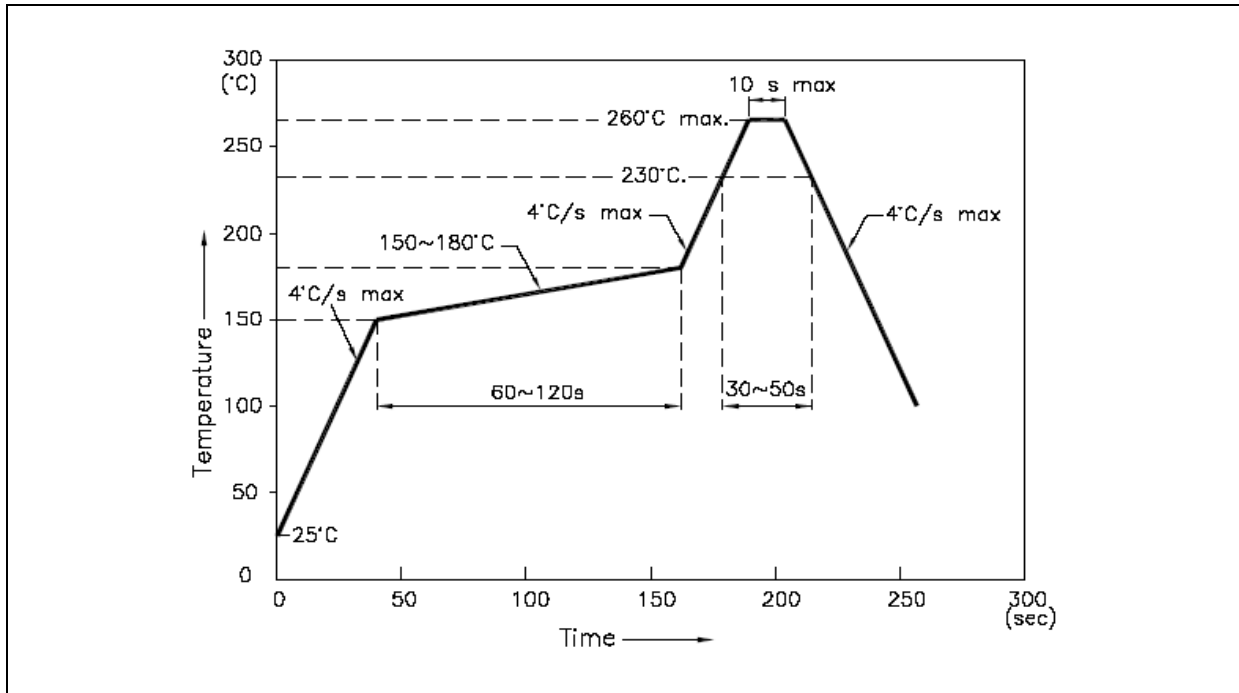

Note:

1. Recommend reflow temperature 245°C. The maximum soldering temperature should be limited to 260°C.
2. Maximum reflow soldering: 2 times.
3. Before, during, and after soldering, should not apply stress on the components and PCB board.



PACKING SPECIFICATION:

Reel Dimension:

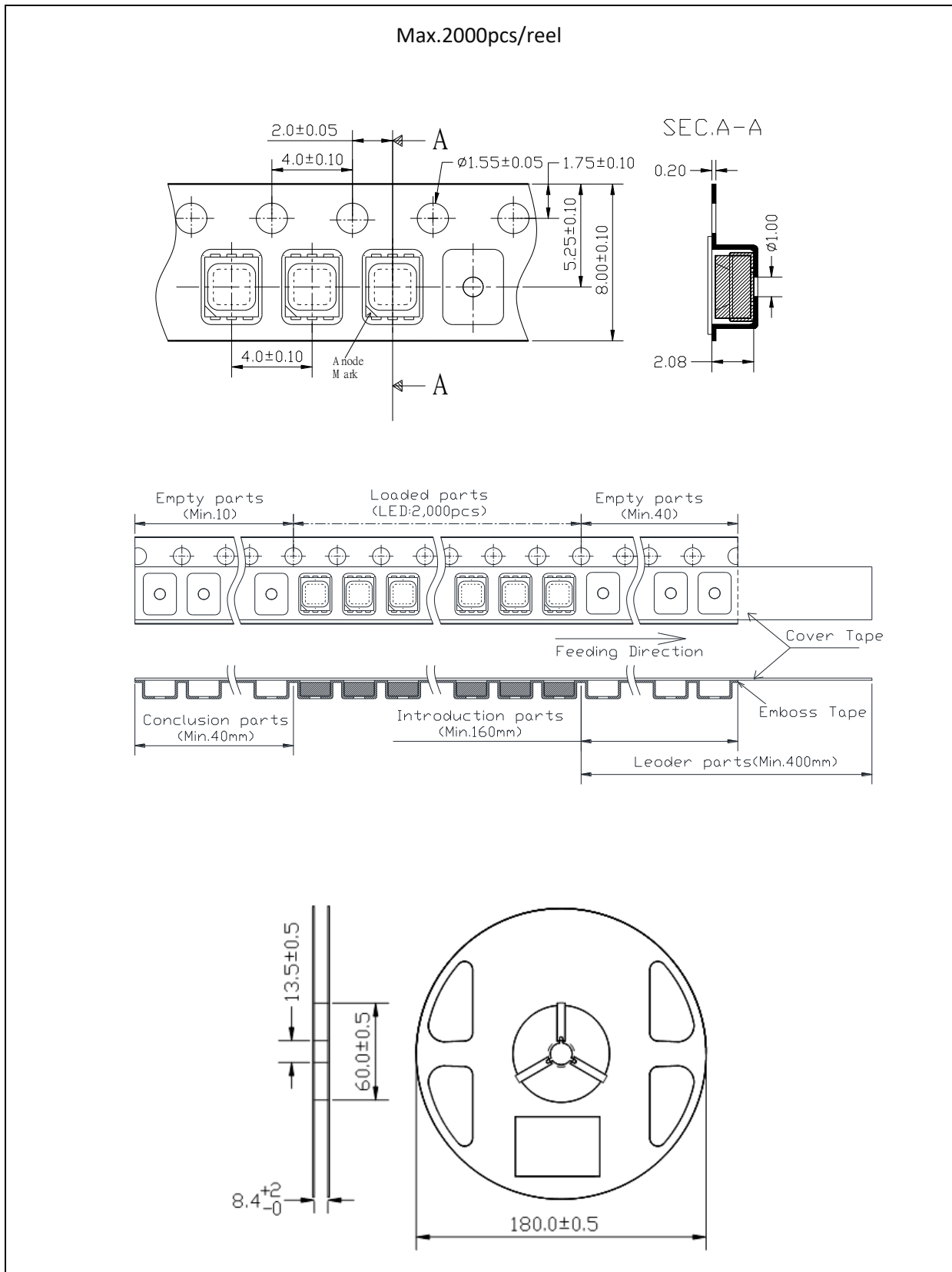

PRECAUTIONS OF USE:

Storage:

It is recommended to store the products in the following conditions:

- Humidity: 60% R.H. Max.
- Temperature: 5°C~30°C (41°F ~86°F).

Shelf life in sealed bag: 12 months at 5°C~30°C and <60% R.H.

Once the package is opened, the products should be used within a week. Otherwise, they should be kept in a damp-proof box with desiccating agent <10% R.H. and apply baking at before use.

Baking:

It is recommended to bake the LED before soldering if the pack has been unsealed for longer than 24hrs. The suggested baking conditions are as followings:

- 60±5°C x 24hrs and <5%RH, taped / reel package.

It's normal to see slight color fading of carrier (light Blue) after baking in process.

Testing Circuit:

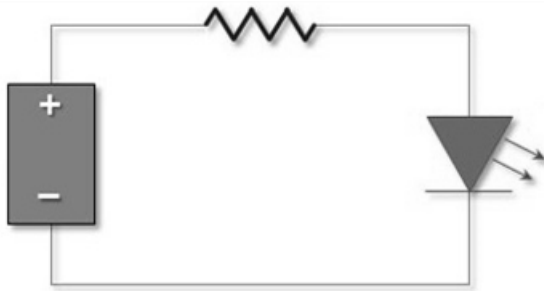

Must apply resistor(s) for protection (over current proof).

Cleaning:

Use alcohol-based cleaning solvents such as isopropyl alcohol to clean the LED carrier / package. Avoid putting any stress force directly on to the LED lens.

ESD (Electrostatic Discharge):

Static Electricity or power surge will damage the LED. Use of a conductive wrist band or anti-electrosatic glove is recommended when handling the LED all time. All devices, equipment, machinery, work tables, and storage racks must be properly grounded.

In the events of manual working in process, make sure the devices are well protected from ESD at any time.

REVISION RECORD:

Version	Date	Summary of Revision
A1.0	25/08/2021	Datasheet set-up.
A1.1	25/04/2023	New datasheet format.