



BRIGHTTEK
BRIGHTTEK (EUROPE) LIMITED

Brighten up The World With LED!



ISO/TS 16949:2009



BS EN ISO 14001:2004



QC 080000 IECQ HSPM

PRODUCT DATASHEET



- ▶ PLCC Side View SMD
- ▶ 4516SV 1.7t Series
- ▶ Red (622nm) / Green (522nm) / Blue (467nm)

NOM63S22SV



Release Date: 28 November 2022 Version: A1.0



APPLICATIONS:

- 3C Application
- Decoration Lighting
- Flat Backlight for LCD

4516SV 1.7t Series

RoHS Compliant



FEATURES (Red/Green/Blue*):

- **Package:** PLCC6 RGB Side View SMD Package
- **Forward Current:** 20/20/20mA
- **Forward Voltage (typ.):** 2.1/3.1/3.2V
- **Luminous Flux (typ.):** 650/1800/420mcd@20mA
- **Colour:** Red/Green/Blue
- **CCT/Wavelength:** 622/522/467nm
- **Viewing angle:** 120/120/120°
- **Materials:**
 - Resin: Silicon (White Diffused)
- **Operating Temperature:** -40~+85°C
- **Storage Temperature:** -40~+105°C
- **ESD:** 1000 (HBM)
- **Grouping parameters:**
 - Forward voltage
 - Luminous intensity
 - Dominant Wavelength
- **Soldering methods:** Reflow soldering
- **MSL Level:** 3 according to JEDEC
- **Packing:** 12mm tape with max.2000pcs/reel, ø180mm (7")

CHARACTERISTICS:

Absolute Maximum Characteristics (Ta=25°C)

Parameter	Symbol	Ratings	Unit
Forward Current	I _F	20/30/30*	mA
Pulse Forward Current (duty 1/10; width 0.1ms)	I _{MAX}	80	mA
Power Dissipation	P _D	50/100/100	mW
Reverse Voltage	V _R	5	V
Reverse Current @5V	I _R	10	μA
Electrostatic Discharge (HBM)	ESD	1000	V
Junction Temperature	T _j	110	°C
Soldering Temperature	T _{SOL}	260	°C
Operating Temperature	T _{OPR}	-40~+85	°C
Storage Temperature	T _{STG}	-40~+105	°C

1. * In the order of Red/Green/Blue.

Electrical & Optical Characteristics (Ta=25°C)

Parameter	Symbol	Values			Unit	Test Condition
		Min.	Typ.	Max.		
Red - Forward Voltage	V _F	1.8	2.1	2.6	V	I _F =20mA
Red - Luminous Intensity	I _V	385	650	1100	mcd	I _F =20mA
Red - Wavelength	W _P	615	---	630	nm	I _F =20mA
Green - Forward Voltage	V _F	2.8	3.1	3.6	V	I _F =20mA
Green - Luminous Intensity	I _V	1060	1800	3040	mcd	I _F =20mA
Green - Wavelength	W _P	515	---	530	nm	I _F =20mA
Blue - Forward Voltage	V _F	2.8	3.2	3.6	V	I _F =20mA
Blue - Luminous Intensity	I _V	250	420	710	mcd	I _F =20mA
Blue - Wavelength	W _P	460	---	475	nm	I _F =20mA
Viewing Angle	2θ _{1/2}	---	120	---	deg	I _F =20mA

1. Luminous intensity (I_V) ±10%, Forward Voltage (V_F) ±0.1V, Viewing angle(2θ_{1/2}) ±5%, Wavelength (λ) ±1nm.
2. We will amend the bin code to maintain bins centralization, and we provide the luminous intensity 1.25double per bin and the dominant wavelength is per 5/5/5nm of the R/G/B per bins.

OUTLINE DIMENSION:

Package Dimension:

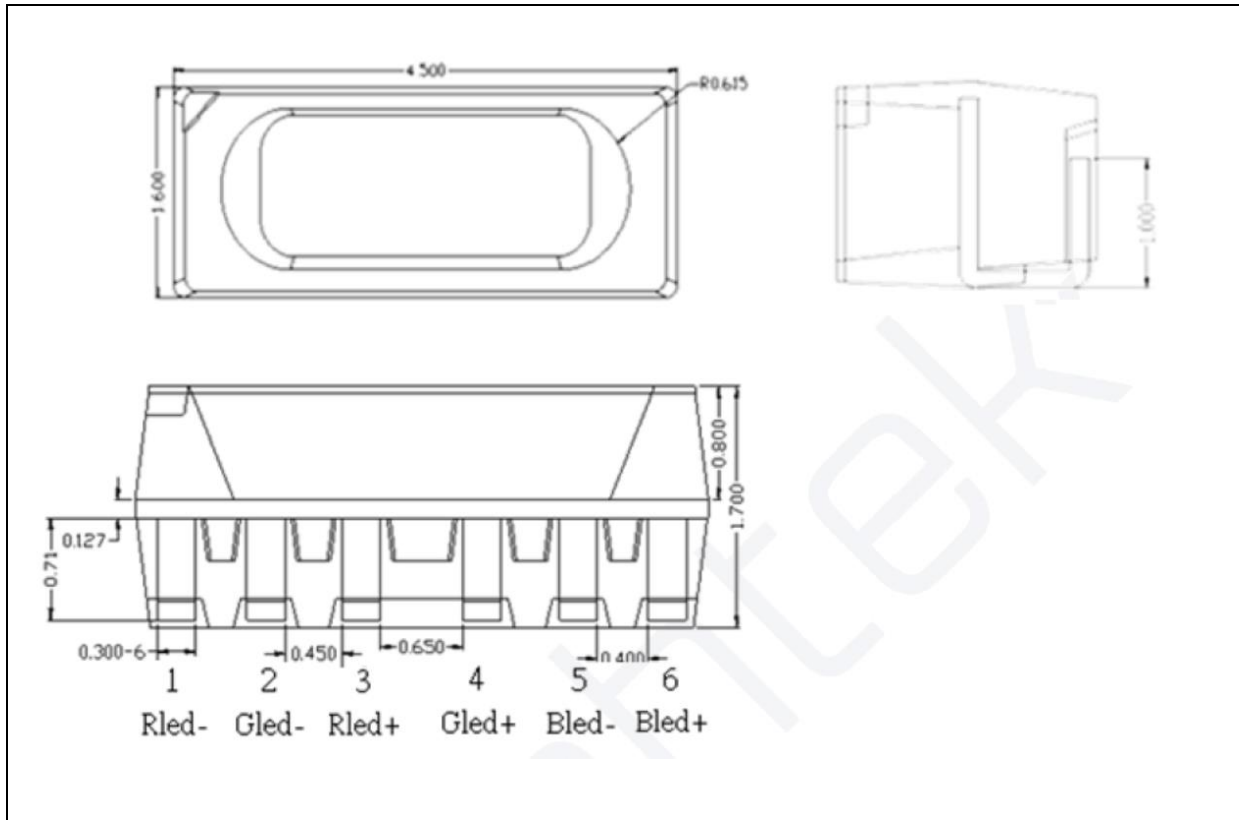

1. All dimensions are in millimetre (mm).
2. Tolerance ± 0.1 mm, unless otherwise noted.

Recommended Soldering Pad Dimension:

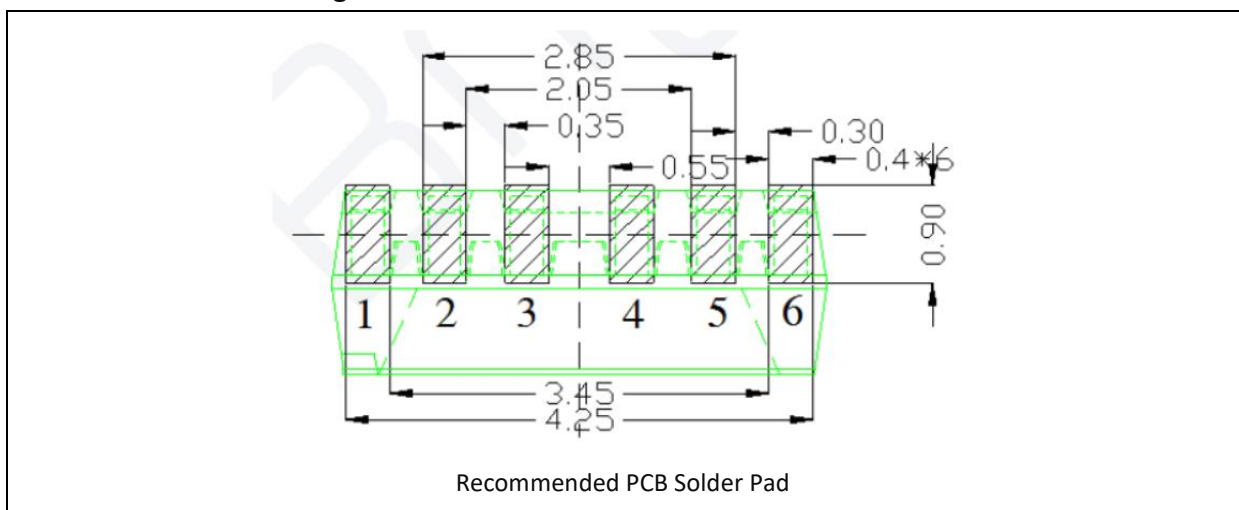

Recommended PCB Solder Pad

1. Dimensions are in millimetre (mm).
2. Tolerance ± 0.1 mm with angle tolerance $\pm 0.5^\circ$.

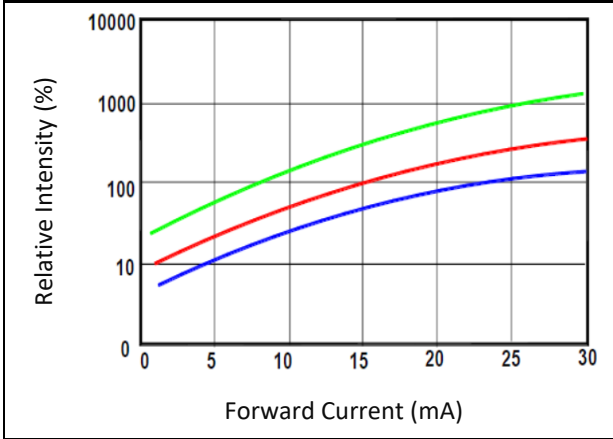
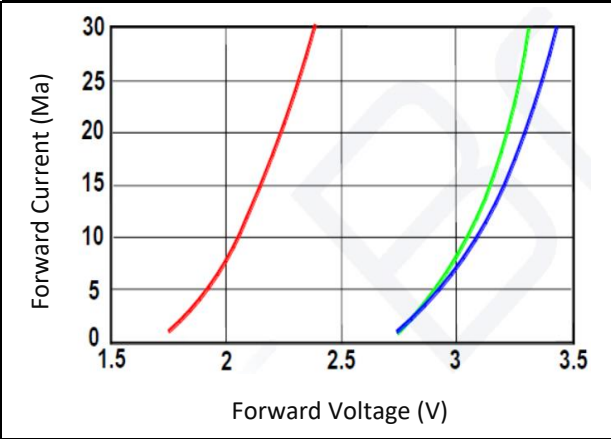
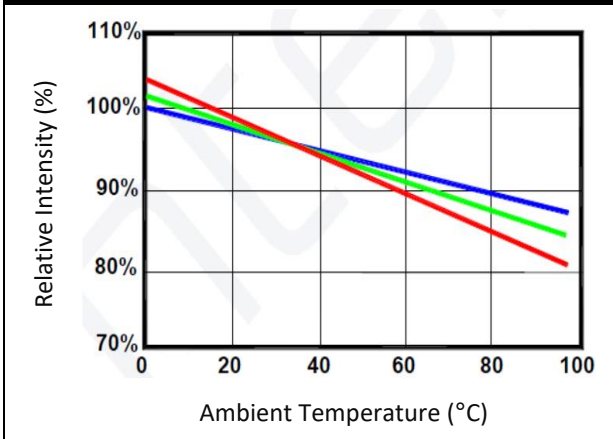
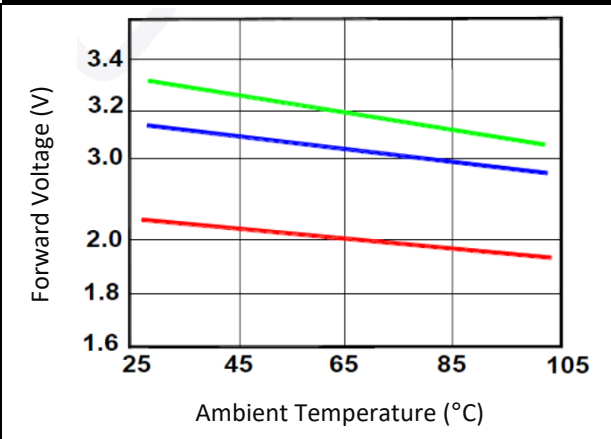
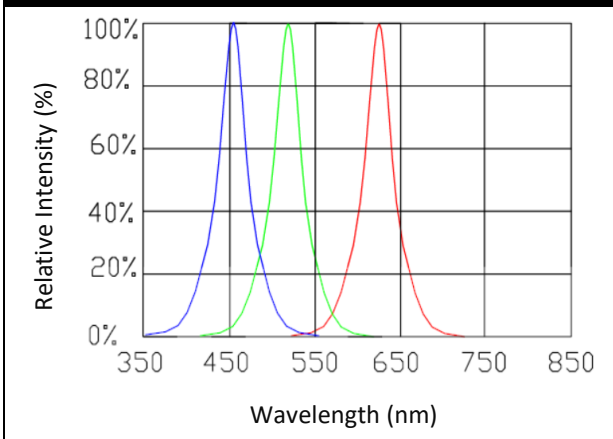
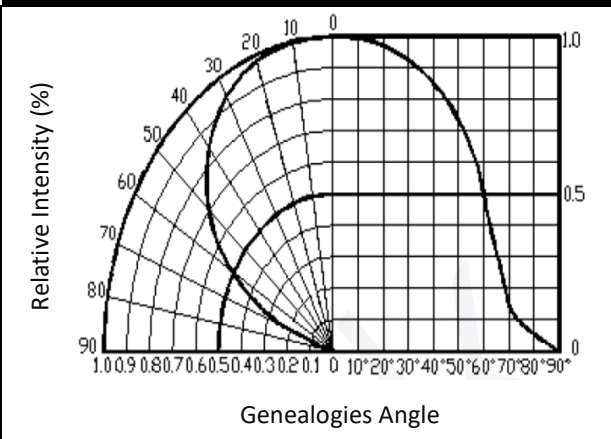
ELECTRO-OPTICAL CHARACTERISTICS:
Relative Intensity v.s. Forward Current

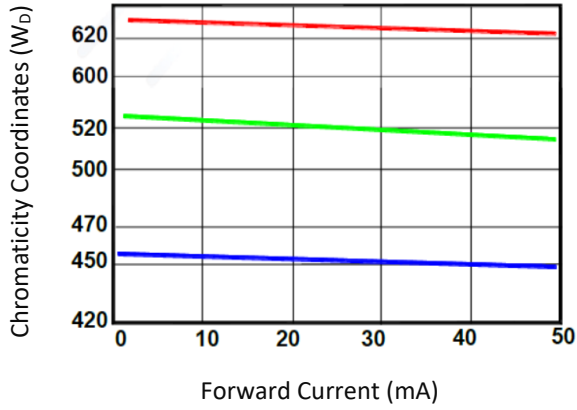
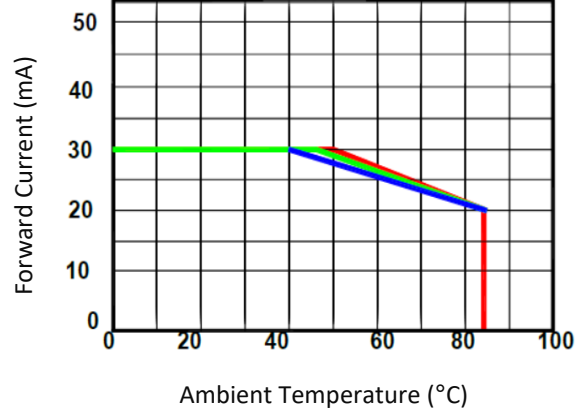
Forward Current v.s. Forward Voltage

Relative Intensity v.s. Ambient Temperature

Forward Voltage v.s. Ambient Temperature

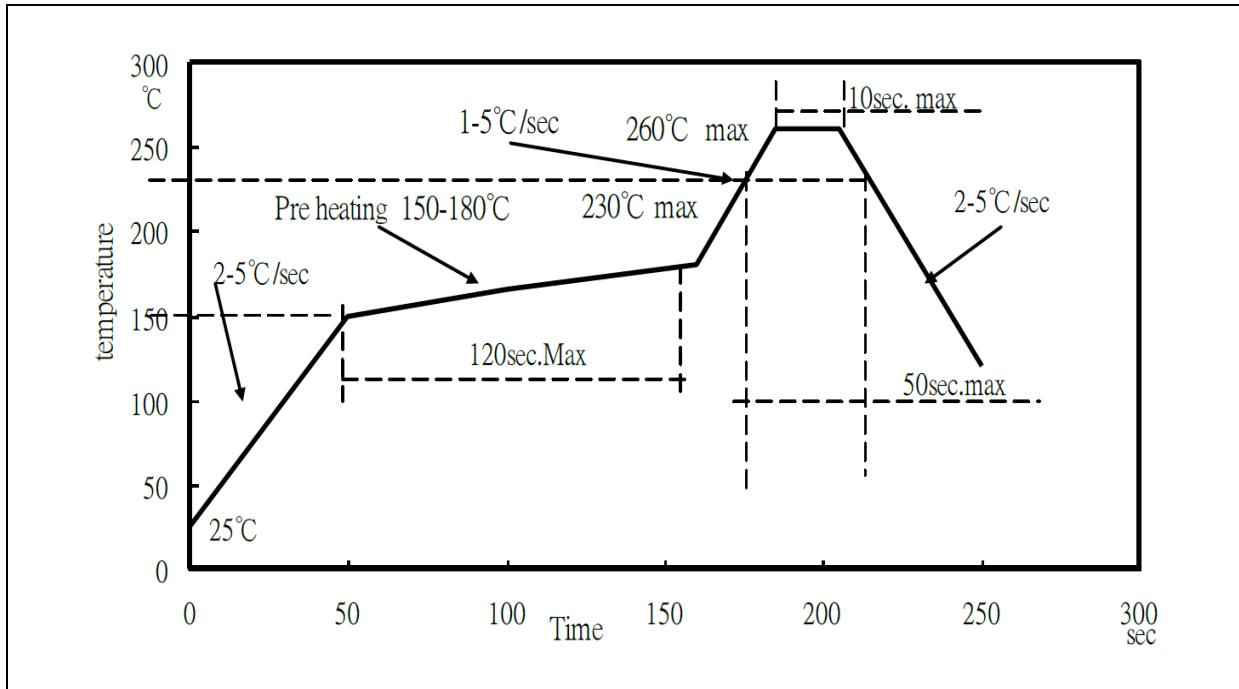
Relative Spectral Distribution

Directive Radiation

ELECTRO-OPTICAL CHARACTERISTICS:
Colours Shifting v.s. Forward Current

Maximum Current v.s. Ambient Temperature

RECOMMENDED SOLDERING PROFILE:

Lead-free Solder:



Note:

1. Maximum reflow soldering: 1 time.
2. Recommended reflow temperature is 240°C; the maximum soldering temperature should be limited to 260°C.
3. Before, during, and after soldering, should not apply stress on the components and PCB board.

PACKING SPECIFICATION:

Reel Dimension:

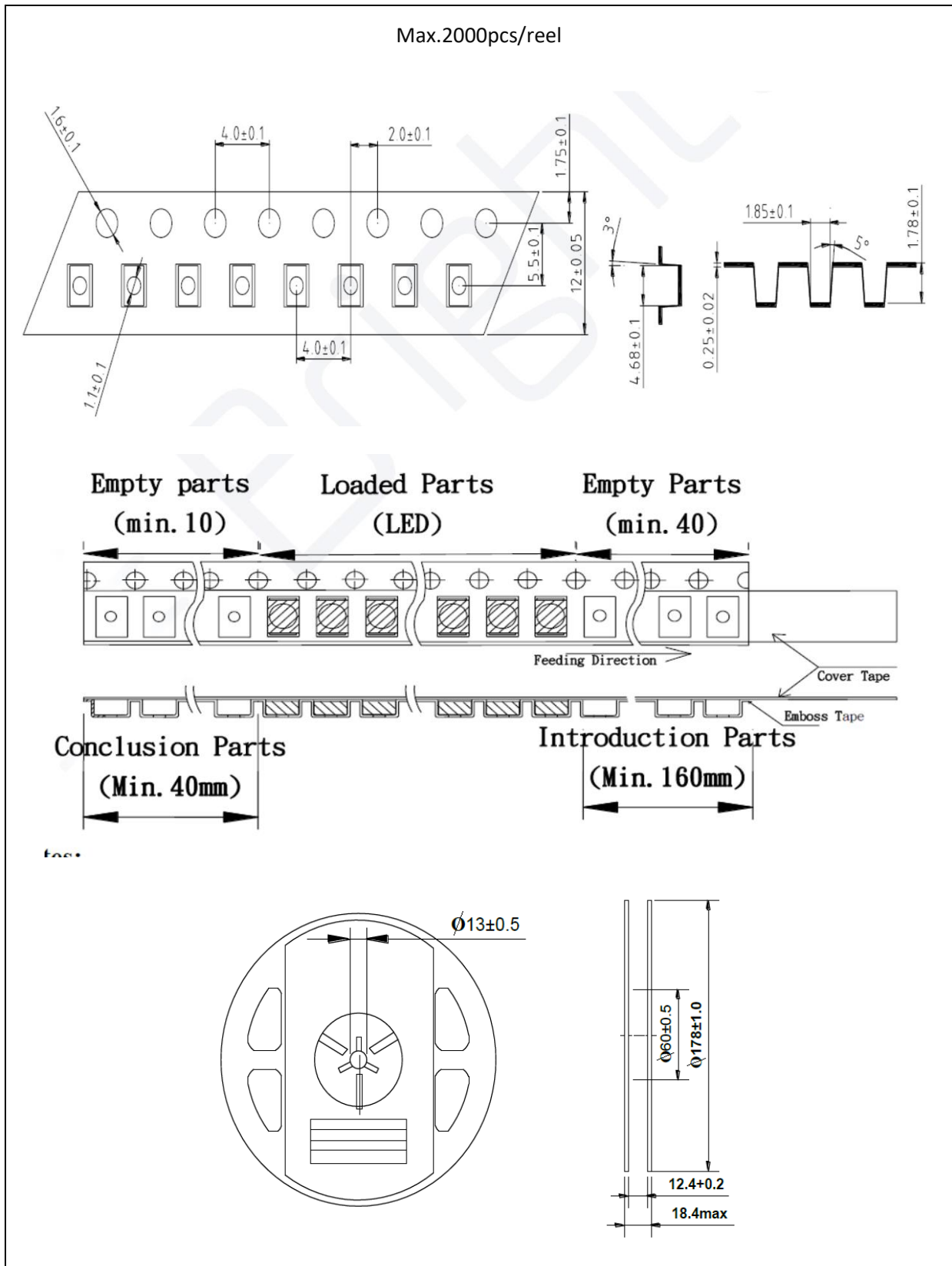

PRECAUTIONS OF USE:

Storage:

It is recommended to store the products in the following conditions:

- Humidity: 60% R.H. Max.
- Temperature: 5°C~30°C (41°F ~86°F).

Shelf life in sealed bag: 12 months at 5°C~30°C and <60% R.H.

Once the package is opened, the products should be used within a week. Otherwise, they should be kept in a damp-proof box with desiccating agent <10% R.H. and apply baking before use.

Baking:

It is recommended to bake the LED before soldering if the pack has been unsealed for longer than 24hrs. The suggested baking conditions are as followings:

- 60±3°C x 6hrs and <5%RH, taped / reel package.

It's normal to see slight color fading of carrier (light yellow) after baking in process.

Testing Circuit:

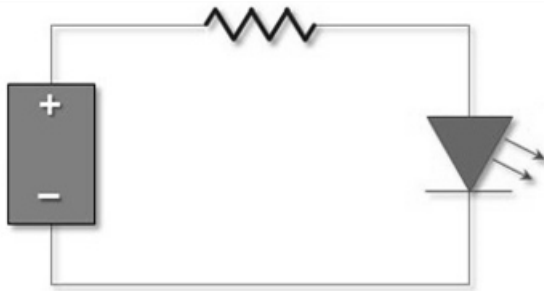

Must apply resistor(s) for protection (over current proof).

Cleaning:

Use alcohol-based cleaning solvents such as isopropyl alcohol to clean the LED carrier / package. Avoid putting any stress force directly on to the LED lens.

ESD (Electrostatic Discharge):

Static Electricity or power surge will damage the LED. Use of a conductive wrist band or anti-electrostatic glove is recommended when handling the LED all time. All devices, equipment, machinery, work tables, and storage racks must be properly grounded.

In the events of manual working in process, make sure the devices are well protected from ESD at any time.

REVISION RECORD:

Version	Date	Summary of Revision
A1.0	28/11/2022	Datasheet set-up.