



**BRIGHTTEK**  
**BRIGHTTEK (EUROPE) LIMITED**

*Brighten Up The World With LED!*



ISO/TS 16949:2009



BS EN ISO 14001:2004



QC 080000 IECQ HSPM

## PRODUCT DATASHEET



- ▶ Ceramic High Power
- ▶ 3535 3.6t Series
- ▶ True Green (520nm)

**NOG56S81Z**



Release Date: 06 July 2021 Version: A1.0

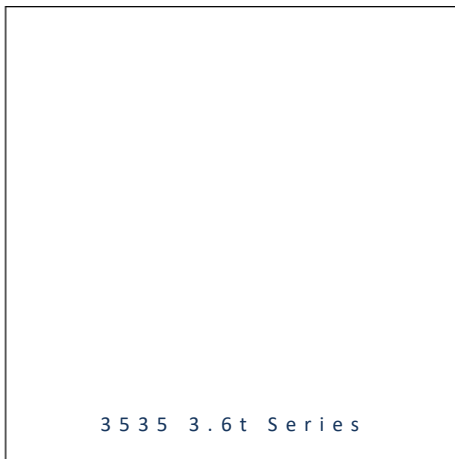

3535 3.6t Series

### 3535 3.6t Series



**RoHS  
Compliant**

#### FEATURES:

- **Package:** Ceramic SMT Package with Silicon Lens
- **Forward Current:** 350~700mA
- **Forward Voltage (typ.):** 3.2V
- **Luminous Flux (typ.):** 100lm@350mA
- **Colour:** True Green
- **Wavelength:** 515~530nm
- **Viewing angle:** 30°
- **Materials:**
  - Resin: Silicon (Water Clear)
  - L/T Finish: Ag plated
- **Operating Temperature:** -40~+85°C
- **Storage Temperature:** -40~+100°C
- **Grouping parameters:**
  - Forward Voltage
  - Luminous Flux
  - Dominant Wavelength
- **Soldering methods:** Reflow Soldering
- **Preconditioning:** MSL4 according to J-STD020
- **Packing:** 12mm tape with max.500pcs/reel, ø180mm (7")

#### APPLICATIONS:

- Portable Lighting
- Outdoor Lighting
- Commercial Lighting
- Indoor Lighting
- Industrial Lighting
- Plant Grow Light

## CHARACTERISTICS:

### Absolute Maximum Characteristics (Ta=25°C)

Parameter	Symbol	Ratings	Unit
DC Forward Current	I <sub>F</sub>	700	mA
Pulse Forward Current	I <sub>PF</sub>	1000	mA
Reverse Voltage	V <sub>R</sub>	5	V
Reverse Current @5V	I <sub>R</sub>	10	μA
Junction Temperature	T <sub>J</sub>	115	°C
Operating Temperature	T <sub>OPR</sub>	-40~+85	°C
Storage Temperature	T <sub>STG</sub>	-40~+100	°C
Soldering Temperature	T <sub>SOL</sub>	260	°C
Thermal Resistance - Junction to Solder Point	R <sub>th</sub>	7	°C/W

\* in the order of Cool White / Warm White

### Electrical & Optical Characteristics (Ta=25°C)

Parameter	Symbol	Values			Unit	Test Condition
		Min.	Typ.	Max.		
Forward Voltage	V <sub>F</sub>	2.8	---	3.6	V	I <sub>F</sub> =350mA
Luminous Flux	Φ <sub>V</sub>	90	---	110	lm	I <sub>F</sub> =350mA
Dominant Wavelength	λ <sub>D</sub>	515	---	530	nm	I <sub>F</sub> =350mA
Viewing Angle	2θ <sub>1/2</sub>	---	30	---	deg	I <sub>F</sub> =350mA

1. Radiant Flux (Φ<sub>V</sub>) ±5%, Forward Voltage (V<sub>F</sub>) ±0.06V, Viewing angle(2θ<sub>1/2</sub>) ±10°

## OUTLINE DIMENSION:

Package Dimension:

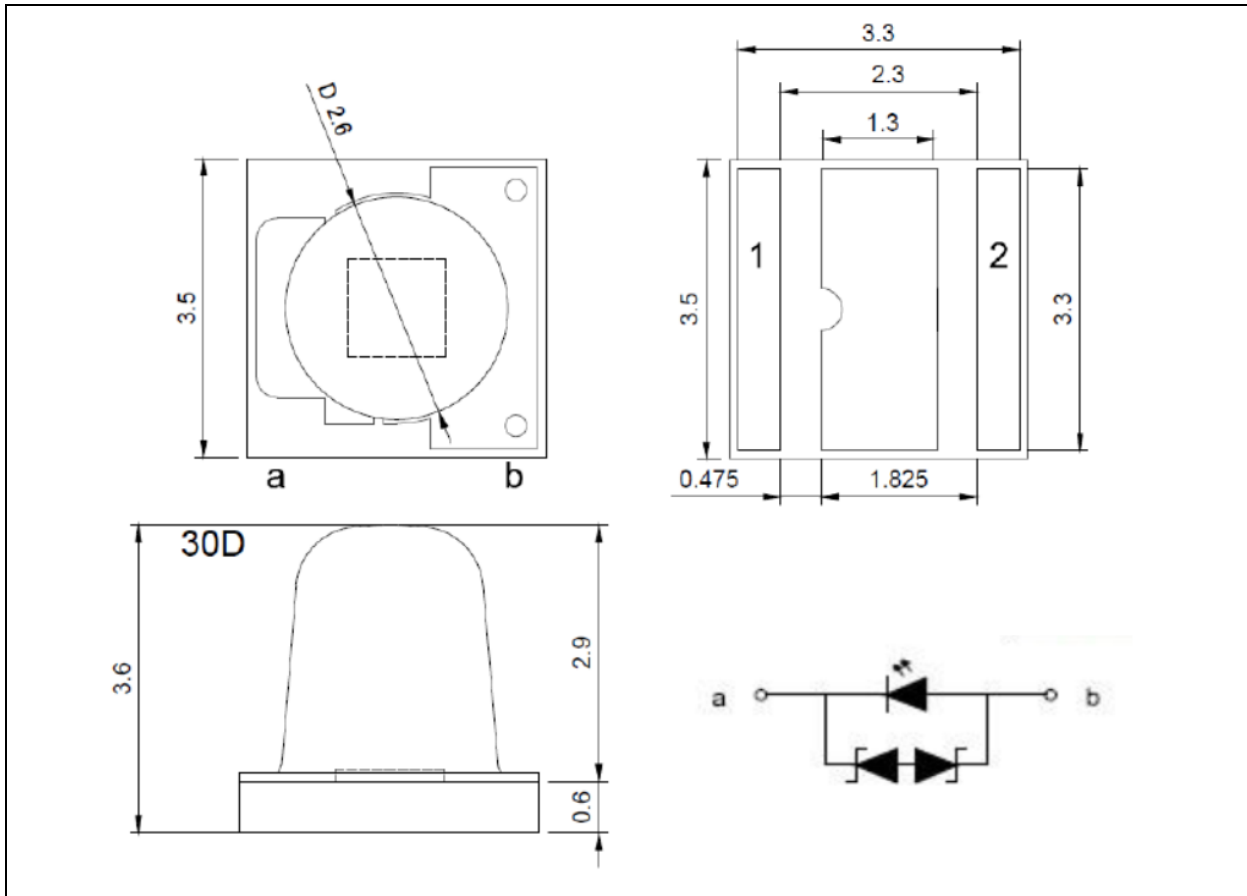

1. All dimensions are in millimetre (mm).
2. Tolerance  $\pm 0.13$ mm, unless otherwise noted.

Recommended Soldering Pad Dimension:

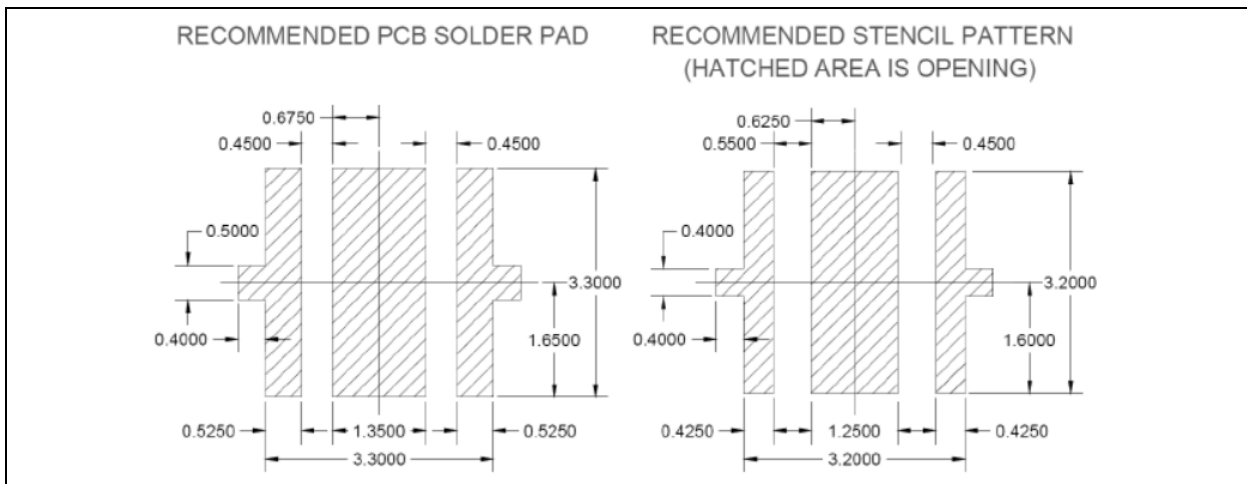

1. Dimensions are in millimetre (mm).
2. Tolerance  $\pm 0.12$ mm with angle tolerance  $\pm 0.5^\circ$ .

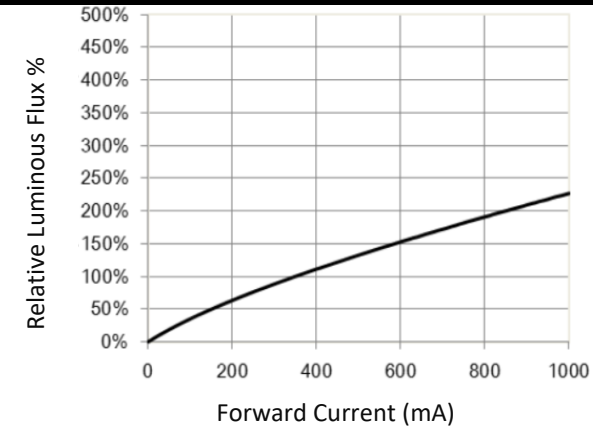
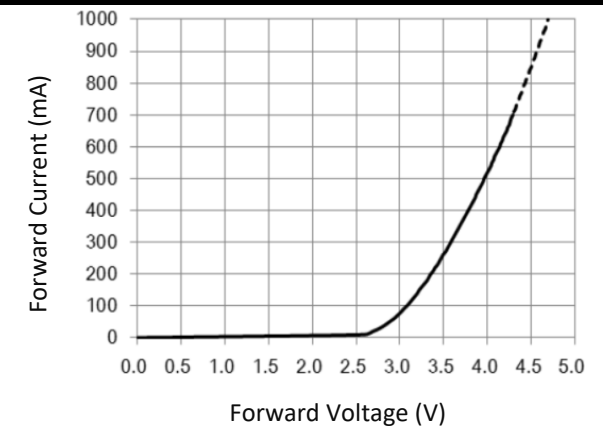
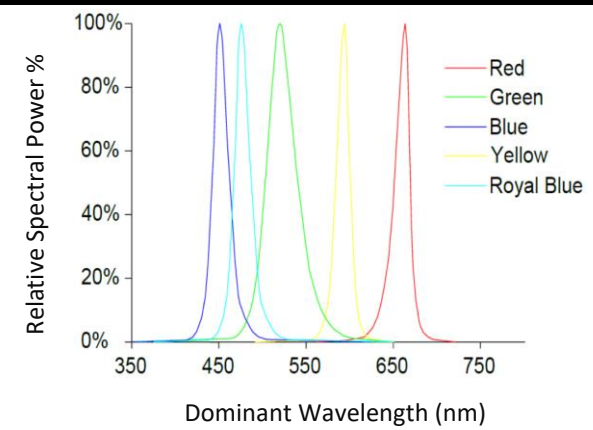
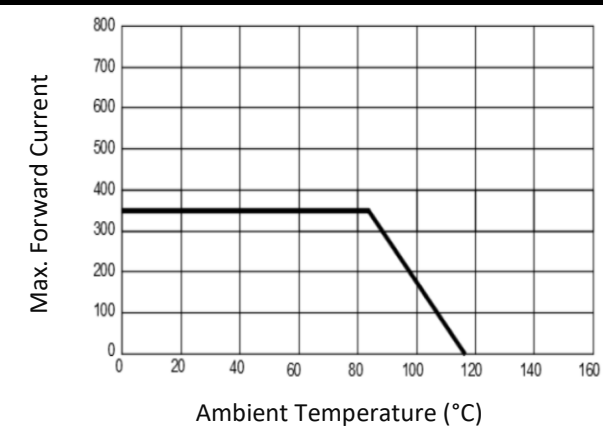
**ELECTRO-OPTICAL CHARACTERISTICS:**
**Relative Luminous Flux v.s. Forward Current**

**Forward Current v.s. Forward Voltage**

**Relative Spectral Power v.s. Wavelength**

**Max. Current v.s. Ambient Temperature**

**BINNING GROUPS:**

---

 Forward Voltage Classifications ( $I_F = 350\text{mA}$ ):

Code	Min.	Max.	Unit
V28	2.8	3.0	V
V30	3.0	3.2	
V32	3.2	3.4	
V34	3.4	3.6	

 Luminous Flux Classifications ( $I_F = 350\text{mA}$ ):

Code	Min.	Max.	Unit
G80	80	90	lm
G90	90	100	
GH1	100	110	

 Dominant Wavelength Classifications ( $I_F = 350\text{mA}$ ):

Code	Min.	Max.	Unit
G1	515	520	nm
G2	520	525	
G3	525	530	

## RECOMMENDED SOLDERING PROFILE:

### Reflow Lead-free Solder:

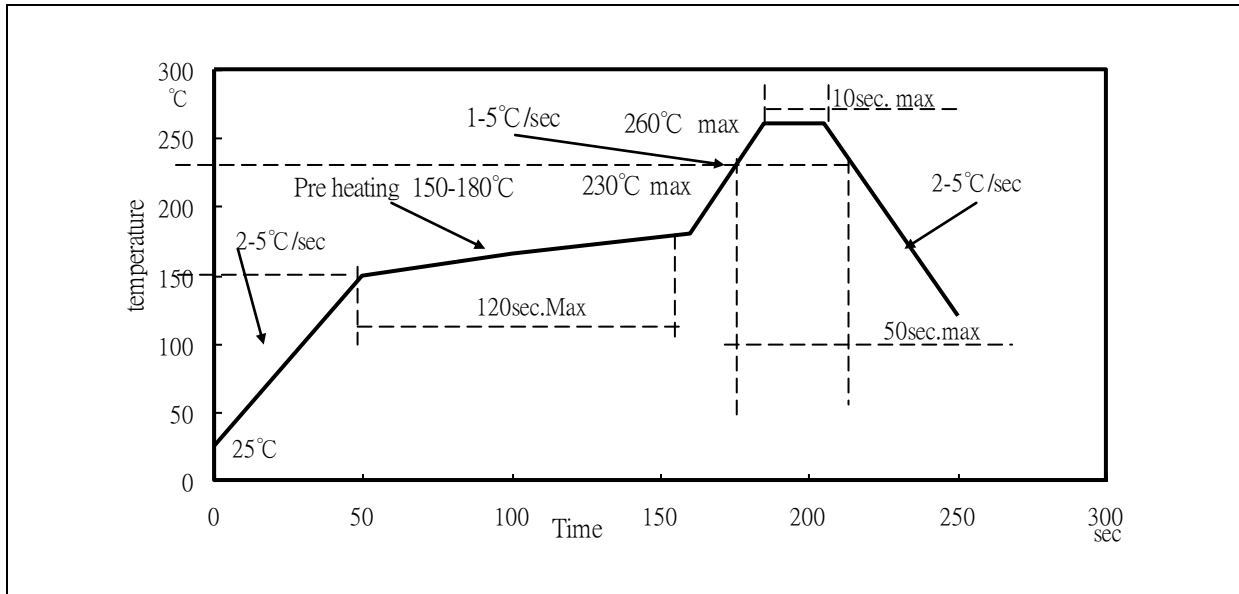

### Note:

1. Maxima reflow soldering: 3 times.
2. The recommend reflow temperature is 240°C. The maxima soldering temperature should be limited to 260°C.
3. Before, during, and after soldering, should not apply stress on the components and PCB board.



## PRECAUTIONS OF USE:

---

### Storage:

It is recommended to store the products in the following conditions:

- Humidity: 60% R.H. Max.
- Temperature: 5°C~30°C (41°F ~86°F).

Shelf life in sealed bag: 12 months at 5°C~30°C and <60% R.H.

Once the package is opened, the products should be used within a week. Otherwise, they should be kept in a damp-proof box with desiccating agent <10% R.H. and apply baking before use.

### Baking:

It is recommended to bake the LED before soldering if the pack has been unsealed for longer than 24hrs. The suggested baking conditions are as followings:

- 60±3°C x 24hrs and <5%RH, taped / reel package.

It's normal to see slight color fading of carrier (light yellow) after baking in process.

### Testing Circuit:

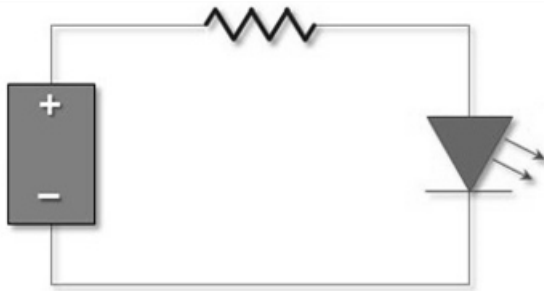

Must apply resistor(s) for protection (over current proof).

### Cleaning:

Use alcohol-based cleaning solvents such as isopropyl alcohol to clean the LED carrier / package. Avoid putting any stress force directly on to the LED lens.

### ESD (Electrostatic Discharge):

Static Electricity or power surge will damage the LED. Use of a conductive wrist band or anti-electrostatic glove is recommended when handling the LED all time. All devices, equipment, machinery, work tables, and storage racks must be properly grounded.

In the events of manual working in process, make sure the devices are well protected from ESD at any time.



**REVISION RECORD:**

---

Version	Date	Summary of Revision
A1.0	06/07/2021	Datasheet set-up.