



BRIGHTTEK
BRIGHTTEK (EUROPE) LIMITED

Brighten up The World With LED!



ISO/TS 16949:2009



BS EN ISO 14001:2004



QC 080000 IECQ HSPM

PRODUCT DATASHEET



- ▶ Subminiature SMD
- ▶ 2421 Series
- ▶ Green (525nm)

NOG12S26



Release Date: 07 August 2014 Version: A1.0



2421 Series



FEATURES:

- **Package:** Subminiature SMD
- **Forward Current:** 20mA
- **Forward Voltage (typ.):** 3.2V
- **Luminous Intensity (typ.):** 10000mcd @20mA
- **Colour:** Green
- **Wavelength:** 525nm
- **Viewing angle:** 20°
- **Materials:**
 - Die: InGaN
 - Resin: Epoxy (Water Clear)
- **Operating Temperature:** -40~+80°C
- **Storage Temperature:** -40~+85°C
- **Grouping parameters:**
 - Forward voltage
 - Luminous intensity
 - Dominant wavelength
- **Soldering methods:** Reflow
- **Preconditioning:** acc. to JEDEC Level 3
- **Packing:** 16mm tape with 1000/reel, ø180mm (7")

APPLICATIONS:

- Backlighting
- Indication Light
- Switch light
- Dashboard

CHARACTERISTICS:

Absolute Maximum Characteristics (Ta=25°C)

Parameter	Symbol	Ratings	Unit
Forward Current	I_F	30	mA
Peak Forward Current Duty 1/8@1KHz	I_{FP}	125	mA
Reverse Current @5V	I_R	10	μ A
Power Dissipation	P_D	111	mW
Operating Temperature	T_{OPR}	-40~+80	°C
Storage Temperature	T_{STG}	-40~+85	°C

Electrical & Optical Characteristics (Ta=25°C)

Parameter	Symbol	Values			Unit	Test Condition
		Min.	Typ.	Max.		
Forward Voltage	V_F	2.8	3.2	3.7	V	$I_F=20mA$
Luminous Intensity	I_V	5200	10000	18000	mcd	$I_F=20mA$
Dominant Wavelength	λ_D	520	525	530	nm	$I_F=20mA$
Peak Wavelength	λ_P	---	520	---	nm	$I_F=20mA$
Spectral Line Half Bandwidth	$\Delta \lambda$	---	32	---	nm	$I_F=20mA$
Viewing Angle	$2\theta_{1/2}$	---	20	---	deg	$I_F=20mA$

1. Luminous intensity (I_V) $\pm 15\%$, Forward Voltage (V_F) $\pm 0.1V$, Viewing angle($2\theta_{1/2}$) $\pm 5\%$
2. IS standard testing

OUTLINE DIMENSION:

Package Dimension:

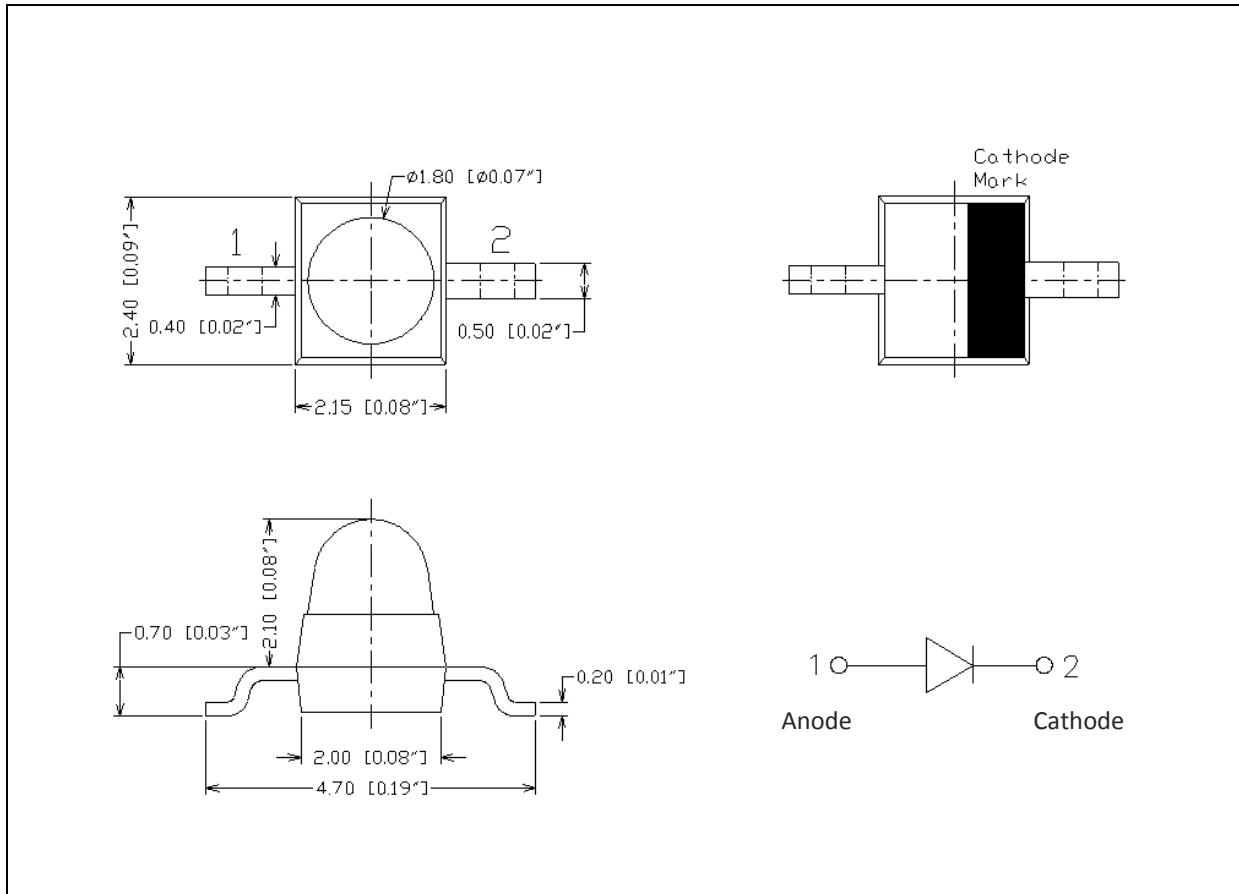

1. All dimensions are in millimetre (mm).
2. Tolerance $\pm 0.2\text{mm}$, unless otherwise noted.

Recommended Soldering Pad Dimension:

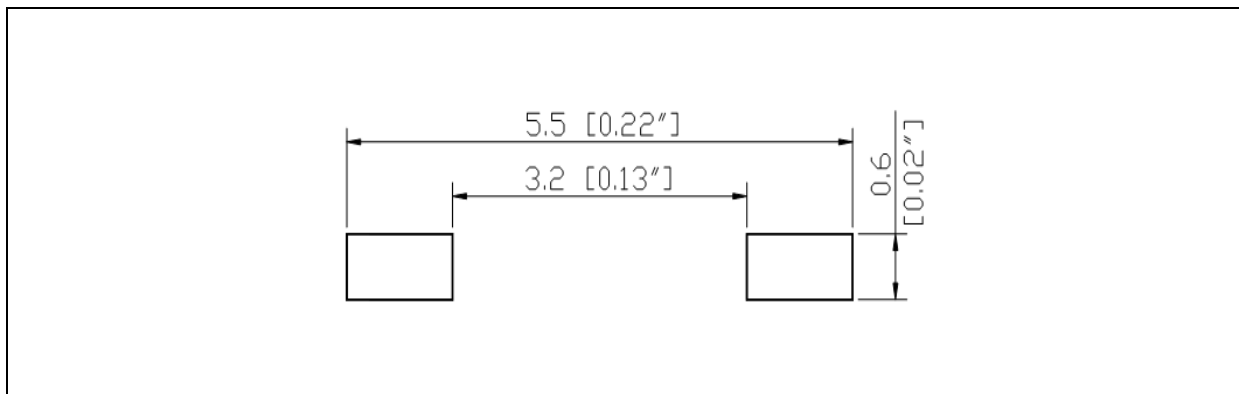

1. Dimensions are in millimetre (mm).
2. Tolerance $\pm 0.1\text{mm}$ with angle tolerance $\pm 0.5^\circ$.

BINNING GROUPS:

 Forward Voltage Classifications ($I_F = 20\text{mA}$):

Code	Min.	Max.	Unit
F	2.8	3.1	V
G	3.1	3.4	
H	3.4	3.7	

 Luminous Intensity Classifications ($I_F = 20\text{mA}$):

Code	Min.	Max.	Unit
P	5200	8000	mcd
Q	8000	10000	
R	10000	14000	
S	14000	18000	

 Dominant Wavelength Classifications ($I_F = 20\text{mA}$):

Code	Min.	Max.	Unit
U	520	522.5	nm
V	522.5	525	
W	525	527.5	
X	527.5	530	

ELECTRO-OPTICAL CHARACTERISTICS:

Relative Spectral Distribution

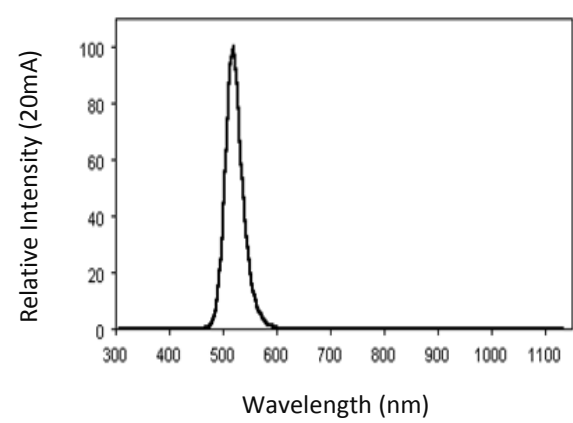

Forward Current v.s. Forward Voltage

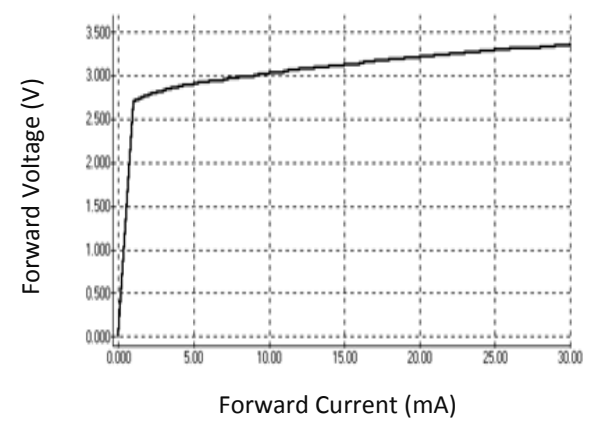

Directive Radiation

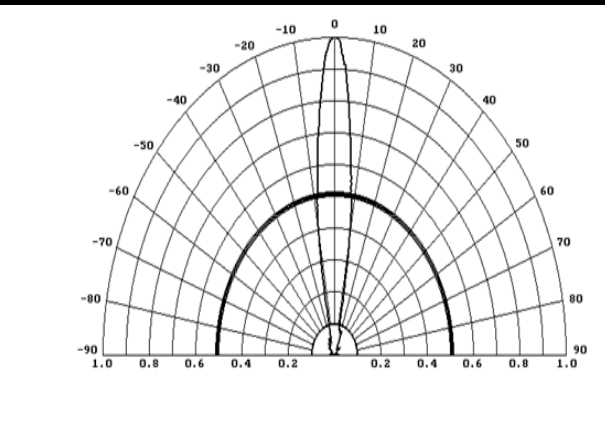

RECOMMENDED SOLDERING PROFILE:

Reflow Solder:

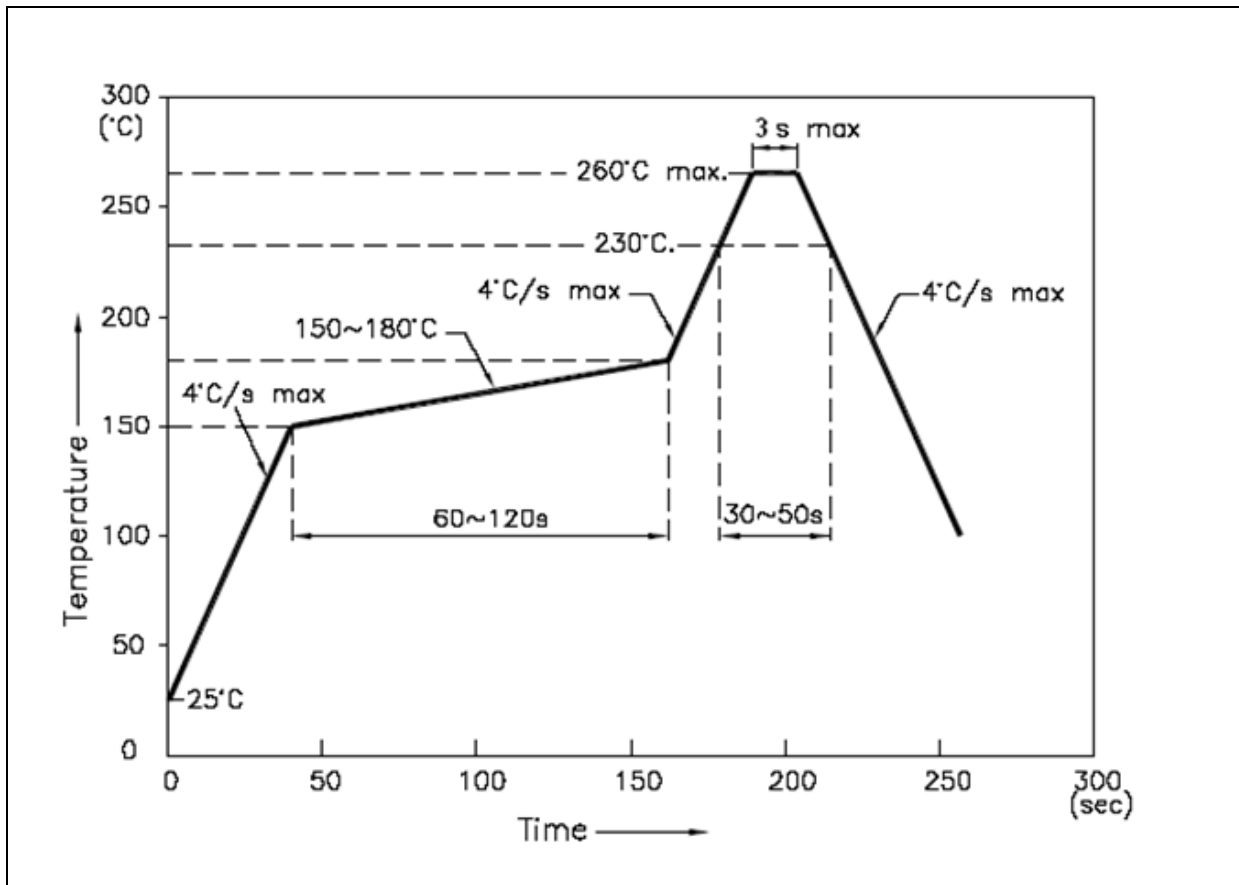

Note:

1. Recommend reflow temperature 245°C.
2. Maximum reflow soldering: 2 times.
3. Before, during, and after soldering, should not apply stress on the components and PCB board.



PACKING SPECIFICATION:

Reel Dimension:

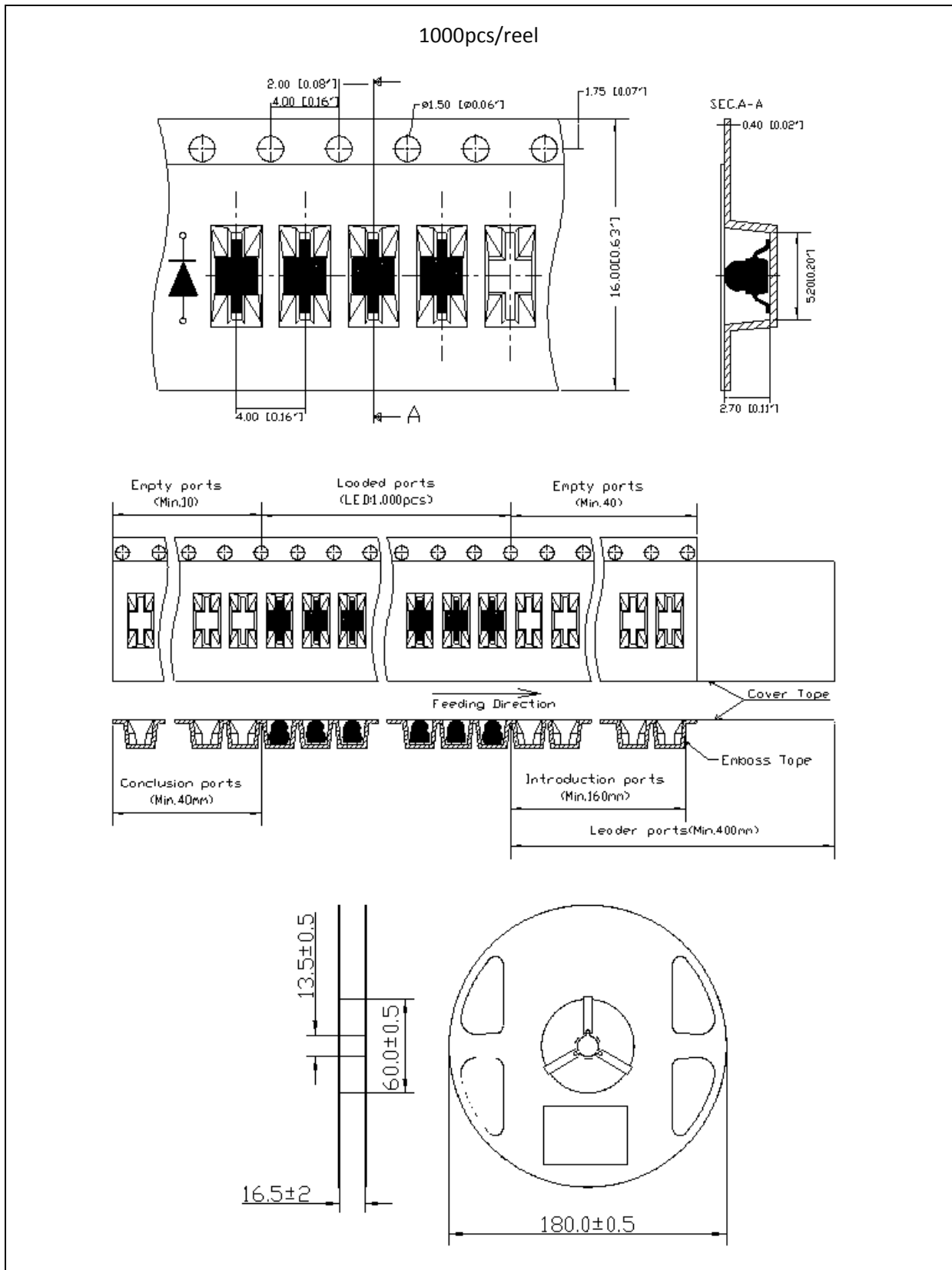

PRECAUTIONS OF USE:

Storage:

It is recommended to store the products in the following conditions:

- Humidity: 60% R.H. Max.
- Temperature: 5°C~30°C (41°F ~86°F).

Shelf life in sealed bag: 12 month at 5°C~30°C and <60% R.H.

Once the package is opened, the products should be used within a week. Otherwise, they should be kept in a damp-proof box with desiccating agent and apply baking at 60°C±5°C for 15hrs before use.

Baking:

It is recommended to bake the LED before soldering if the pack has been unsealed for longer than 24hrs.

The suggested baking conditions are as follows:

- 70±3°C x 24hrs and <5%RH, taped / reel package.
- 100±3°C x 2hrs, bulk (loose) package.
- 130±3°C x 30min, bulk (loose) package.

It's normal to see slight color fading of carrier (light yellow) after baking in process.

Testing Circuit:



Must apply resistor(s) for protection (over current proof).

Cleaning:

Use alcohol-based cleaning solvents such as isopropyl alcohol to clean the LED carrier / package. Avoid putting any stress force directly on to the LED lens.

ESD (Electrostatic Discharge):

Static Electricity or power surge will damage the LED. Use of a conductive wrist band or anti-electrostatic glove is recommended when handling the LED all time. All devices, equipment, machinery, work tables, and storage racks must be properly grounded.

In the events of manual working in process, make sure the devices are well protected from ESD at any time.

REVISION RECORD:

Version	Date	Summary of Revision
A1.0	07/08/2014	Datasheet set-up.