



BRIGHTTEK
BRIGHTTEK (EUROPE) LIMITED

Brighten up The World With LED!



ISO/TS 16949:2009



BS EN ISO 14001:2004



QC 080000 IECQ HSPM

PRODUCT DATASHEET



- ▶ PTH/THT Lamp
- ▶ 5mm Round 8.7t
- ▶ Green (572nm)

NOG02L47 (Bulk)
NOG02L47T (Tape)



Release Date: 13 December 2023 Version: A1.3



5 m m R o u n d L a m p

5mm Round Lamp

RoHS
Compliant



FEATURES:

- **Package:** PTH/THT LED Lamp 5mm Round 8.7t
- **Forward Current:** 20mA
- **Forward Voltage (typ.):** 2.0V
- **Luminous Intensity (typ.):** 260mcd@20mA
- **Colour:** Green
- **Dominant Wavelength (typ.):** 572nm
- **Viewing Angle:** 45°
- **Materials:**
 - Die: AlInGaP
 - Resin: Epoxy (Green Diffused)
- **Operating Temperature:** -40~+85°C
- **Storage Temperature:** -40~+100°C
- **Grouping Parameters:**
 - Forward voltage
 - Luminous intensity
 - Dominant wavelength
- **Soldering Methods:** Hand; Soldering Heat (DIP)
- **Packing:** 500pcs/bulk; 2000pcs/tape (Ammo Pack)

APPLICATIONS:

- Indicator
- Signal
- 3C Application

CHARACTERISTICS:

Absolute Maximum Characteristics (Ta=25°C)

Parameter	Symbol	Ratings	Unit
Forward Current	I _F	30	mA
Peak Forward Current Duty 1/10@1KHz	I _{FP}	100	mA
Reverse Current @5V	I _R	10	μA
Reverse Voltage	V _R	5	V
Power Dissipation	PD	85	mW
Electrostatic Discharge	ESD	2000	V
Operating Temperature	T _{OPR}	-40~+85	°C
Storage Temperature	T _{STG}	-40~+100	°C

Electrical & Optical Characteristics (Ta=25°C)

Parameter	Symbol	Values			Unit	Test Condition
		Min.	Typ.	Max.		
Forward Voltage	V _F	1.9	2.0	2.4	V	I _F =20mA
Luminous Intensity	I _v	150	260	350	mcd	I _F =20mA
Dominant Wavelength	λ _D	568	572	575	nm	I _F =20mA
Peak Wavelength	λ _P	---	570	---	nm	I _F =20mA
Spectral Line Half Bandwidth	Δλ	---	15	---	nm	I _F =20mA
Viewing Angle	2θ _{1/2}	---	45	---	deg	I _F =20mA

1. Luminous intensity (I_v) ±15%, Forward Voltage (V_F) ±0.1V, Viewing angle(2θ_{1/2}) ±5%



OUTLINE DIMENSION:

Package Dimension:

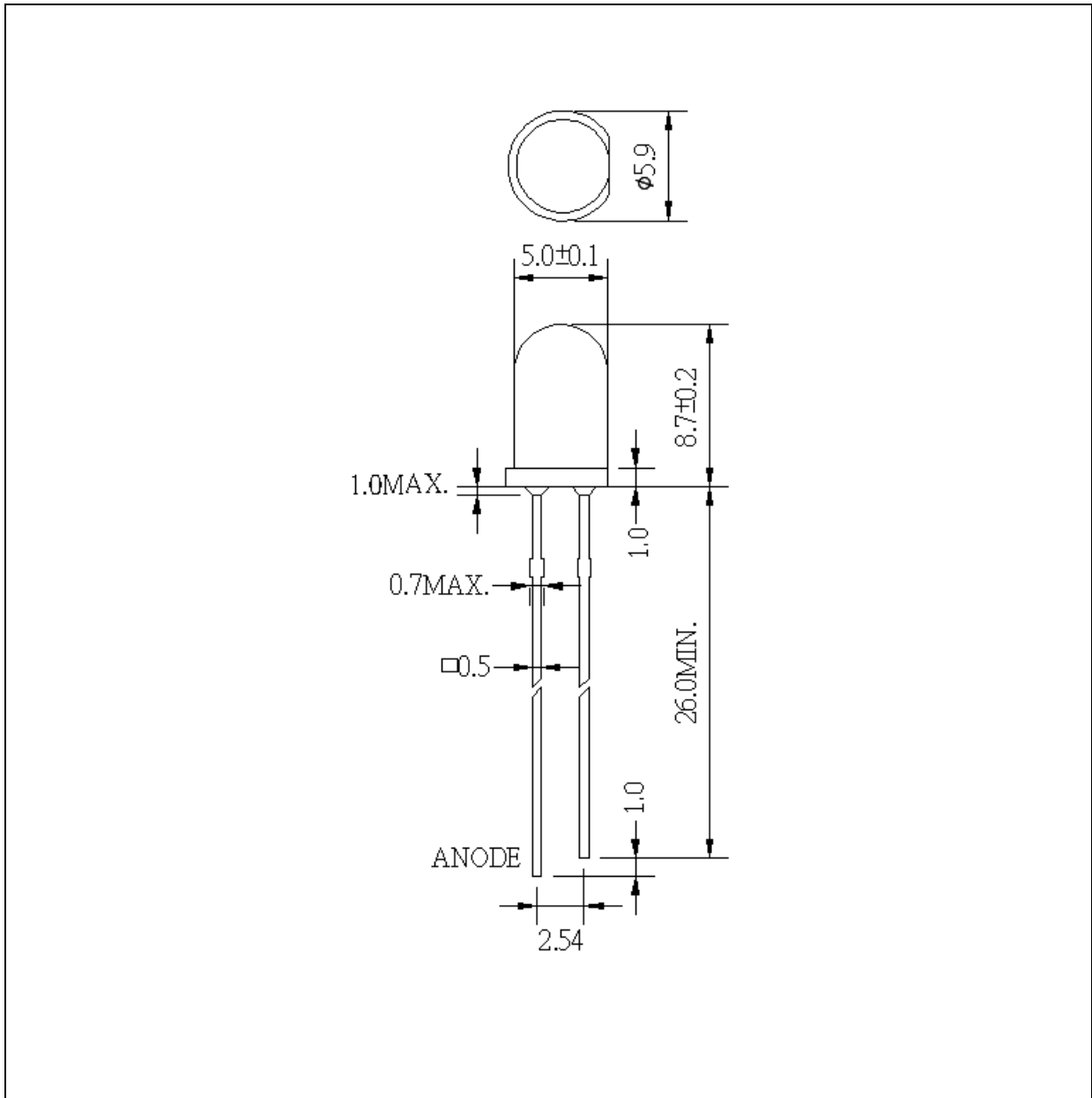

1. All dimensions are in millimetre (mm).
2. Tolerance ± 0.2 mm, unless otherwise noted.

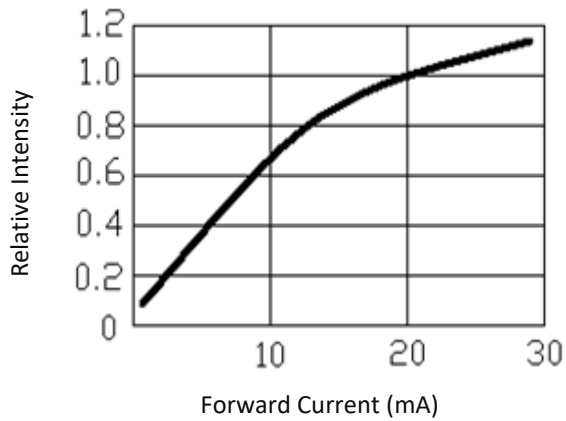
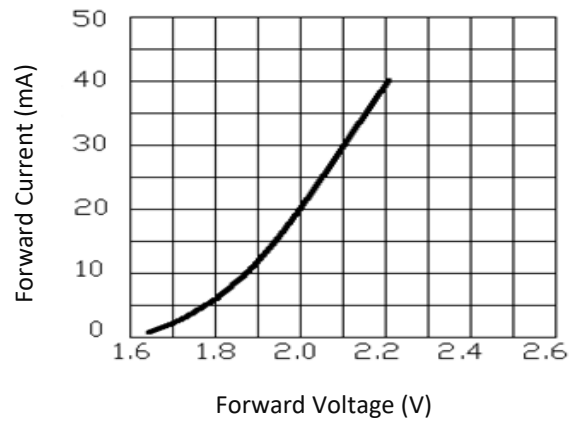
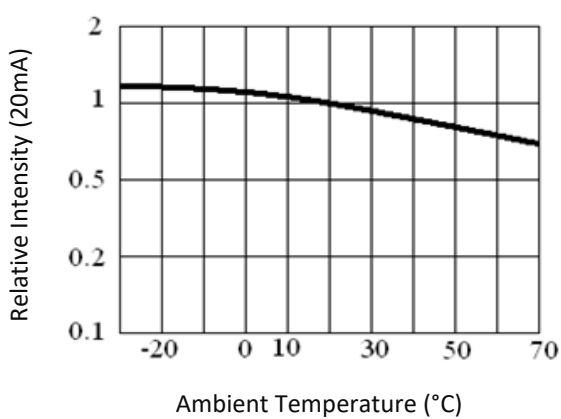
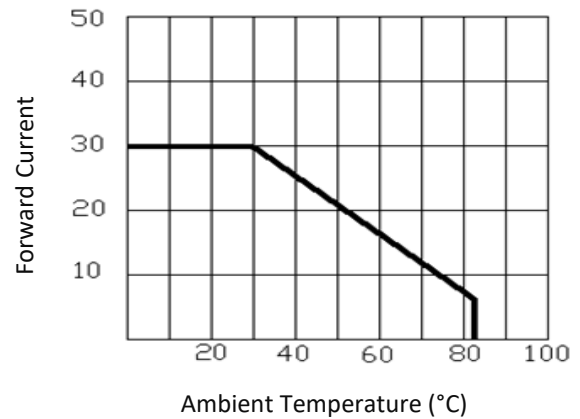
ELECTRO-OPTICAL CHARACTERISTICS:
Relative Intensity v.s. Forward Current

Forward Current v.s. Forward Voltage

Relative Intensity v.s. Temperature

Forward Current v.s. Temperature

RECOMMENDED SOLDERING PROFILE:

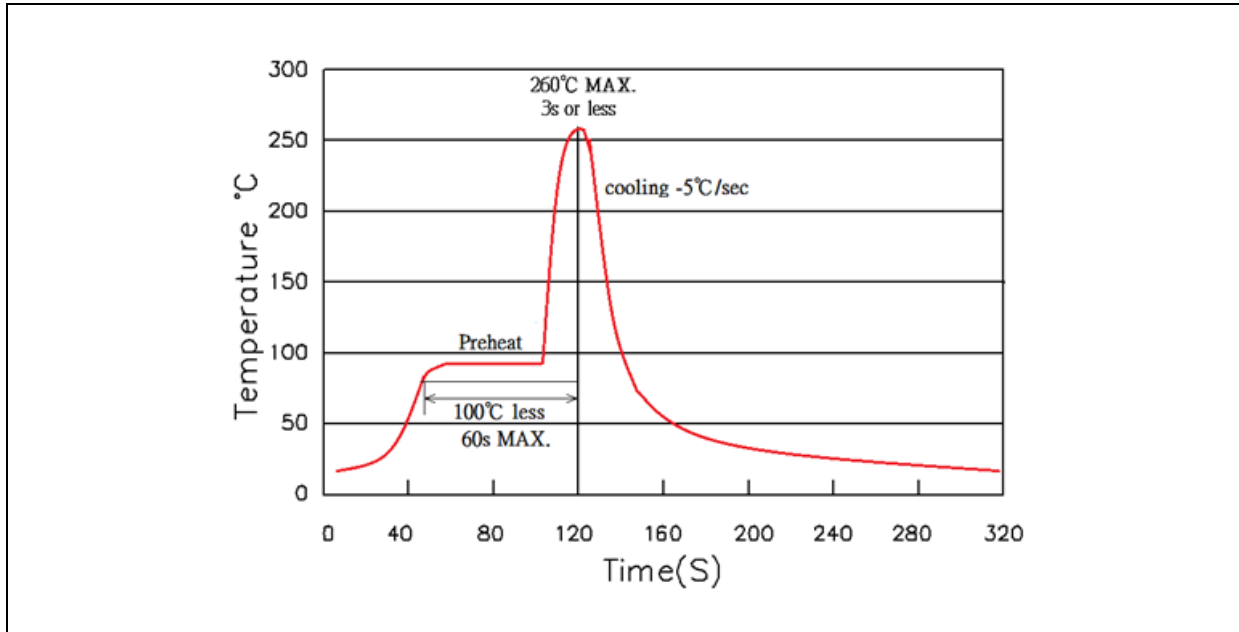
Hand Solder (Solder Iron):

- Temperature at tip of iron: 350°C Max. (25W Max.).
- Soldering Time: 3 seconds \pm 1 sec.

Soldering Heat (DIP):



Note:

1. Maximum reflow soldering: 1 time.
2. Before, during, and after soldering, should not apply stress on the components and PCB board.

PACKING SPECIFICATION:

Reel Dimension:

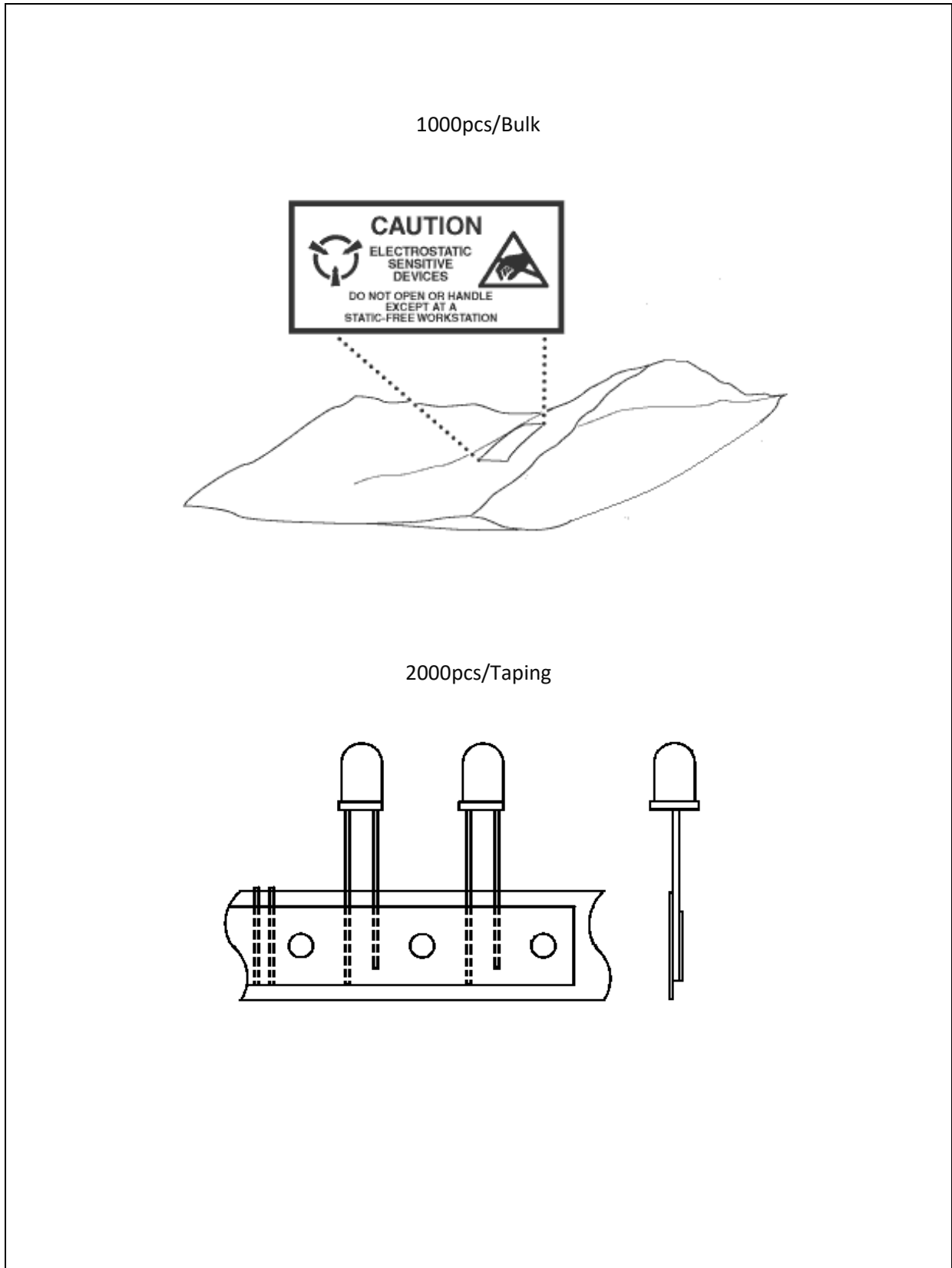

PRECAUTIONS OF USE:

Storage:

It is recommended to store the products in the following conditions:

- Humidity: 60% R.H. Max.
- Temperature: 5°C~30°C (41°F ~86°F).

Shelf life in sealed bag: 12 months at 5°C~30°C and <60% R.H.

Once the package is opened, the products should be used within a year. Otherwise, they should be kept in a damp-proof box with desiccating agent <10% R.H. and apply baking before use.

Baking:

It is recommended to bake the LED before soldering if the pack has been unsealed for longer than 24hrs. The suggested baking conditions are as followings:

- 60±5°C x 24hrs and <5%RH, taped / reel package.

It's normal to see slight color fading of carrier (light yellow) after baking in process.

Testing Circuit:

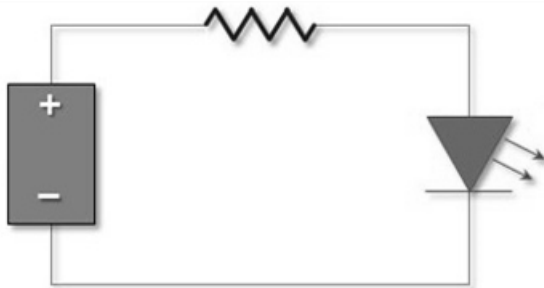

Must apply resistor(s) for protection (over current proof).

Cleaning:

Use alcohol-based cleaning solvents such as isopropyl alcohol to clean the LED carrier / package. Avoid putting any stress force directly on to the LED lens.

ESD (Electrostatic Discharge):

Static Electricity or power surge will damage the LED. Use of a conductive wrist band or anti-electrostatic glove is recommended when handling the LED all time. All devices, equipment, machinery, work tables, and storage racks must be properly grounded.

In the events of manual working in process, make sure the devices are well protected from ESD at any time.

REVISION RECORD:

Version	Date	Summary of Revision
A1.0	17/02/2023	Datasheet set-up.
A1.1	18/03/2023	Correct P4 title text.
A1.2	08/12/2023	Revise storage condition.
A1.3	13/12/2023	Add product photo.