



BRIGHTTEK
BRIGHTTEK (EUROPE) LIMITED

Brighten Up The World With LED!



ISO/TS 16949:2009



BS EN ISO 14001:2004



QC 080000 IECQ HSPM

PRODUCT DATASHEET



- ▶ PLCC4 SMD
- ▶ 3528 1.8t
- ▶ Blue (470nm)

NOB19S73



Release Date: 22 February 2018 Version: A1.1

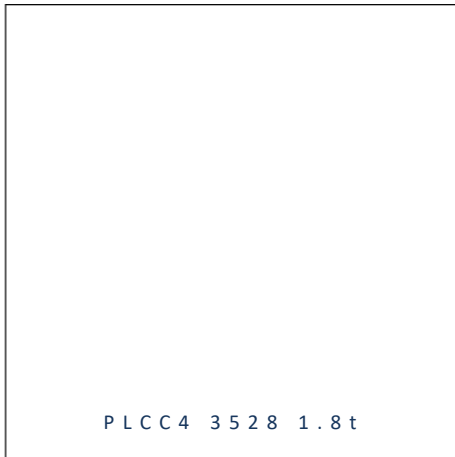

PLCC4 3528 1.8t

RoHS
Compliant



FEATURES:

- **Package:** PLCC4 Top View SMT White Package
- **Forward Current:** 50mA
- **Forward Voltage (typ.):** 3.4V
- **Luminous Intensity (typ.):** 585mcd@50mA
- **Colour:** Blue
- **Wavelength:** 470nm
- **Viewing angle:** 120°
- **Materials:**
 - Die: InGaN
 - Resin: Silicone (Water Clear)
 - L/F Finish: Ag Plated
- **Operating Temperature:** -40~+80°C
- **Storage Temperature:** -40~+85°C
- **Grouping parameters:**
 - Forward voltage
 - Luminous intensity
 - Dominant Wavelength
- **Soldering methods:** Reflow soldering
- **Preconditioning:** acc. to JEDEC Level 3
- **Packing:** 8mm tape with Max.2000pcs/reel, ø180mm (7")

APPLICATIONS:

- LED Display
- Indicator
- Traffic Display
- Decoration Lighting

CHARACTERISTICS:

Absolute Maximum Characteristics (Ta=25°C)

Parameter	Symbol	Ratings	Unit
Forward Current	I _F	50	mA
Peak Forward Current Duty 1/8@1KHz	I _{FP}	125	mA
Reverse Voltage	V _R	5	V
Reverse Current @5V	I _R	10	μA
Power Dissipation	P _D	200	mW
Operating Temperature	T _{OPR}	-40~+80	°C
Storage Temperature	T _{STG}	-40~+85	°C

Electrical & Optical Characteristics (Ta=25°C)

Parameter	Symbol	Values			Unit	Test Condition
		Min.	Typ.	Max.		
Forward Voltage	V _F	2.8	3.4	4.0	V	I _F =50mA
Luminous Intensity	I _v	320	585	1000	mcd	I _F =50mA
Dominant Wavelength	λ _D	465	470	475	nm	I _F =50mA
Peak Wavelength	λ _P	---	465	---	nm	I _F =50mA
Spectral Half Bandwidth	Δλ	---	26	---	nm	I _F =50mA
Viewing Angle	2θ _{1/2}	---	120	---	deg	I _F =50mA

1. Luminous intensity (I_v) ±15%, Forward Voltage (V_F) ±0.1V

OUTLINE DIMENSION:

Package Dimension:

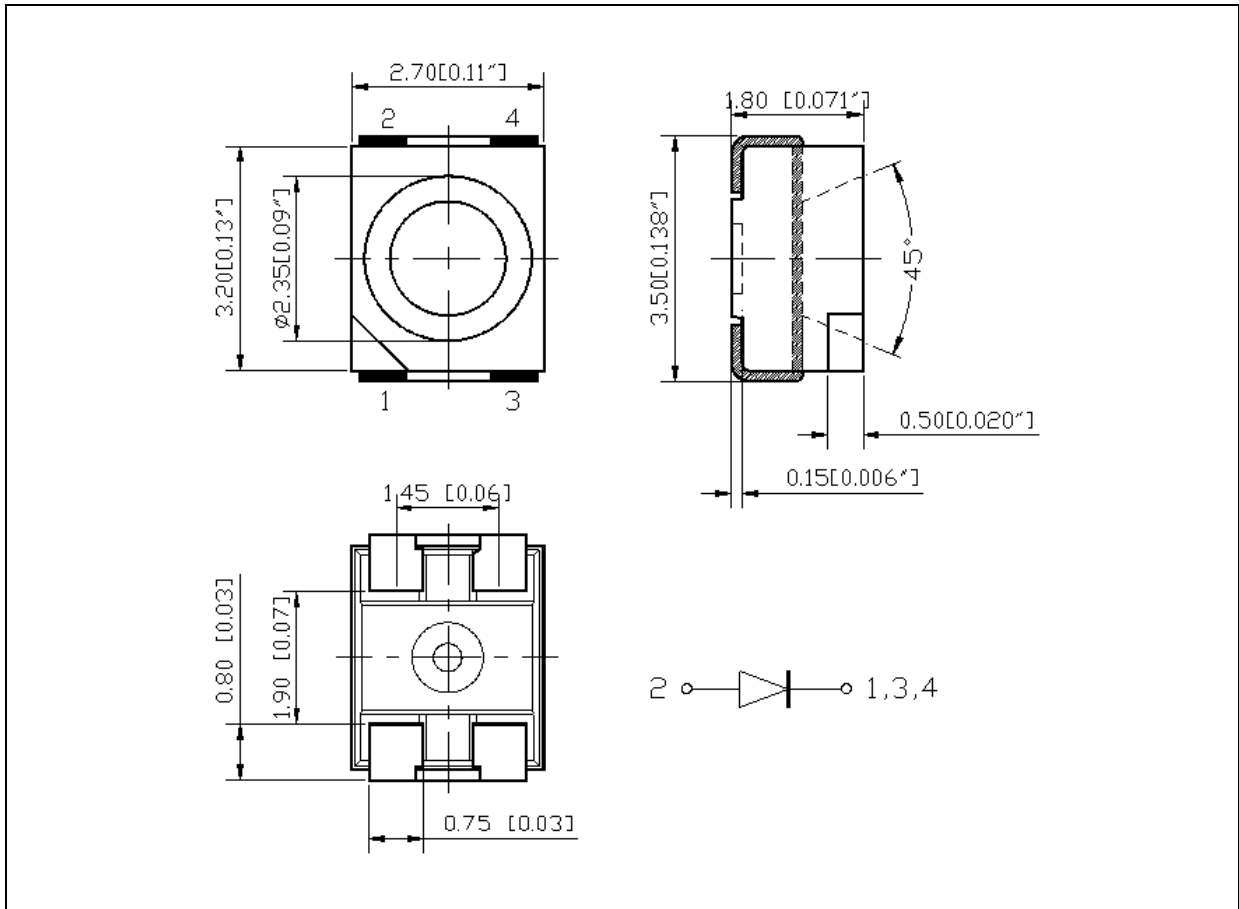

1. All dimensions are in millimetre (mm).
2. Tolerance ± 0.2 mm, unless otherwise noted.

Recommended Soldering Pad Dimension:

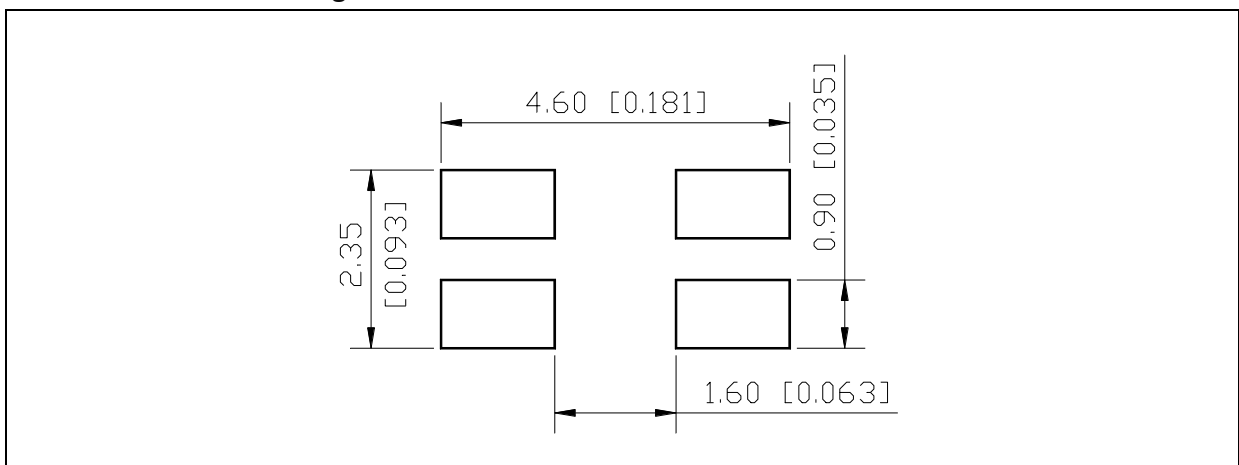

1. Dimensions are in millimetre (mm).
2. Tolerance ± 0.2 mm.

BINNING GROUPS:

 Forward Voltage Classifications ($I_F = 50\text{mA}$):

Code	Min.	Max.	Unit
F	2.8	3.1	V
G	3.1	3.4	
H	3.4	3.7	
I	3.7	4.0	

 Luminous Intensity Classifications ($I_F = 50\text{mA}$):

Code	Min.	Max.	Unit
O	320	400	mcd
P	400	500	
Q	500	630	
R	630	800	
S	800	1000	

 Wavelength Classifications ($I_F = 50\text{mA}$):

Code	Min.	Max.	Unit
G	465	467.5	nm
H	467.5	470	
I	470	472.5	
J	472.5	475	

ELECTRO-OPTICAL CHARACTERISTICS:

Relative Spectral Distribution

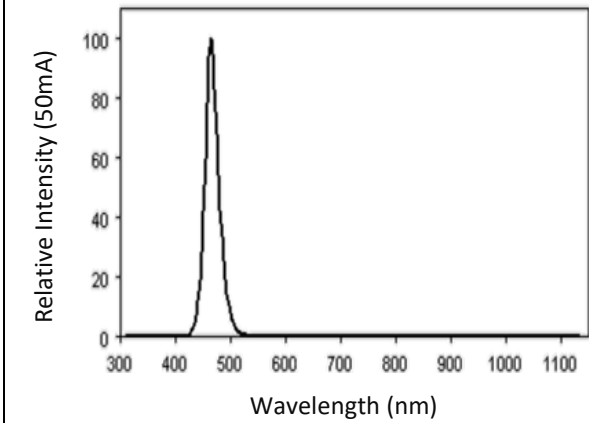

Forward Current v.s. Forward Voltage

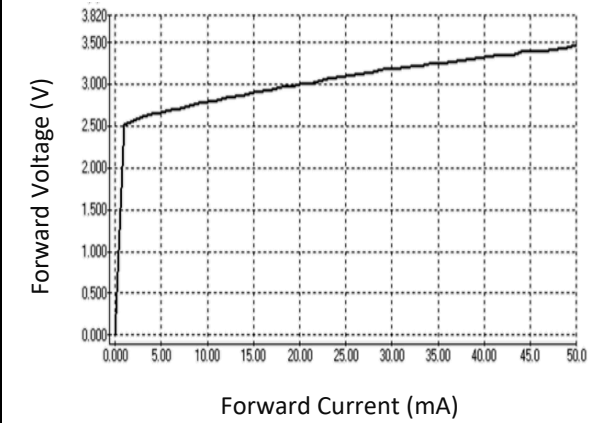

Directive Radiation

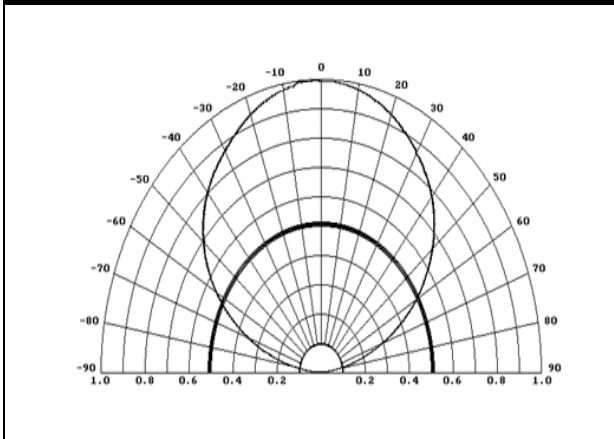

RECOMMENDED SOLDERING PROFILE:

Lead-free Solder:

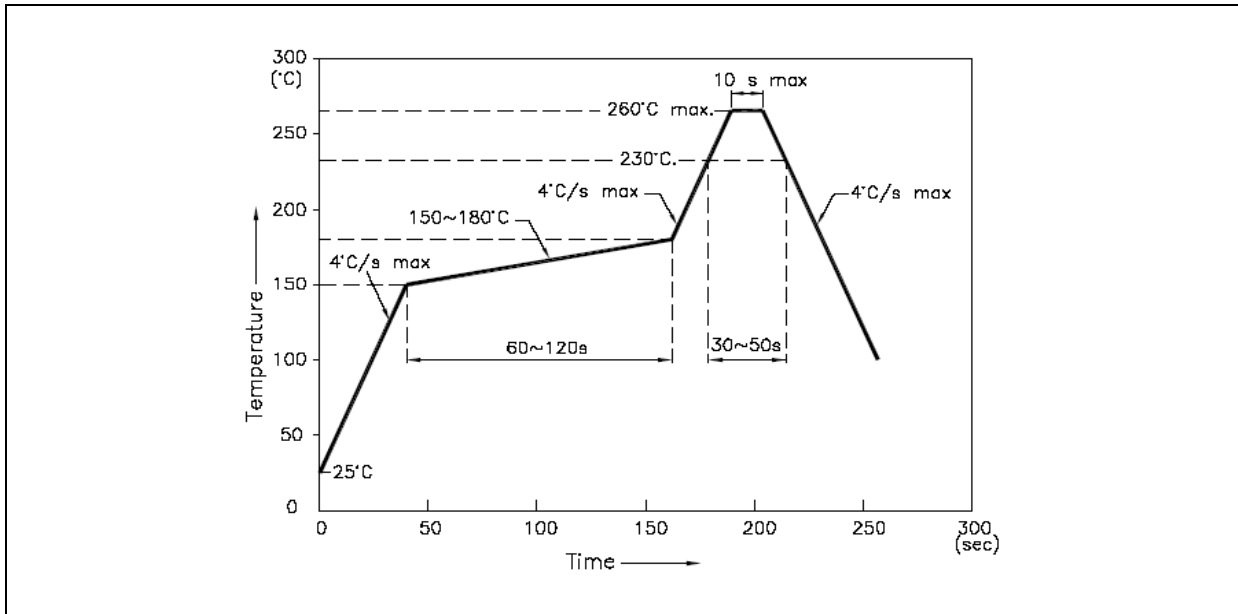

Note:

1. Maximum reflow soldering: 2 times.
2. The recommend soldering temperature is 245°C. The maximum soldering temperature should be limited to 260°C.
3. Before, during, and after soldering, should not apply stress on the components and PCB board.

PACKING SPECIFICATION:

Reel Dimension:

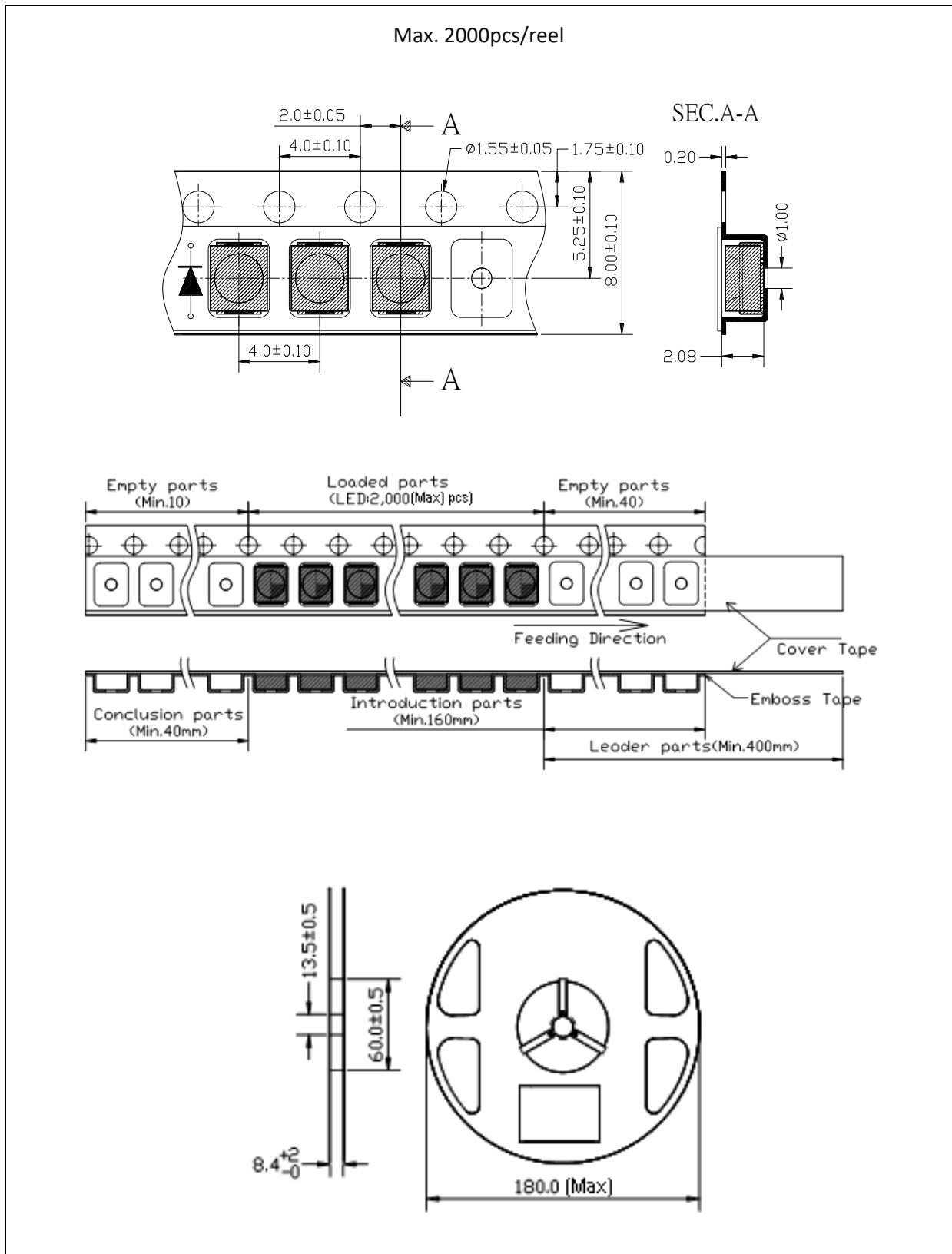

PRECAUTIONS OF USE:

Storage:

It is recommended to store the products in the following conditions:

- Humidity: 60% R.H. Max.
- Temperature: 5°C~30°C (41°F ~86°F).

Shelf life in sealed bag: 12 months at 5°C~30°C and <60% R.H.

Once the package is opened, the products should be used within a week. Otherwise, they should be kept in a damp-proof box with desiccating agent and apply baking at 60°C±5°C for 15hrs before use.

Baking:

It is recommended to bake the LED before soldering if the pack has been unsealed for longer than 24hrs. The suggested baking conditions are as followings:

- 60±3°C x 36hrs and <5%RH, taped / reel package.

It's normal to see slight color fading of carrier (light yellow) after baking in process.

Testing Circuit:

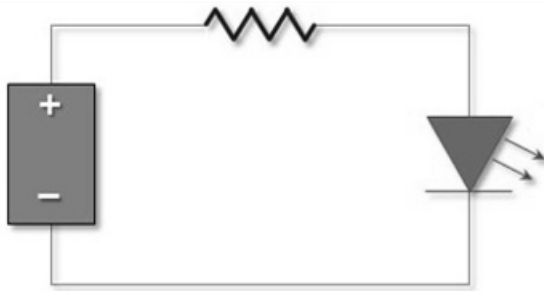

Must apply resistor(s) for protection (over current proof).

Cleaning:

Use alcohol-based cleaning solvents such as isopropyl alcohol to clean the LED carrier / package. Avoid putting any stress force directly on to the LED lens.

ESD (Electrostatic Discharge):

Static Electricity or power surge will damage the LED. Use of a conductive wrist band or anti-electrostatic glove is recommended when handling the LED all time. All devices, equipment, machinery, work tables, and storage racks must be properly grounded.

In the events of manual working in process, make sure the devices are well protected from ESD at any time.

REVISION RECORD:

Version	Date	Summary of Revision
A1.0	23/09/2015	Datasheet set-up.
A1.1	22/02/2018	New datasheet format.