

Photo DMOS-FET Relay

Description

The **LU634** is a miniature 1-Form B solid state relay in a 4 pin SMD package that employs optically coupled MOSFET technology to provide 3750V of input to output isolation. The optically coupled input is controlled by a highly efficient GaAlAs infrared LED and MOS FETs on the output side.

Features

- Low driver power requirements (TTL/CMOS Compatible)
- Contact form: Normally-On (1b)
- Load voltage: 60V max.
- On-Resistance: 3Ω max.
- 3750Vrms Input/Output isolation
- Tape & Reel version available

Applications

- Telecommunications (PC, Electronic notepad)
- Measuring and Testing equipment
- Industrial control
- Security equipments
- High speed inspection machine

Outline Dimensions

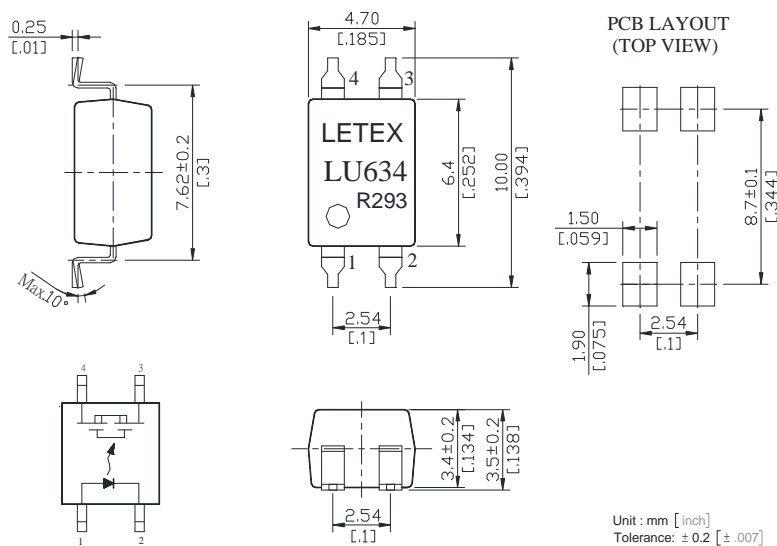

1. LED Anode
2. LED Cathode
3. Drain (MOS FET)
4. Drain (MOS FET)

Photo DMOS-FET Relay Specifications

Part Name: LU634

(Load voltage: 60V / Load current: 500mA)

Absolute Maximum Ratings (Ambient Temperature: 25°C)

Item		Symbol	Value	Units	Note
Input	Continuous LED Current	IF	50	mA	
	Peak LED Current	IFP	1000	mA	f=100Hz, duty=1%
	LED Reverse Voltage	VR	5	V	
	Input Power Dissipation	PIn	75	mW	
Output	Load Voltage	VL	60	V(AC peak or DC)	
	Load Current	IL	500	mA	
	Peak Load Current	IPeak	0.6	A	1ms(1 pulse)
	Output Power Dissipation	Pout	300	mW	
Total Power Dissipation		PT	350	mW	
I/O Breakdown Voltage		VI/O	3750	Vrms	RH=60%, 1min
Operating Temperature		Topr	-40 to +85	°C	
Storage Temperature		Tstg	-40 to +100	°C	
Pin Soldering Temperature		Tsol	260	°C	10 sec max.

Electrical Specifications (Ambient Temperature: 25°C)

Item		Symbol	MIN.	TYP.	MAX.	Units	Conditions
Input	LED Forward Voltage	V _F		1.2	1.5	V	IF=10mA
	Operation LED Current	IFon		0.5	3.0	mA	
	Recovery LED Current	IFoff	0.1	0.4		mA	
	Recovery LED Voltage	V _{Foff}	0.5			V	
Output	On-Resistance	R _{on}		1	3	Ω	IF=0mA, IL=50mA, Time to flow is within 1 sec.
	Off-State Leakage Current	I _{Leak}			1	uA	IF=5mA, VL=60V
	Output Capacitance	C _{out}		165		pF	IF=5mA, VL=0, f=1MHz
Transmis sion	Turn-On Time	T _{on}		0.5	1.5	ms	IF=5mA, IL=50mA
	Turn-Off Time	T _{off}		0.25	2.0	ms	
Coupled	I/O Isolation Resistance	R _{I/O}	10 ¹⁰			Ω	DC500V
	I/O Capacitance	C _{I/O}		0.8		pF	f=1MHz

Reference Data

Load current Vs. Ambient temperature

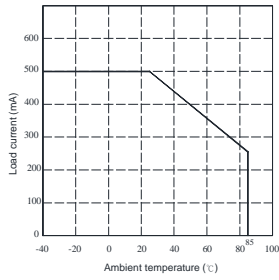

On resistance Vs. Ambient temperature

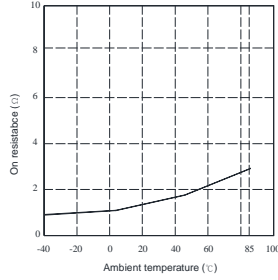

Operate (OFF) time Vs. Ambient temperature

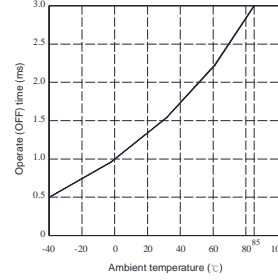

Reverse (ON) time Vs. Ambient temperature

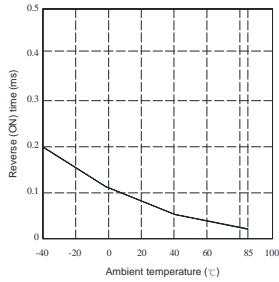

LED operate (OFF) current Vs. Ambient temperature

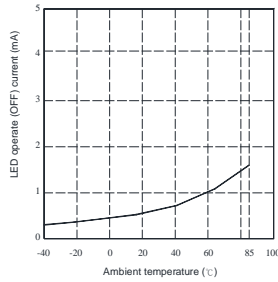

LED turn off time Vs. Ambient temperature

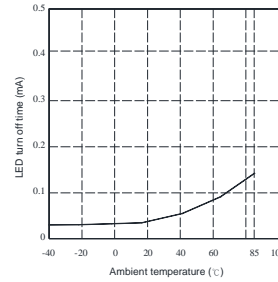

LED forward voltage Vs. Ambient temperature

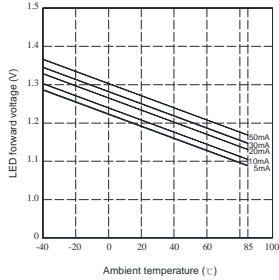

Voltage Vs. current characteristics of output at MOS portion

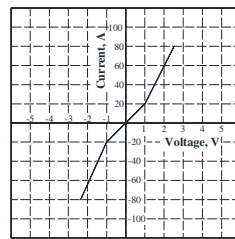

Off state leakage current Vs. Load voltage characteristics

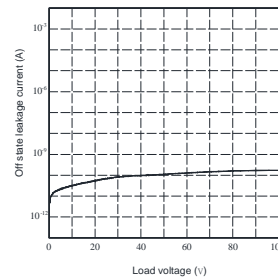

LED forward current Vs. Reverse (ON) time characteristics

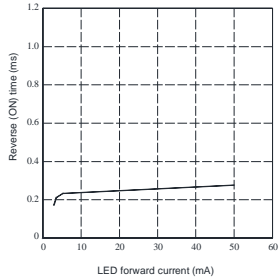

LED forward current Vs. Operate (OFF) time characteristics

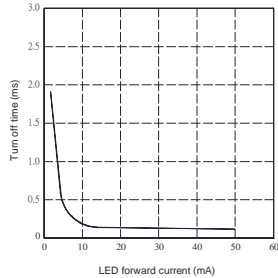

Applied voltage Vs. output capacitance characteristics

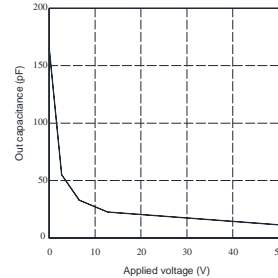

Taping Specifications for Surface Mount Devices

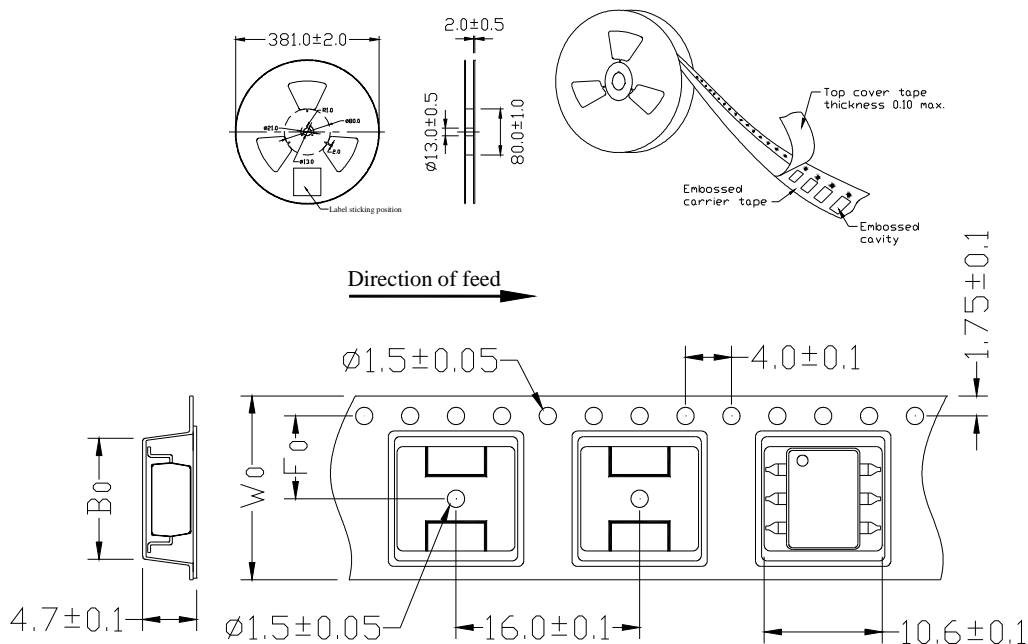

Unit: mm

TYPE	B0±0.1	F0±0.1	W0±0.1	13" REEL/PCS
4P	5.3	7.5	16	1000
6P	9.4	7.5	16	1000
8P	10.3	11.5	24	1000

Recommended Mounting Pad

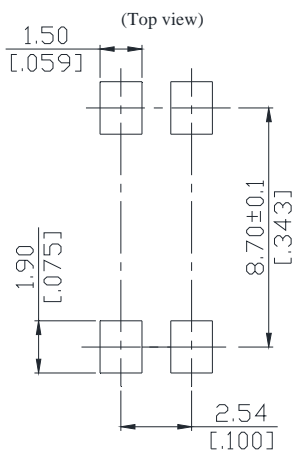

Unit : mm [inch]
Tolerance : ±0.1

Marking

(Each photo MOS Relay shall be marked with the following information)

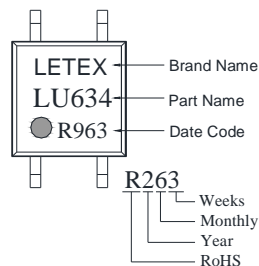

- Note: 1. There shall be leader of 230 mm minimum which may consist of carrier and or cover tape follower by a minimum of 160 mm of carrier tape sealed with cover tape.
2. There shall be a minimum of 160 mm of empty component pockets sealed with cover tape.
3. Devices are pockets in accordance with EIA standard EIA-481-A and specifications given above.