

## Photo DMOS-FET Relay

### Description

The **LT319-1** is a miniature 2-Form A solid state relay in a 8 pin SOP package that employs optically coupled MOSFET technology to provide 1500V of input to output isolation. The optically coupled input is controlled by a highly efficient GaAlAs infrared LED and MOS FETs on the output side.

### Features

- SOP package 8 Pin type in miniature design (4.4×9.4×2.0mm / .173×.37×.083inch)
- Low driver power requirements (TTL/CMOS Compatible)
- No moving parts
- High reliability
- Arc-Free with no snubbing circuits
- 1500Vrms Input/Output isolation
- Tape & Reel version available

### Applications

- Telecommunications (PC, Electronic notepad)
- Measuring and Testing equipment
- Industrial control
- Security equipments
- High speed inspection machine

### Outline Dimensions

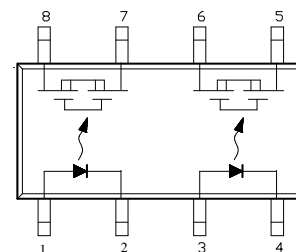
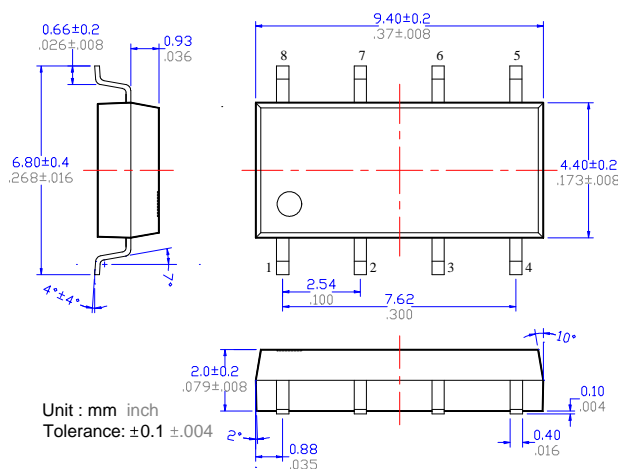

- 1,3. LED Anode
- 2,4. LED Cathode
- 5,6. Drain (MOS FET)
- 7,8. Drain (MOS FET)

## Photo DMOS-FET Relay Specifications

**Part Name: LT319-1**

(Load voltage: 60V / Load current: 1.1A)

### Absolute Maximum Ratings (Ambient Temperature: 25°C)

Item		Symbol	Value	Units	Note
Input	Continuous LED Current	I <sub>F</sub>	50	mA	
	Peak LED Current	I <sub>FP</sub>	1000	mA	f=100Hz, duty=1%
	LED Reverse Voltage	V <sub>R</sub>	5	V	
	Input Power Dissipation	P <sub>In</sub>	75	mW	
Output	Load Voltage	V <sub>L</sub>	60	V(AC peak or DC)	
	Load Current	I <sub>L</sub>	1.1	A	
	Peak Load Current	I <sub>Peak</sub>	4.0	A	100ms(1 pulse)
	Output Power Dissipation	P <sub>out</sub>	380	mW	
Total Power Dissipation		P <sub>T</sub>	450	mW	
I/O Breakdown Voltage		V <sub>I/O</sub>	1500	V <sub>rms</sub>	RH=60%, 1min
Operating Temperature		T <sub>opr</sub>	-40 to +85	°C	
Storage Temperature		T <sub>stg</sub>	-40 to +100	°C	
Pin Soldering Temperature		T <sub>sol</sub>	260	°C	10 sec max.

### Electrical Specifications (Ambient Temperature: 25°C)

Item		Symbol	MIN.	TYP.	MAX.	Units	Conditions
Input	LED Forward Voltage	V <sub>F</sub>		1.2	1.4	V	I <sub>F</sub> =10mA
	Operation LED Current	I <sub>F on</sub>		0.5	2.0	mA	
	Recovery LED Current	I <sub>F off</sub>		0.35	0.5	mA	
	Recovery LED Voltage	V <sub>F off</sub>	0.7			V	
Output	On-Resistance	R <sub>on</sub>		0.13	0.5	Ω	I <sub>F</sub> =5mA, I <sub>L</sub> =100mA, Time to flow is within 1 sec.
	Off-State Leakage Current	I <sub>Leak</sub>			1.0	uA	V <sub>L</sub> =Rating
	Output Capacitance	C <sub>out</sub>		115		pF	V <sub>L</sub> =0, f=1MHz
Transmission	Turn-On Time	T <sub>on</sub>		1.0	1.3	ms	I <sub>F</sub> =5mA, I <sub>L</sub> =100mA,
	Turn-Off Time	T <sub>off</sub>		0.6	0.8	ms	
Coupled	I/O Isolation Resistance	R <sub>I/O</sub>	10 <sup>10</sup>			Ω	DC500V
	I/O Capacitance	C <sub>I/O</sub>		0.8	1.5	pF	f=1MHz

# Reference Data

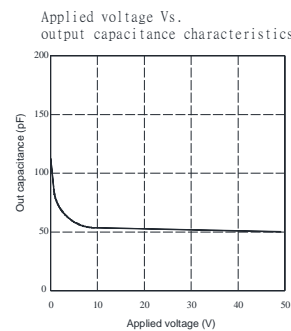
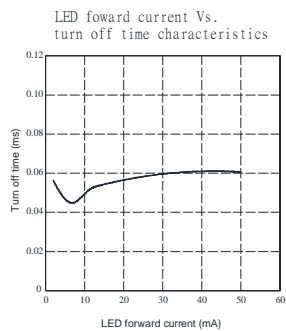
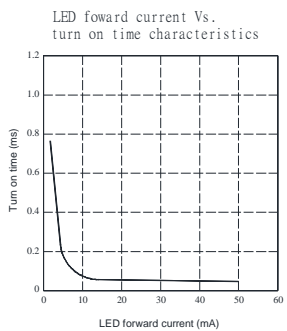
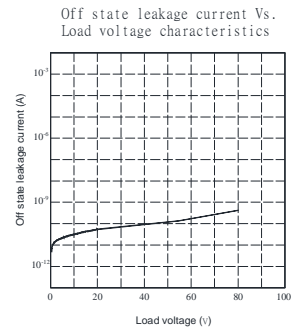
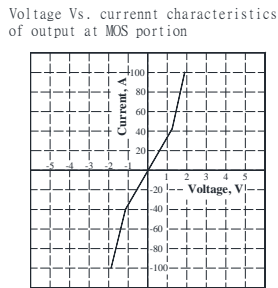
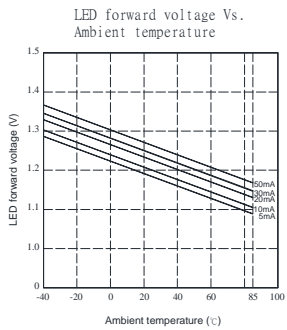
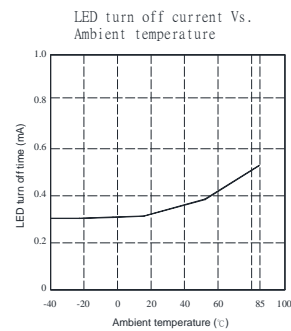
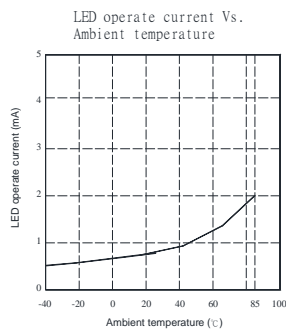
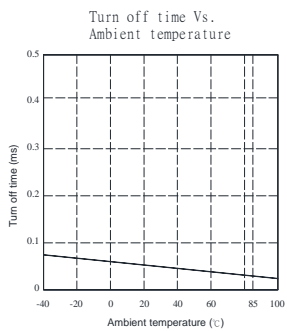
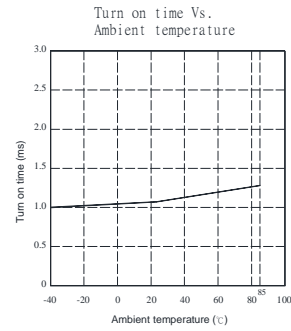
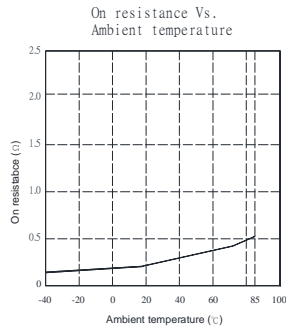
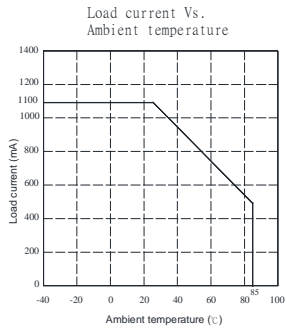

## Taping Specifications for Surface Mount Devices

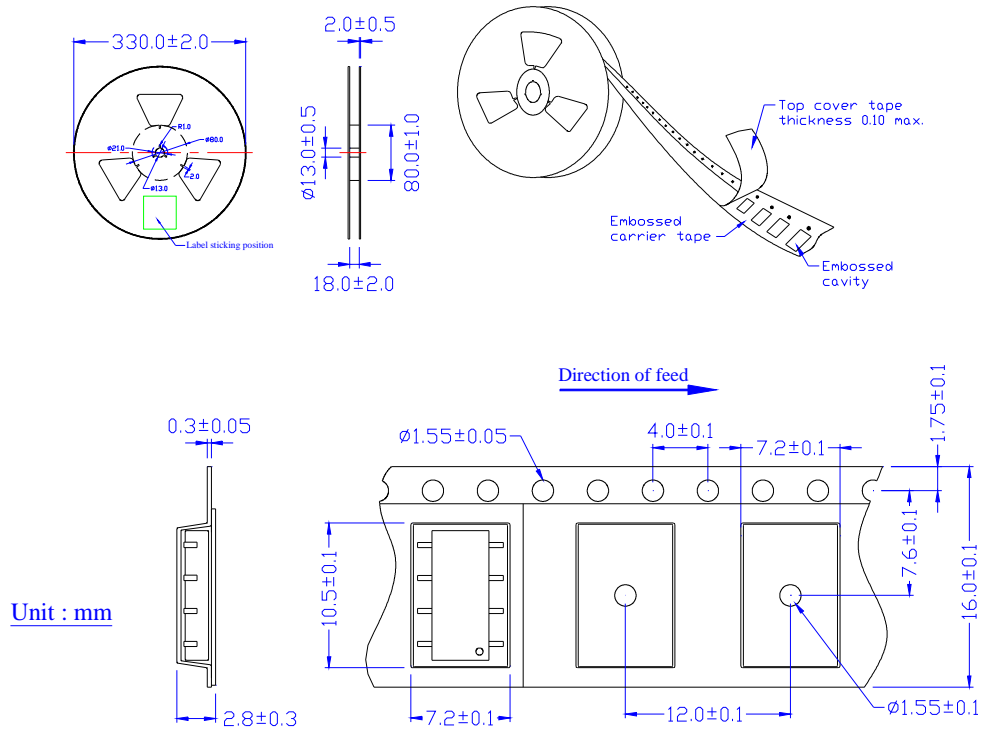

Unit : mm

### Recommended Mounting Pad

(Top view)

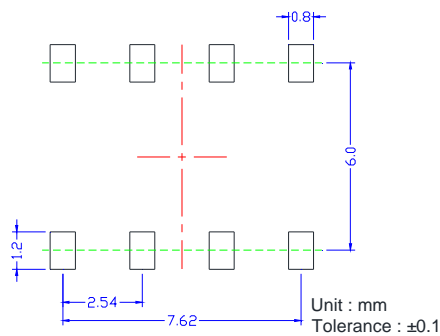

### Marking

(Each photo MOS Relay shall be marked with the following information)

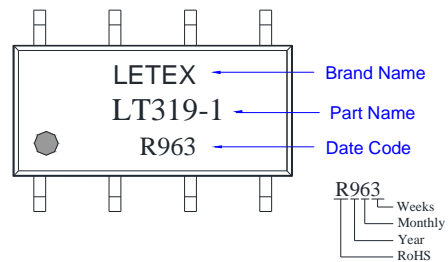

- Note: 1. There shall be leader of 230 mm minimum which may consist of carrier and or cover tape followed by a minimum of 160 mm of carrier tape sealed with cover tape.
2. There shall be a minimum of 160 mm of empty component pockets sealed with cover tape.
3. Devices are pockets in accordance with EIA standard EIA-481-A and specifications given above.
4. Packaging: 1,000pcs per reel, 2 reel per box, 5 boxes per carton.