



**BRIGHTTEK**  
**BRIGHTTEK (EUROPE) LIMITED**

**APPROVAL SHEET**

CUSTOMER: \_\_\_\_\_

TYPE NO.:   N0Y02L96  

PACKAGE SIZE:   5.0mm Round LED Lamp  

DICE MATERIAL:   GaAsP on GaP   PEAK WAVE LENGTH(nm)   587  

EMITTED COLOR:   Yellow   VIEWING ANGLE (deg):   45  

LENS COLOR:   Yellow Diffused   IV(mcd):   60

**ELECTRICAL / OPTICAL CHARACTERISTICS AT Ta = 25°C**

PARAMETER	SYMBOL	MIN	TYP	MAX	UNIT	TEST
Luminous Intensity	IV	40	60	90	mcd	IF = 20mA
Viewing Angle	2 $\theta$ 1/2		45		deg	
Peak Emission Wavelength	$\lambda_p$		587		nm	
Dominant Wavelength	$\lambda_D$	585	590	595	nm	
Spectral Line Half-Width	$\Delta\lambda$		35		nm	
Forward Voltage	VF	1.7	2.1	2.6	V	
Power Dissipation	Pd			85	mW	
Peak Forward Current ( Duty1/10 @ 1KHZ )	IF (Peak)			100	mA	
Recommended Operating Current	IF (Rec)		20		mA	

● **ABSOLUTE MAXIMUM RATINGS** : ( Ta = 25°C )

Reverse Voltage	: 5 Volt
Reverse Current	: 10 uA ( VR=5V )
Operating Temperature Range	: -40°C TO 85°C
Storage Temperature Range	: -40°C TO 100°C
Lead Soldering Temperature Range 【1.6 mm (1/16 inch) from body】	: 260°C For 5 Seconds

## LED LAMPS PACKAGE DIMENSIONS

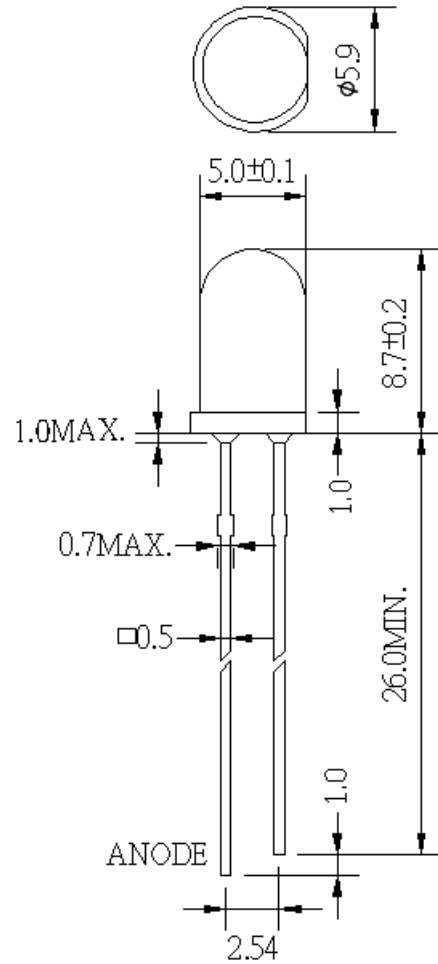

單位:mm

DEVICE NO.: N0Y02L96	DRAWING NO.	ENGINEER
ALL TOLERANCE SHALL BE $\pm 0.01$ inch/ $0.25$ mm UNLESS OTHERWISE NOTED	DRAWING DATE	APPROVER

# Typical Electro-Optical Characteristics Curves

## Yellow (GaAsP/GaP $\lambda_P=587\text{nm}$ )

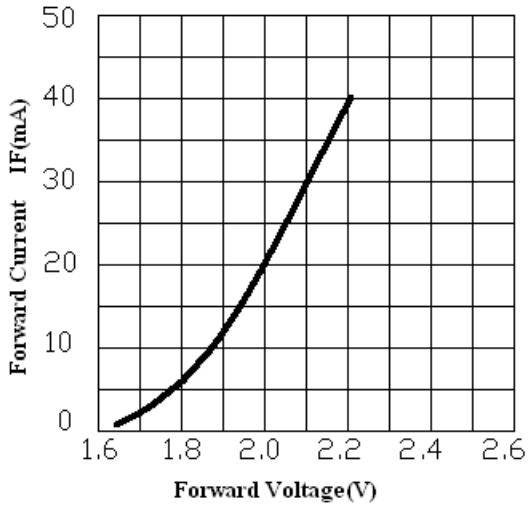

Forward Current vs. Forward Voltage

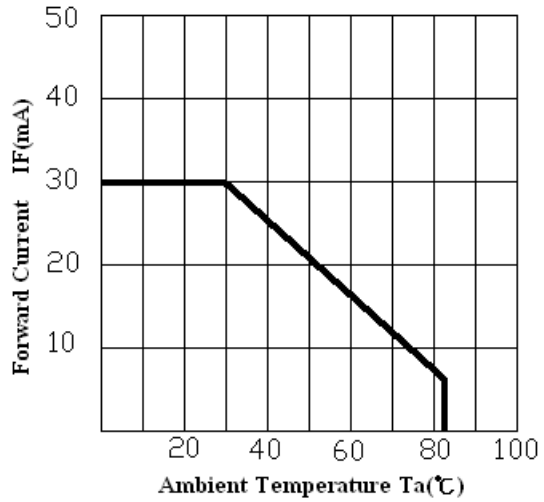

Forward Current Derating Curve

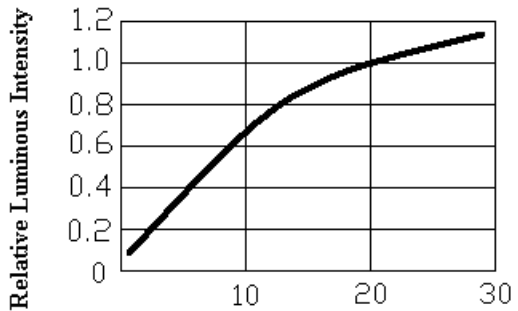

Luminous Intensity vs. Forward current

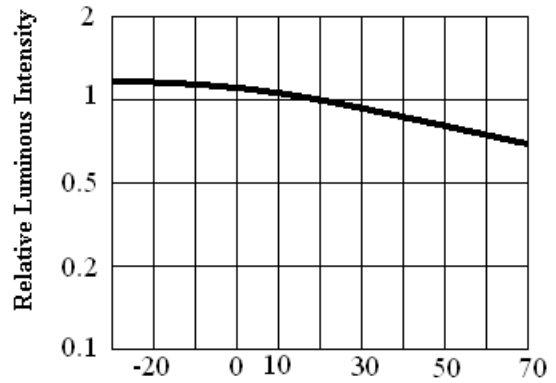

Luminous Intensity vs. Ambient Temperature

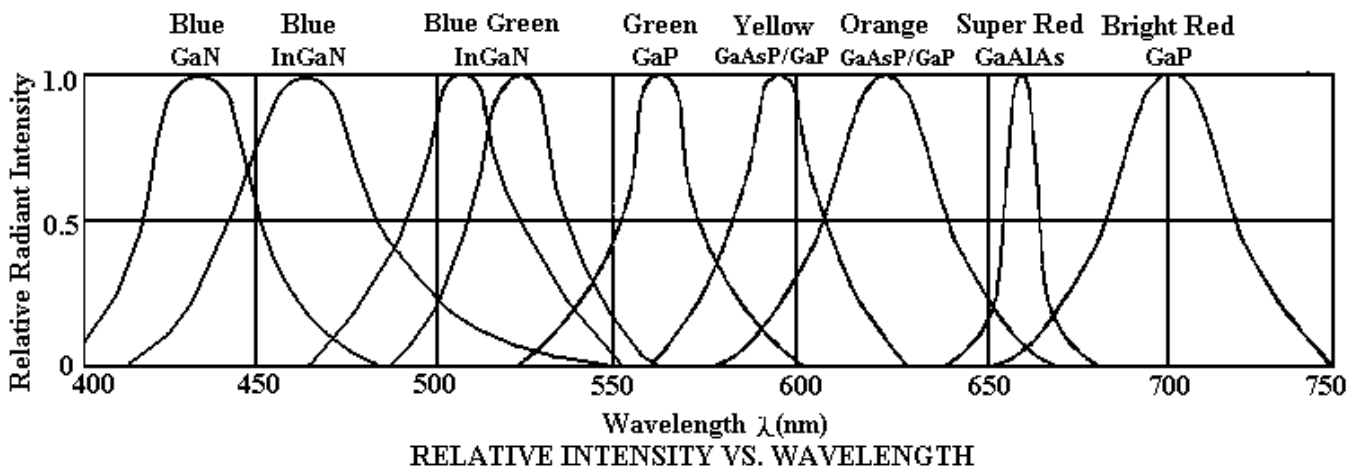

## Reliability test For LED Lamps

Type No. : N0Y02L96

NO.	Item	Test Conditions	Test Time/ Cycle	Sample Size	Ac/Re
1	DC Operating Life	Temperature:25°C IF:20mA	1000HRS	20PCS	0/1
2	High Temperature High Humidity	Temperature:85°C 85%RH	1000HRS	20PCS	0/1
3	High Temperature Storage	Temperature:100°C	1000HRS	20PCS	0/1
4	Low Temperature Storage	Temperature: - 40°C	1000HRS	20PCS	0/1
5	Temperature Cycling	85°C~ 25°C~ - 35°C 15min~ 5min~ 15min	15Cycles	20PCS	0/1
6	Thermal Shock	85°C~ 25°C~ - 10°C 5min~ 10sec ~ 5min	15Cycles	20PCS	0/1
7	Solder Heat	Temperature:260°C±5°C	10SEC.	20PCS	0/1

# Precautions For Use LED

## 1. Drive Method

LED is current-operated device. In order to ensure intensity uniformity on multiple LEDs connected in parallel in a application, it is recommended that a current limiting resistor be incorporated in the drive circuit.

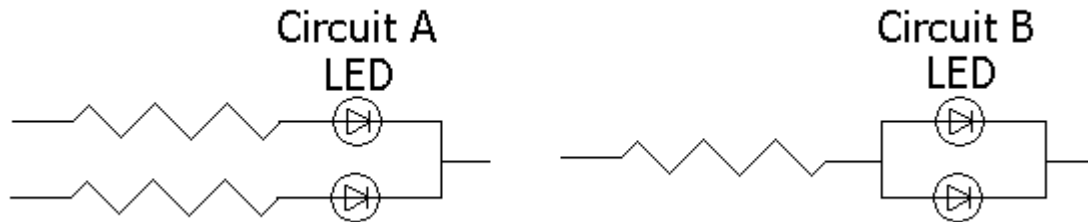

(a) Circuit A it is recommended circuit.

(b) Circuit B the brightness of each LED might appear different due to the differences in the I-V characteristics of those LEDs.

## 2. Over-current-proof

Customer must apply resistors for protection , otherwise slight voltage shift will cause big current change(Burn out will happen).

## 3. Storage

The Storage Temperature and RH are: 5°C ~ 30°C, RH 60% or less.

Once the package is opened, the products should be used with in a week. Otherwise, they should be kept in moisture proof package with moisture absorbent material (silica gel). we suggest our customers to use our products within a year.

If the moisture absorbent material (silica gel) has faded away or the LEDs exceeded the storage time , baking treatment should be performed using the following conditions.

Baking treatment: more than 24 hours at 60°C ±5°C.

## 4. Electrostatic Discharge (ESD)

Static electricity or surge voltage will damage the LEDs

Suggestions to prevent ESD damage:

Use of a conductive wrist band or ante-electrostatic glove when handing these LEDs

All devices, equipment, and machinery must be properly grounded.

Work tables storage racks, etc. should be properly grounded

In the events of manual working in process, make sure the devices are well protected from ESD at any time.

## 5. Others

(a) If want to have the uniform luminance and color, please use the same binning number,

- and avoid using intermix to cause the differences of luminance and color.
- (b) The appearance and specifications of the product may be modified for improvement without prior notice.

## 6. Soldering

Recommended soldering condition as shown below:

### Soldering heat (DIP)

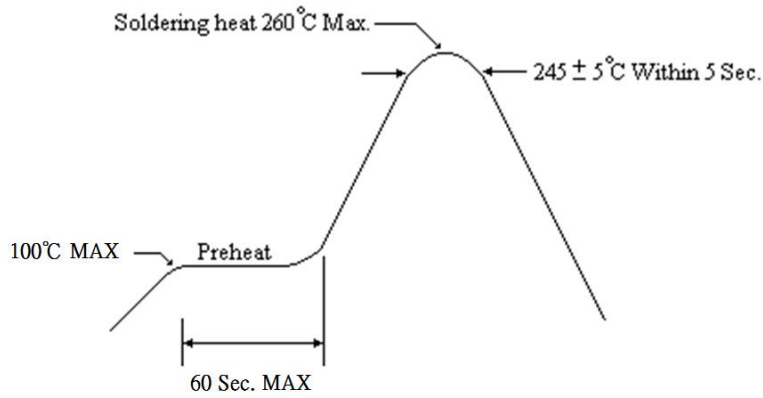

### Soldering Iron

Temperature at tip of iron : 350°C Max.

Soldering Time: 3 sec.  $\pm$  1 sec. (one time only)

If temperature is higher, time should be shorter