



BRIGHTTEK
BRIGHTTEK (EUROPE) LIMITED

Brighten up The World With LED!



ISO/TS 16949:2009



BS EN ISO 14001:2004



QC 080000 IECQ HSPM

PRODUCT DATASHEET



- ▶ PLCC2 SMD
- ▶ 2835 0.7t
- ▶ Warm White (2700K)

NOW49S76



Release Date: 07 August 2019 Version: A1.0



2835 PLCC2 Series

RoHS
Compliant



FEATURES:

- **Package:** PLCC2 Top View White Package
- **Forward Current:** 150mA
- **Forward Voltage (typ.):** 3.1V
- **Luminous Flux (typ.):** 67lm@150mA
- **Colour:** Warm White
- **Colour Temperature (CCT):** 2700K
- **Viewing angle:** 120°
- **Materials:**
 - Die: InGaN
 - Resin: Silicon (Yellow Diffused)
 - Finish: Ag plated
- **Operating Temperature:** -40~+85°C
- **Storage Temperature:** -40~+100°C
- **Electrostatics Discharge:** 1000V
- **Grouping parameters:**
 - Forward Voltage
 - Luminous Flux
 - CIE Chromaticity
- **Soldering methods:** Reflow Soldering
- **MSL Level:** MSL3 according to J-STD020
- **Packing:** 8mm tape with Max. 18000/reel, ø355mm/14”

APPLICATIONS:

- General Lighting
- Portable Lighting
- Commercial Lighting
- Indoor Lighting
- Backlight for LCD
- Architectural Lighting

CHARACTERISTICS:

Absolute Maximum Characteristics (Ta=25°C, RH=60%)

Parameter	Symbol	Ratings	Unit
DC Forward Current	I _F	240	mA
Pulse Forward Current (Duty 1/10, width≤100μS)	I _{PF}	280	mA
Power Dissipation	P _D	790	mW
Reverse Voltage	V _R	5	V
Reverse Current @10V	I _R	10	μA
Junction Temperature	T _j	120	°C
Electrostatic Discharge	ESD	1000	V
Thermal Resistance (Junction to Solder Point)	R _{THJS}	16	°C/W
Operating Temperature	T _{OPR}	-40~+85	°C
Storage Temperature	T _{STG}	-40~+100	°C
Soldering Temperature	T _{SOL}	230 or 260 for 10S	°C
Colour Rendering Index	CRI	80	---

Electrical & Optical Characteristics (Ta=25°C, RH=60%)

Parameter	Symbol	Values			Unit	Test Condition
		Min.	Typ.	Max.		
Forward Voltage	V _F	2.7	---	3.3	V	I _F =150mA
Luminous Flux	Φ _v	60	67	75	lm	I _F =150mA
Chromaticity Coordinates	X	---	0.4620	---	---	I _F =150mA
	Y	---	0.4145	---		
Colour Temperature	CCT	--	2700	---	K	I _F =150mA
Viewing Angle	2θ _{1/2}	---	120	---	deg	I _F =150mA

1. Luminous flux (Φ_v) ±10%, Forward Voltage (V_F) ±0.1V

OUTLINE DIMENSION:

Package Dimension:

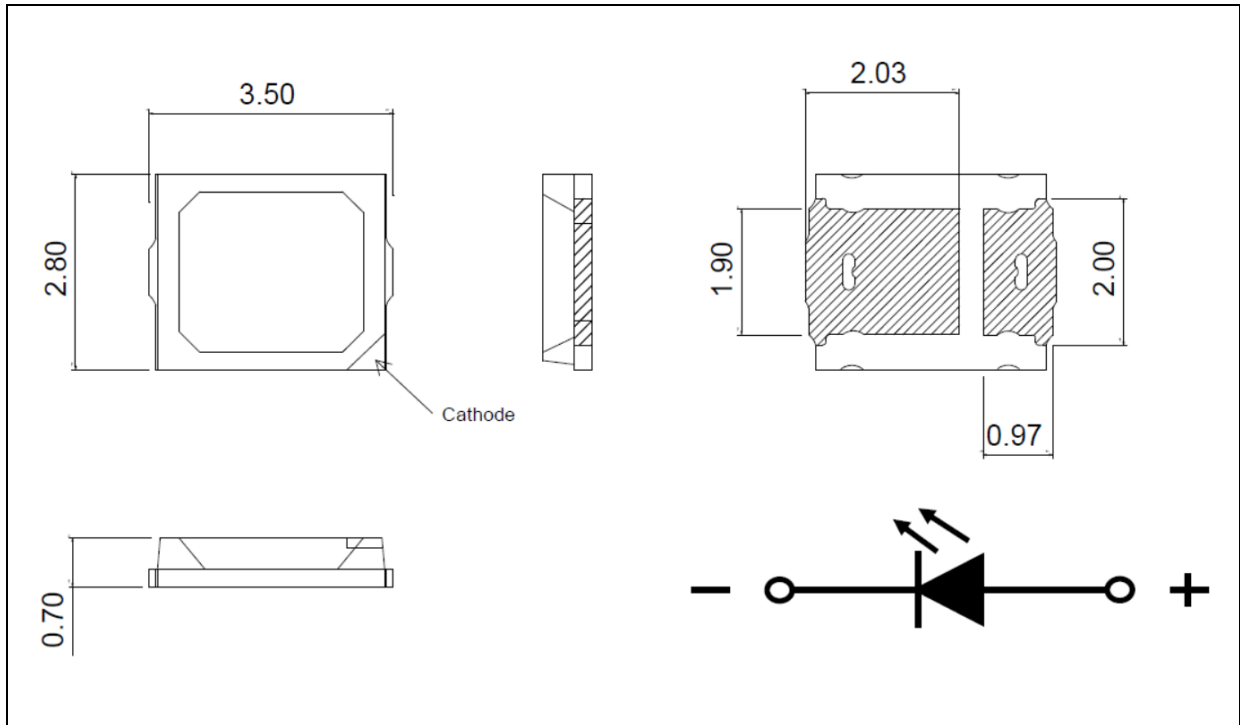

1. All dimensions are in millimetre (mm).
2. Tolerance $\pm 0.2\text{mm}$, unless otherwise noted.

BINNING GROUPS:

 Forward Voltage Classifications ($I_F = 150\text{mA}$):

Code	Min.	Max.	Unit
A1	2.7	2.8	V
B1	2.8	2.9	
C1	2.9	3.0	
D1	3.0	3.1	
E1	3.1	3.2	
F1	3.2	3.3	

 Luminous Flux Classifications ($I_F = 150\text{mA}$):

Code	Min.	Max.	Unit
1S	60	65	lm
1T	65	70	
1W	70	75	

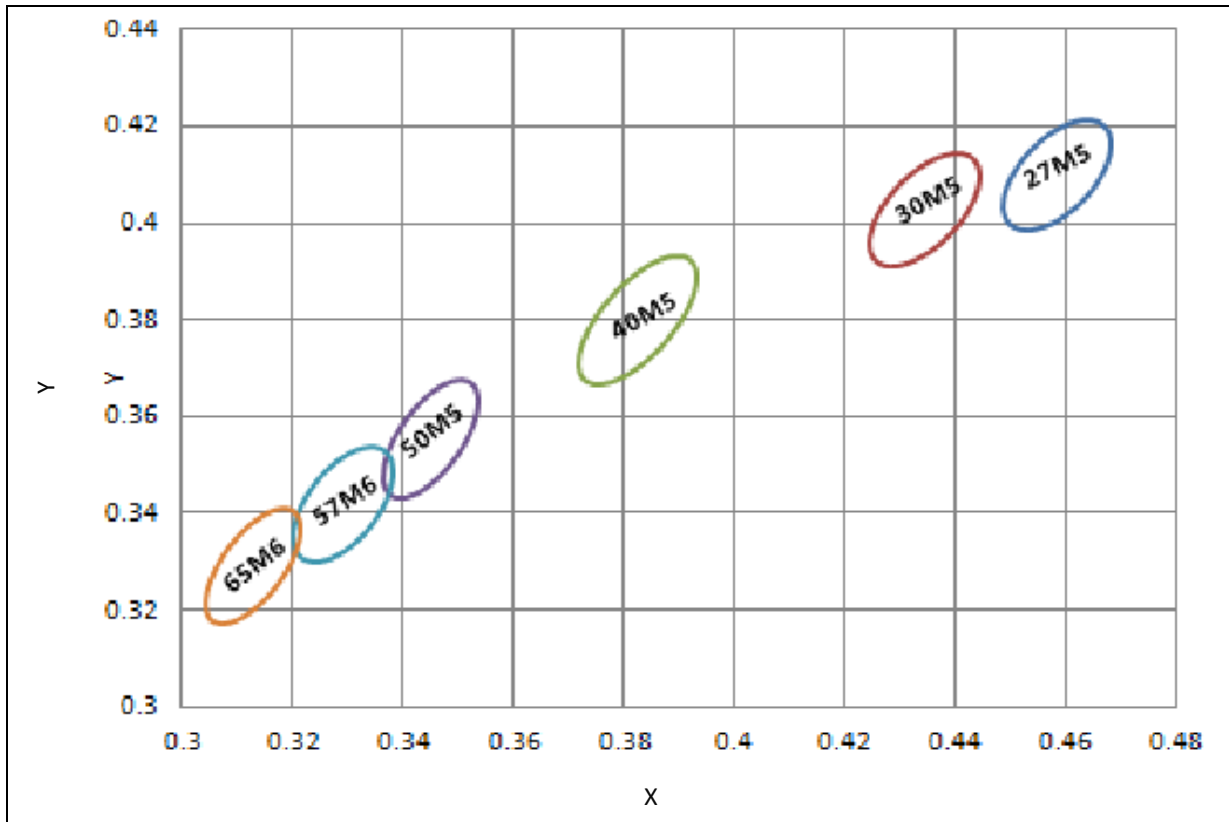
CIE CHROMATICITY DIAGRAM:

Chromaticity Coordinates Classifications ($I_F = 150\text{mA}$):

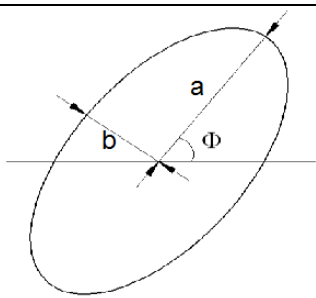
Code	Centre		Radius		Angle
	X	Y	a	b	Φ
27R5	0.4620	0.4145	0.01350	0.00700	53.42

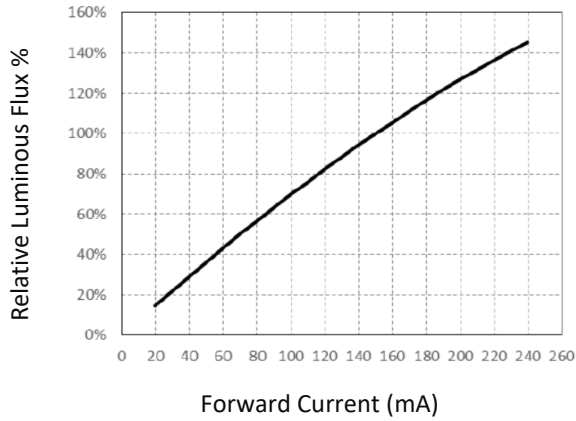
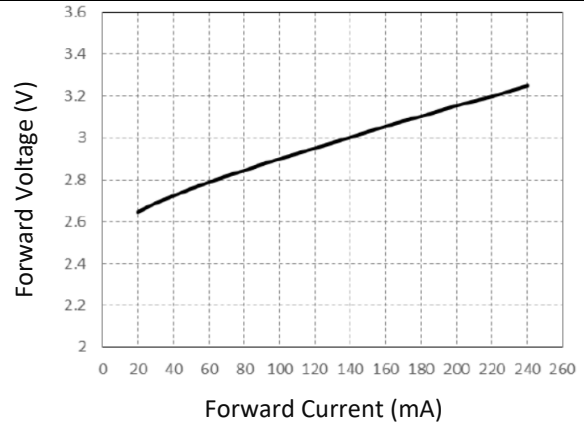
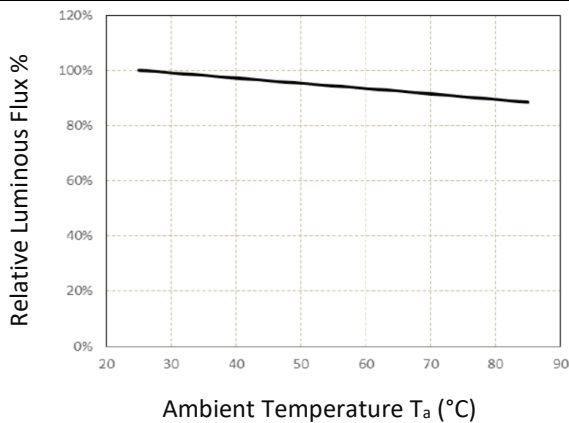
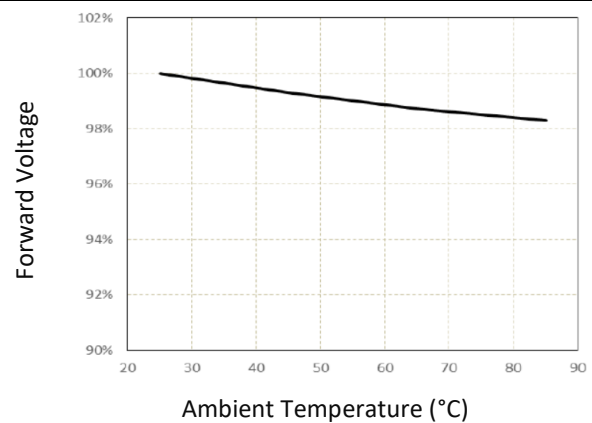
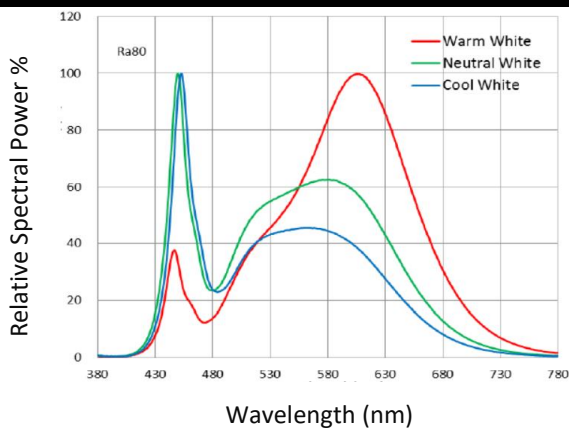
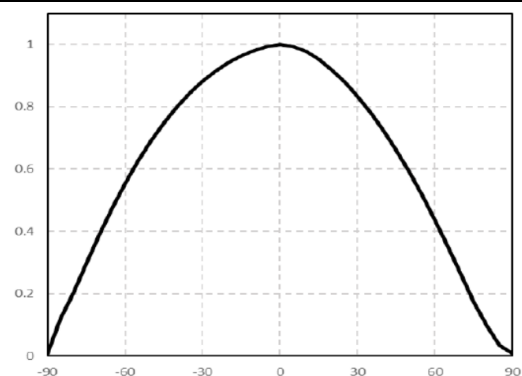

ELECTRO-OPTICAL CHARACTERISTICS:
Relative Luminous Flux v.s. Forward Current

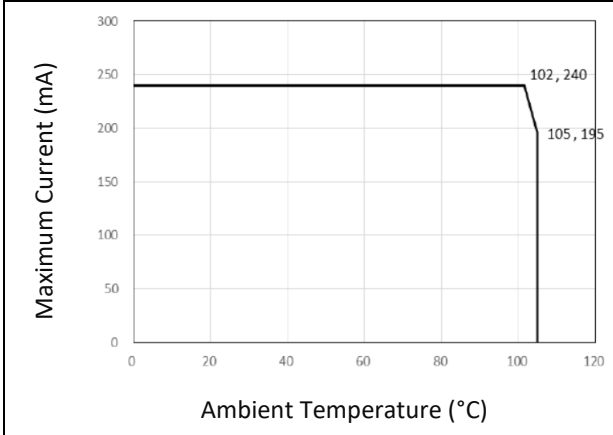
Forward Current v.s. Forward Voltage

Relative Luminous Flux v.s. Ambient Temp.

Forward Voltage v.s. Ambient Temp.

Relative Spectral Power v.s. Wavelength

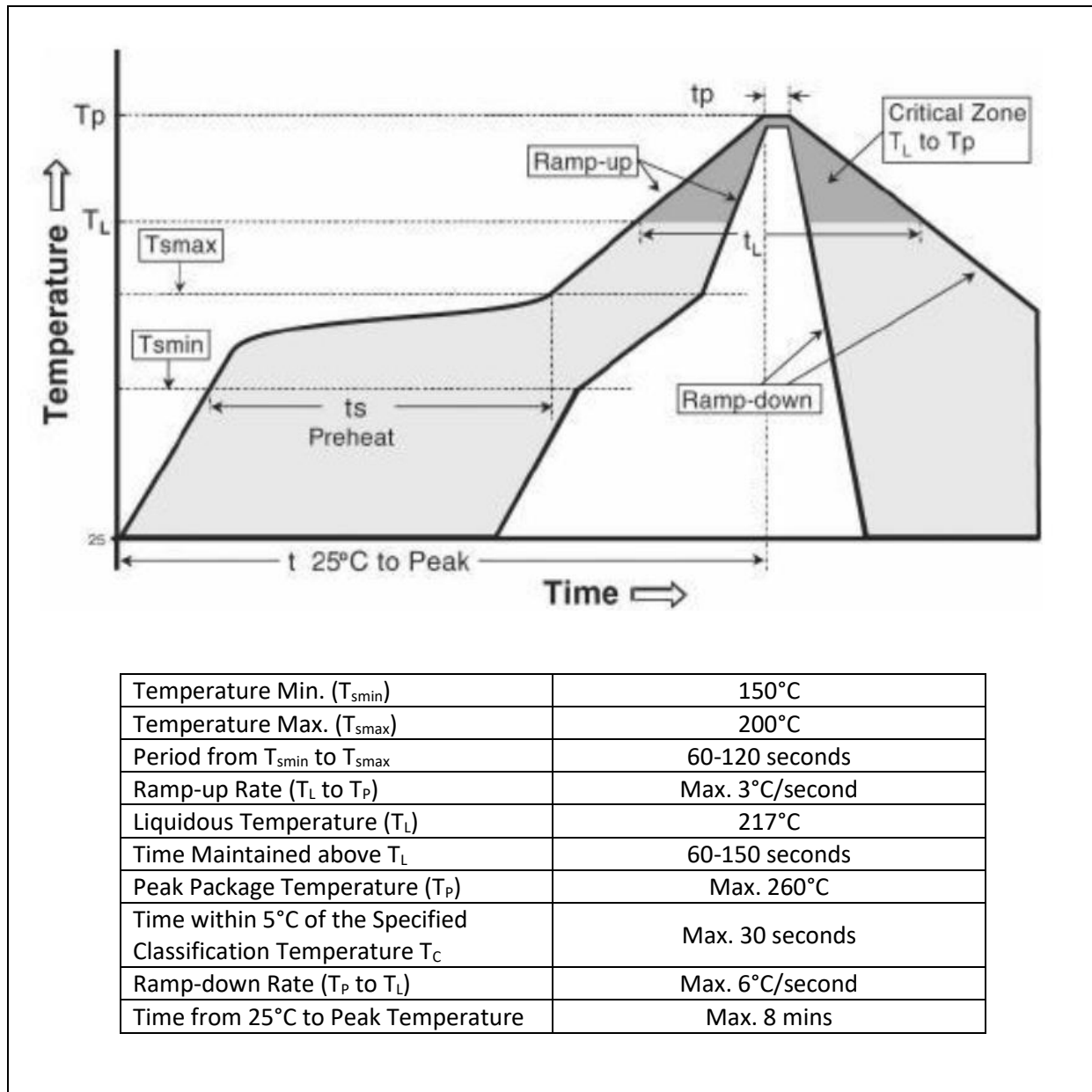
Directive Radiation

Forward Current Derating Curve



RECOMMENDED SOLDERING PROFILE:

Reflow Lead-free Solder:



Note:

1. Maximum reflow soldering: 2 times.
2. Before, during, and after soldering, should not apply stress on the components and PCB board.
3. Recommended soldering temperature: 230°C. The maximum soldering temperature should be limited to 260°C for max. 10seconds.

PACKING SPECIFICATION:

Reel Dimension:

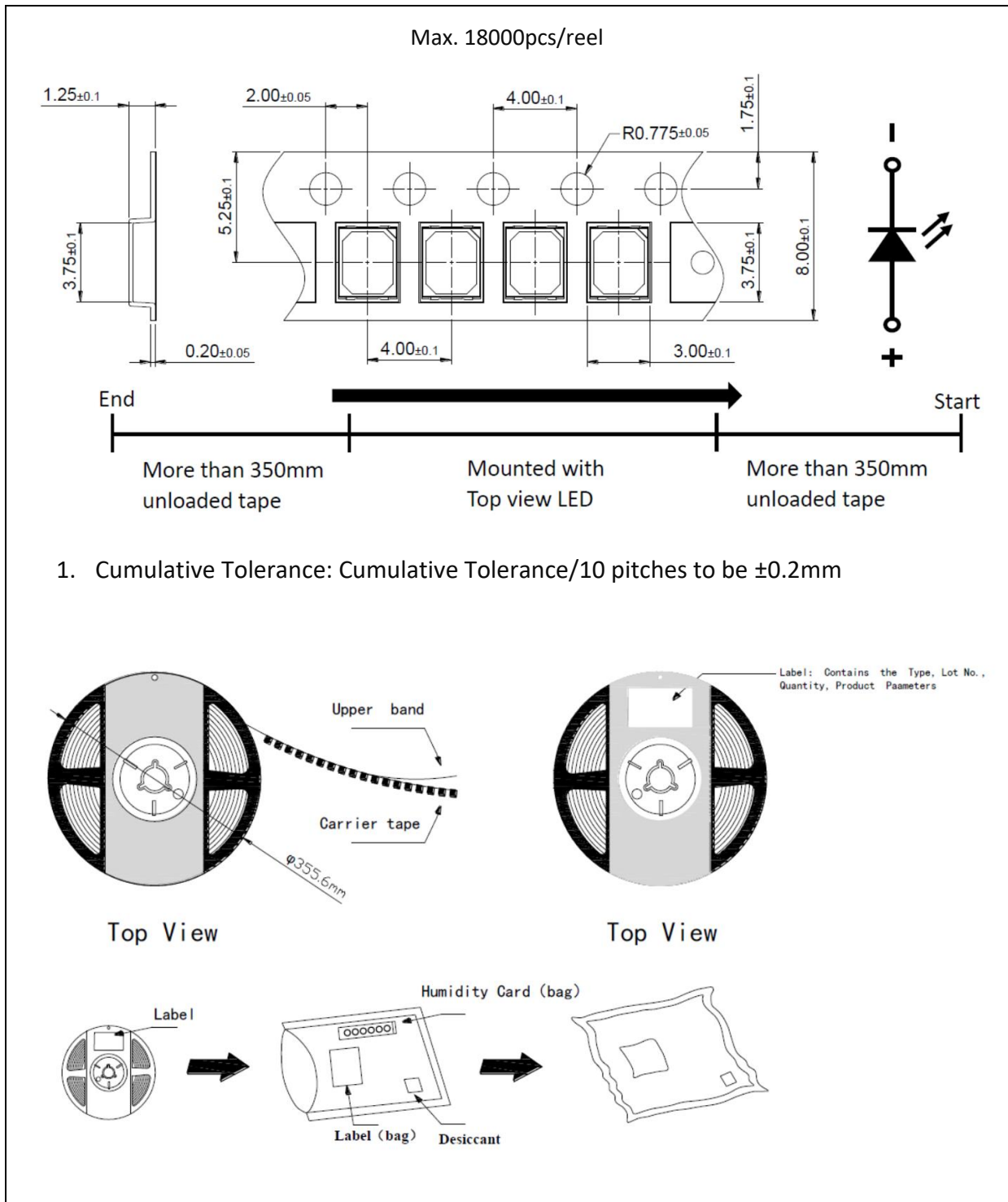

PRECAUTIONS OF USE:

Storage:

It is recommended to store the products in the following conditions:

- Humidity: 60% R.H. Max.
- Temperature: 5°C~30°C (41°F ~86°F).

Shelf life in sealed bag: 12 months at 5°C~30°C and <60% R.H.

Once the package is opened, the products should be used within a week. Otherwise, they should be kept in a damp-proof box with desiccating agent and apply baking.

Baking:

It is recommended to bake the LED before soldering if the pack has been unsealed for longer than 24hrs. The suggested baking conditions are as followings:

- 60±3°C x 24hrs and <5%RH, taped / reel package.

It's normal to see slight color fading of carrier (light yellow) after baking in process.

Testing Circuit:



Must apply resistor(s) for protection (over current proof).

Cleaning:

Use alcohol-based cleaning solvents such as isopropyl alcohol to clean the LED carrier / package. Avoid putting any stress force directly on to the LED lens.

ESD (Electrostatic Discharge):

Static Electricity or power surge will damage the LED. Use of a conductive wrist band or anti-electrostatic glove is recommended when handling the LED all time. All devices, equipment, machinery, worktables, and storage racks must be properly grounded.

In the events of manual working in process, make sure the devices are well protected from ESD at any time.

REVISION RECORD:

Version	Date	Summary of Revision
A1.0	07/08/2019	Datasheet set-up.