



BRIGHTTEK
BRIGHTTEK (EUROPE) LIMITED

APPROVAL SHEET

CUSTOMER: _____

TYPE NO.: NOW33L09Z

PACKAGE SIZE: 5.0mm Round Type LED Lamp

DICE MATERIAL: InGaN Chromaticity Coordinate: x=0.40 y=0.41

EMITTED COLOR: Warm White VIEWING ANGLE (deg): 20

LENS COLOR: Water Clear IV(mcd): 20000

ELECTRICAL / OPTICAL CHARACTERISTICS AT Ta = 25°C

PARAMETER	SYMBOL	MIN	TYP	MAX	UNIT	TEST
Luminous Intensity	IV	11000	20000	32000	mcd	IF = 20mA
Viewing Angle	2 θ 1/2		20		deg	
Chromaticity Coordinate	X		0.40		nm	
Chromaticity Coordinate	Y		0.41		nm	
Spectral Line Half-Width	$\Delta\lambda$				nm	
Forward Voltage	VF	2.8	3.2	3.4	V	
Power Dissipation	Pd			85	mW	
Peak Forward Current (Duty1/10 @ 1KHZ)	IF (Peak)			100	mA	
Recommended Operating Current	IF (Rec)		20		mA	

● **ABSOLUTE MAXIMUM RATINGS** : (Ta = 25°C)

Reverse Voltage	: 5 Volt
Reverse Current	: 10 uA (VR=5V)
Electrostatic Discharge (ESD)	: 2000 Volt
Operating Temperature Range	: -40°C TO 85°C
Storage Temperature Range	: -40°C TO 100°C
Lead Soldering Temperature Range	
【1.6 mm (1/16 inch) from body】	: 260°C For 5 Seconds

LED LAMPS PACKAGE DIMENSIONS

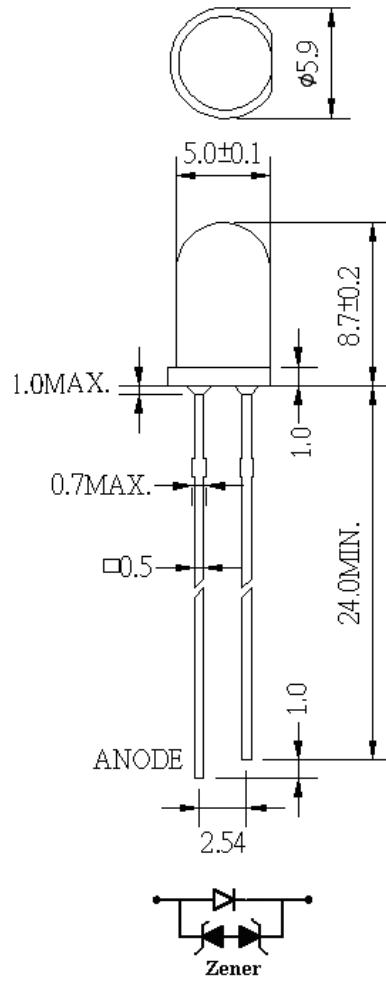

DEVICE NO.: N0W33L09Z	DRAWING NO.	ENGINEER
ALL TOLERANCE SHALL BE ± 0.01 inch/0.25mm UNLESS OTHERWISE NOTED	DRAWING DATE	APPROVER

White Typical Electrical Optical Characteristics Curves

(Ta=25°C Ambient Temperature Unless Otherwise Noted)

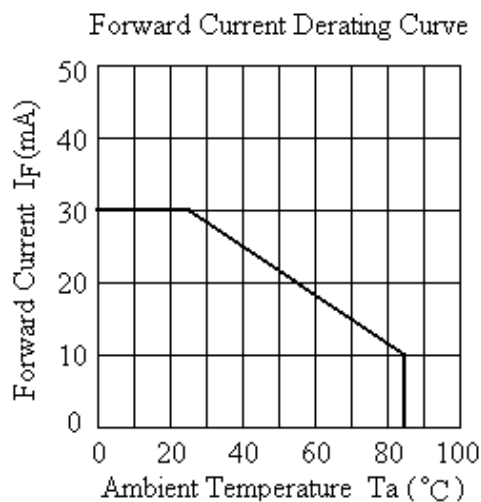
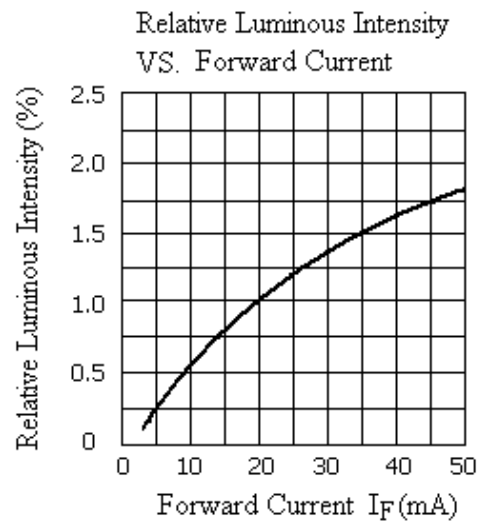
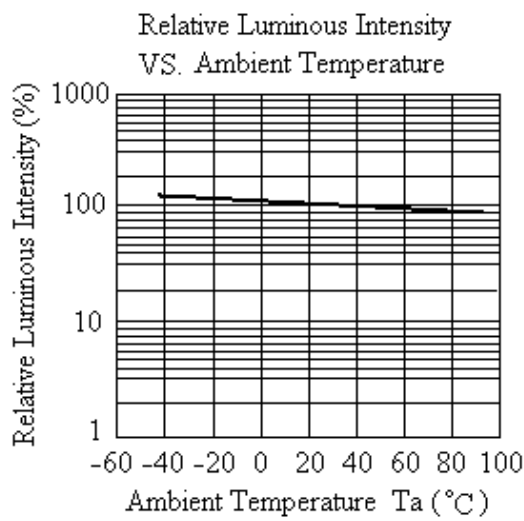
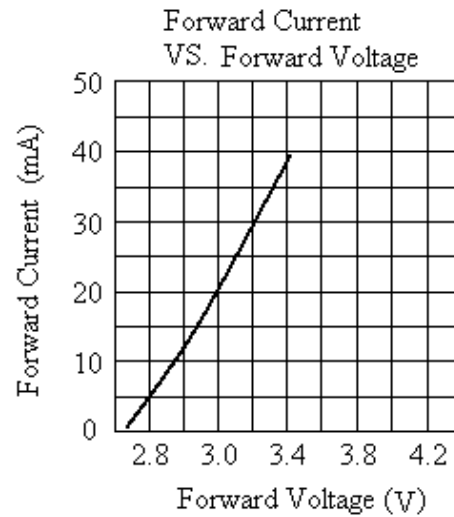
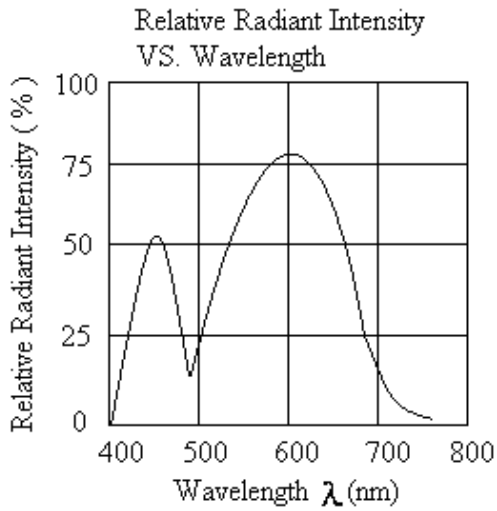

Bin Code Explanation

Bin Code:

VF: Bin Range of Forward Voltage (Unit: V)

BIN A: 1.0~1.2	BIN B: 1.2~1.4	BIN C: 1.4~1.6	BIN D: 1.6~1.8	BIN E: 1.8~2.0
BIN F: 2.0~2.2	BIN G: 2.2~2.4	BIN H: 2.4~2.6	BIN I: 2.6~2.8	BIN J: 2.8~3.0
BIN K: 3.0~3.2	BIN L: 3.2~3.4	BIN M: 3.4~3.6	BIN N: 3.6~3.8	BIN P: 3.8~4.0
BIN Q: 4.0~4.2	BIN R: 4.2~4.4	BIN S: 4.4~4.6	BIN T: 4.6~4.8	

IV:

Bin Range of Luminous Intensity (Unit: mcd)

BIN 1: 0.1~4	BIN 2: 4~6	BIN 3: 6~9	BIN 4: 9~13	BIN 5: 13~19
BIN 6: 19~28	BIN 7: 28~42	BIN 8: 42~63	BIN 9: 63~94	BIN 10: 94~140
BIN 11: 140~210	BIN 12: 210~310	BIN 13: 310~460	BIN 14: 460~690	BIN 15: 690~1000
BIN 16: 1000~1500	BIN 17: 1500~2200	BIN 18: 2200~3300	BIN 19: 3300~4900	BIN 20: 4900~7300
BIN 21: 7300~11000	BIN 22: 11000~16500	BIN 23: 16500~25000	BIN 24: 25000~32000	BIN 25: 32000~40000
BIN 26: 40000~50000	BIN 27: 50000~60000			

Color Rank (White)

XY:

BIN CODE	Top		Right		Bottom		Left	
	X1	Y1	X2	Y2	X3	Y3	X4	Y4
BIN YY1	0.365	0.390	0.380	0.405	0.400	0.395	0.385	0.380
BIN YY2	0.380	0.405	0.395	0.420	0.415	0.410	0.400	0.395
BIN YY3	0.395	0.420	0.410	0.435	0.43	0.425	0.415	0.410
BIN YY4	0.410	0.435	0.425	0.450	0.445	0.440	0.430	0.425
BIN YY5	0.425	0.450	0.440	0.465	0.473	0.446	0.460	0.430

CIE Chromaticity Diagram

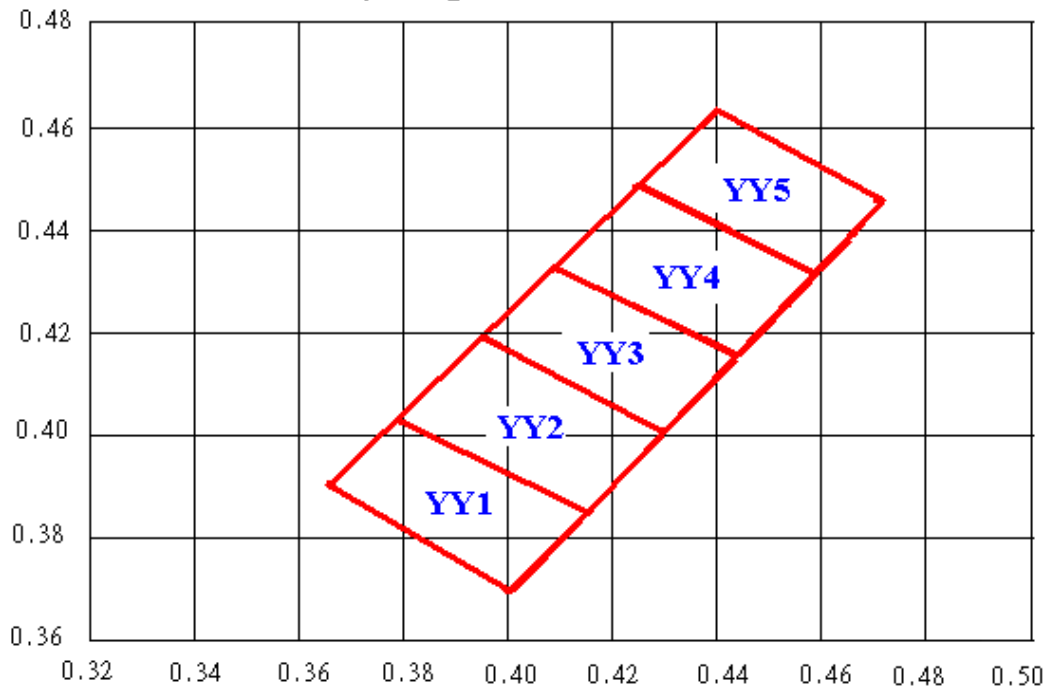

CIE chromaticity Coordinates Diagram

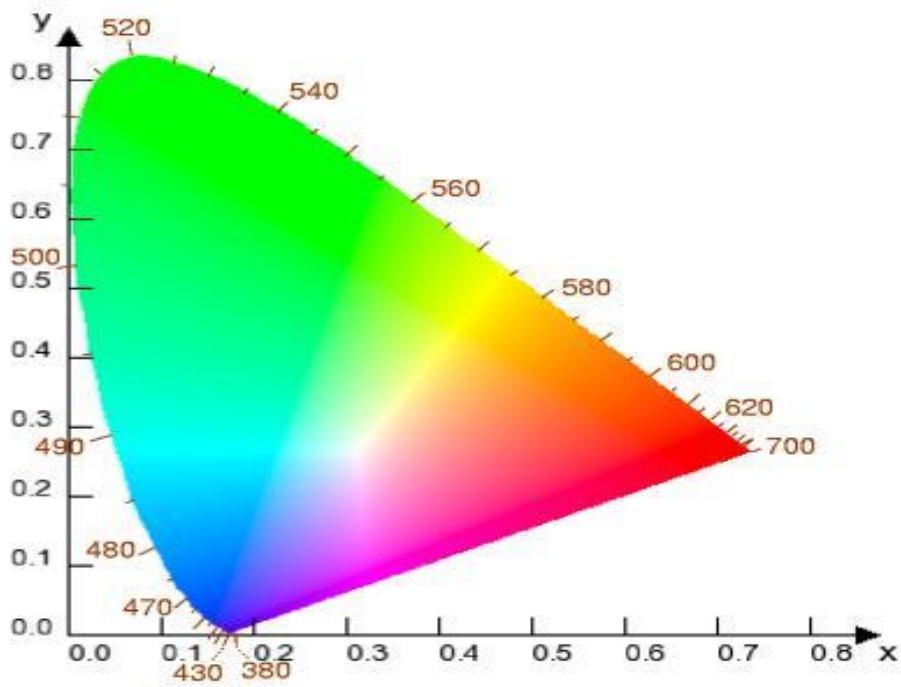

Reliability test For LED Lamps

Type No. : N0W33L09Z

NO.	Item	Test Conditions	Test Time/ Cycle	Sample Size	Ac/Re
1	DC Operating Life	Temperature:25°C IF:20mA	1000HRS	20PCS	0/1
2	High Temperature High Humidity	Temperature:85°C 85%RH	1000HRS	20PCS	0/1
3	High Temperature Storage	Temperature:100°C	1000HRS	20PCS	0/1
4	Low Temperature Storage	Temperature: - 40°C	1000HRS	20PCS	0/1
5	Temperature Cycling	85°C~ 25°C~ - 35°C 15min~ 5min~ 15min	15Cycles	20PCS	0/1
6	Thermal Shock	85°C~ 25°C~ - 10°C 5min~ 10sec ~ 5min	15Cycles	20PCS	0/1
7	Solder Heat	Temperature:260°C±5°C	10SEC.	20PCS	0/1

Precautions For Use LED

1. Drive Method

LED is current-operated device. In order to ensure intensity uniformity on multiple LEDs connected in parallel in a application, it is recommended that a current limiting resistor be incorporated in the drive circuit.

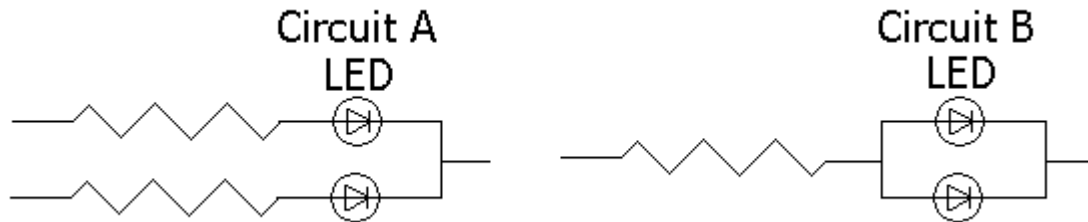

(a) Circuit A it is recommended circuit.

(b) Circuit B the brightness of each LED might appear different due to the differences in the I-V characteristics of those LEDs.

2. Over-current-proof

Customer must apply resistors for protection , otherwise slight voltage shift will cause big current change(Burn out will happen).

3. Storage

The Storage Temperature and RH are: 5°C ~ 30°C, RH 60% or less.

Once the package is opened, the products should be used with in a week. Otherwise, they should be kept in moisture proof package with moisture absorbent material (silica gel). we suggest our customers to use our products within a year.

If the moisture absorbent material (silica gel) has faded away or the LEDs exceeded the storage time , baking treatment should be performed using the following conditions.

Baking treatment: more than 24 hours at 60°C ±5°C.

4. Electrostatic Discharge (ESD)

Static electricity or surge voltage will damage the LEDs

Suggestions to prevent ESD damage:

Use of a conductive wrist band or ante-electrostatic glove when handing these LEDs

All devices, equipment, and machinery must be properly grounded.

Work tables storage racks, etc. should be properly grounded

In the events of manual working in process, make sure the devices are well protected from ESD at any time.

5. Others

(a) If want to have the uniform luminance and color, please use the same binning number,

and avoid using intermix to cause the differences of luminance and color.

(b) The appearance and specifications of the product may be modified for improvement without prior notice.

6. Soldering

Recommended soldering condition as shown below:

Soldering heat (DIP)

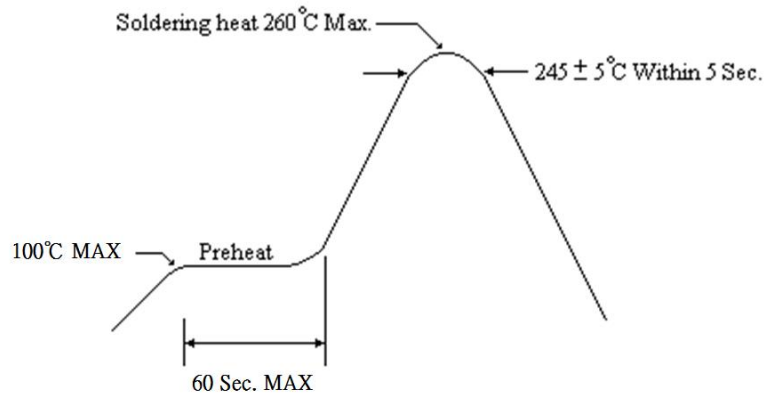

Soldering Iron

Temperature at tip of iron : 350°C Max.

Soldering Time: $3 \text{ sec.} \pm 1 \text{ sec.}$ (one time only)

If temperature is higher, time should be shorter