

N0B08L33S

◆Outline (L* W*H): 3.9*3.1*6.2mm

◆Good thermal dissipation & optical uniformity



Table of Contents

Product Code Method -----	2
Maximum Rating-----	2
Typical Product Characteristics-----	3
Range of Bins-----	3
Directive Characteristics-----	4
Electronic-Optical Characteristics-----	5
Dimensions-----	6
Packing-----	7
Precautions-----	8
Test Items and Results of Reliability-----	11

Features

- Forward current: $\leq 30\text{mA}$
- Typical view angle 50% I_v : $100^\circ/60^\circ$
- Lens color: blue diffused
- RoHS and REACH-compliant
- ESD level 1kV(HBM)

Applications

- Indoor decorating
- Outdoor lighting for amusement
- Consumer electronics
- Other applications

Product Code Method

①	②	③	④	⑤
Process Type	Product Type	Specification	Lead Frame Code	Dice Wavelength & Luminous rank
1: normal process	L: lamp LED	43: oval 3.9*3.1mm	26:frame	Bxxx : blue

⑥	⑦	⑧	⑨	⑩
Polarity Code	Resin Color Code	Article Mode Code	Special Process Requirements	Assembly code
0: tinned and polarity	D: blue diffused	H: article mode	3:tinning and cut1.2mm	03: no expression above meaning for company

Maximum Rating(Ta=25°C)

Characteristics	Symbol	Rating	Unit
DC Forward Current	I _F	30	mA
Pulse Forward Current ^{*3}	I _{PF}	80	mA
Reverse Voltage	V _R	5	V
Power Dissipation	P _D	100	mW
Junction Temperature	T _J	110	°C
Operating Temperature Range	T _{OP}	-40~80	°C
Storage Temperature Range	T _{STG}	-40~100	°C
Soldering Temperature ^{*4}	T _{SD}	260	°C

Notes 1: There is no maximum or typical voltage parameter

2: For other ambient, limited setting of current will be depended on de-rating curves.

3: Duty 1/10, pulse width 0.1ms

4: The maximum of soldering time is 5 seconds in T_{SD}

Typical Product Characteristics(Ta=25°C)

Characteristics	Symbol	Min	Typical	Max	Unit	Test condition	
Forward Voltage	V_F	2.8	3.2	3.6	V	$I_F=20\text{mA}$	
Reverse Current	I_R	-	-	10	μA	$V_R=5\text{V}$	
Luminous Intensity	I_V	600	720	-	mcd	$I_F=20\text{mA}$	
Dominant Wavelength	λ_d	464		473	nm	$I_F=20\text{mA}$	
View Angle	$2\theta_{1/2}$	X	-	100	-	deg	$I_F=20\text{mA}$
		Y	-	60	-		

Notes: 1. Measurement Errors:

Forward Voltage: $\pm 0.1\text{V}$, Luminous Intensity: $\pm 10\%I_V$, Dominant Wavelength: $\pm 1.0\text{nm}$

2. Electrical-Optical Characteristics (Ta=25°C)

Range of Bins
1).Forward Voltage Bins ($I_F=20\text{mA}$)

Bin Code	Min. V_F (V)	Max. V_F (V)
A	-	2.8
B	2.8	3.6
C	3.6	-

2).Luminous Intensity Bins ($I_F=20\text{mA}$)

Bin code	Min. I_V (mcd)	Max. I_V (mcd)
7	600	720
8	720	870
9	870	1050

■ Range of Bins

3).Dominant Wavelength Bins ($I_F=20mA$)

Bin Code	Min. λ_d (nm)	Max. λ_d (nm)
A	464	467
B	467	470
C	470	473

■ Directive Characteristics($T_a=25^\circ C$)

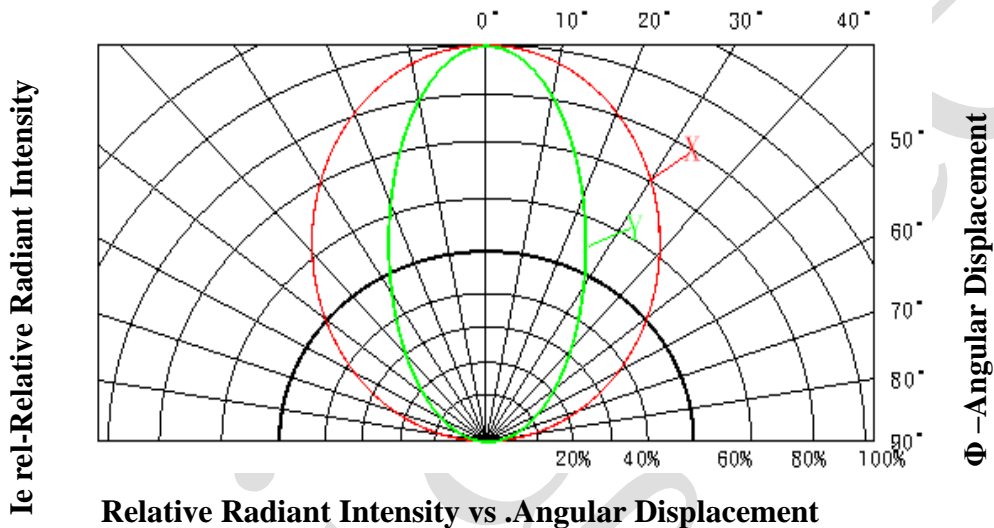



Electronic-Optical Characteristics

1). Forward Current I_F - V_F

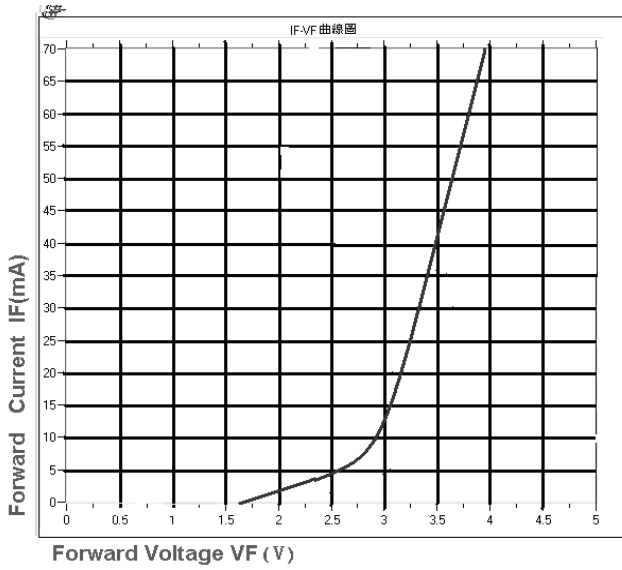

2). Relative Luminous Intensity- I_F

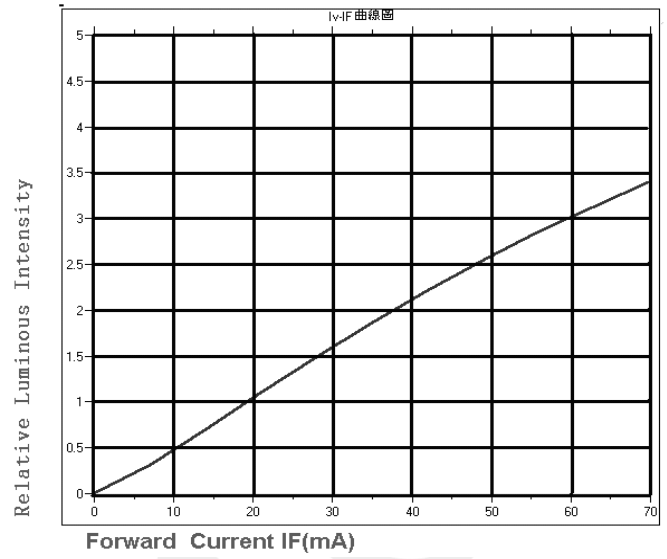

3). Relative Luminous Intensity- T_a

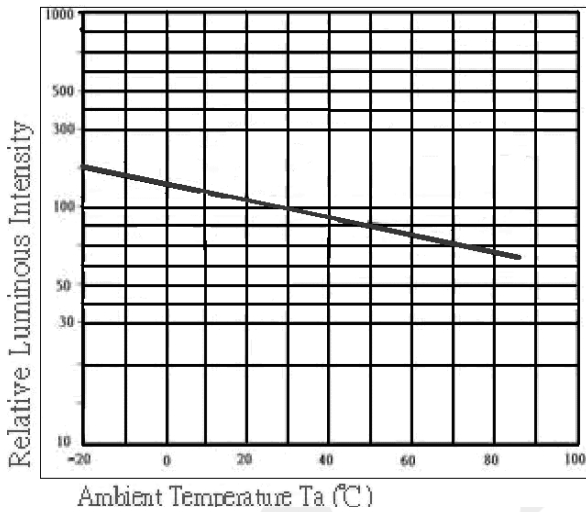

4). Forward Current I_F - T_a

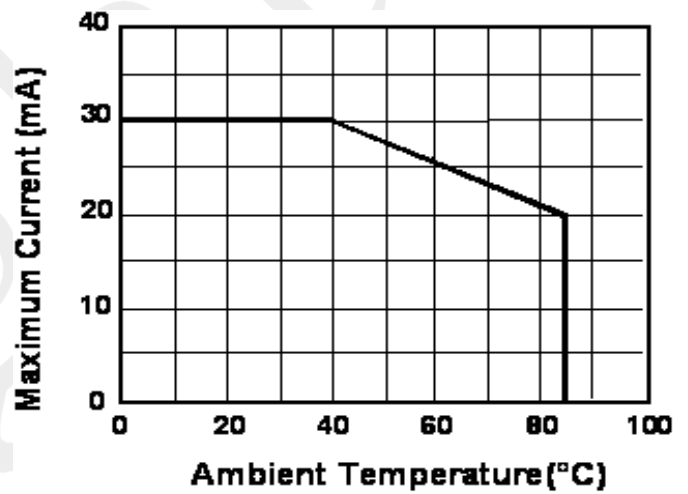

5). Forward Voltage- T_a

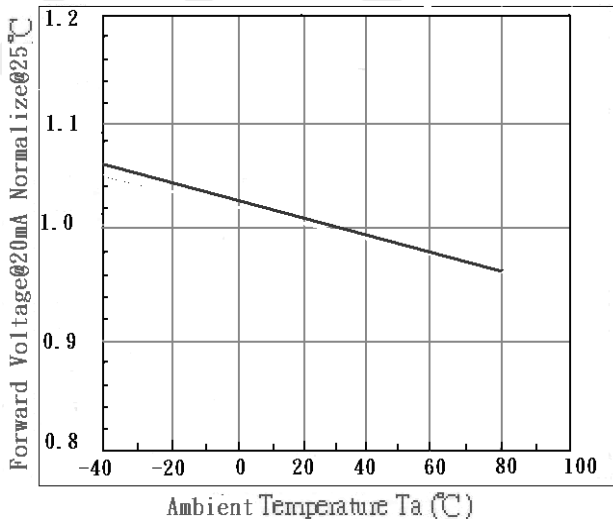

6). Wavelength Characteristics ($T_a=25^\circ\text{C}$)

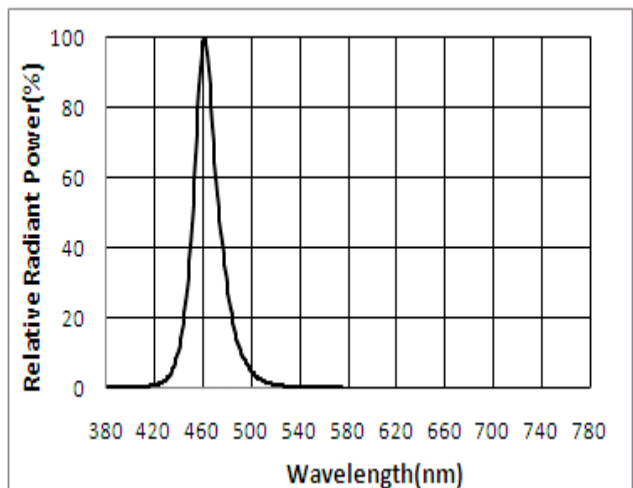

■ Dimensions

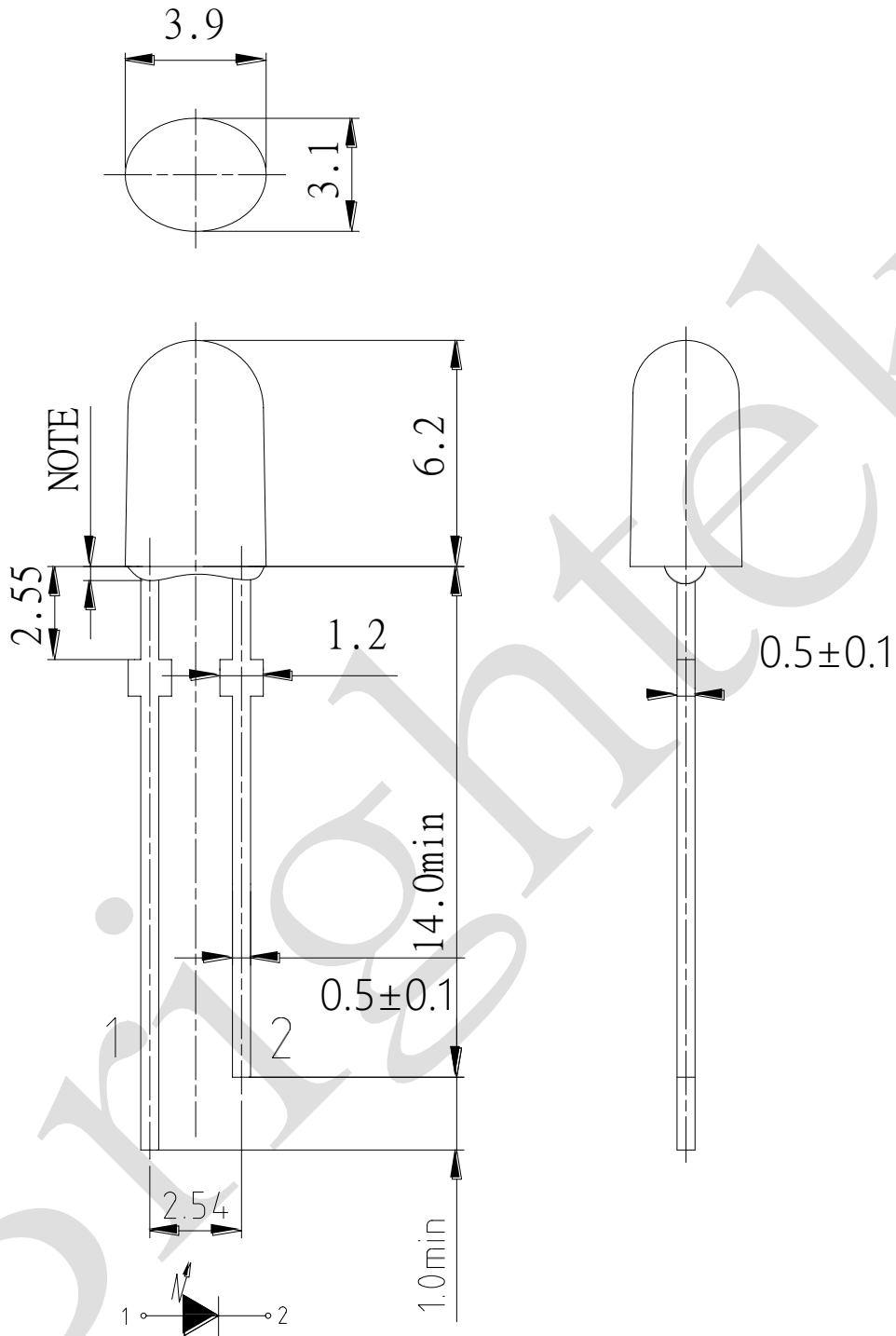

- Notes: 1. All measurements are ± 0.3 mm unless otherwise indicated.
 2. The appearance of encapsulation tolerance is ± 0.25 mm
 3. The maximum dimensions of protruded resin flange (NOTE) is 1.0mm

■ Packing

1. Package bag: vinyl bag(1,000pcs per bag)
2. Label: label as below(label on the left)

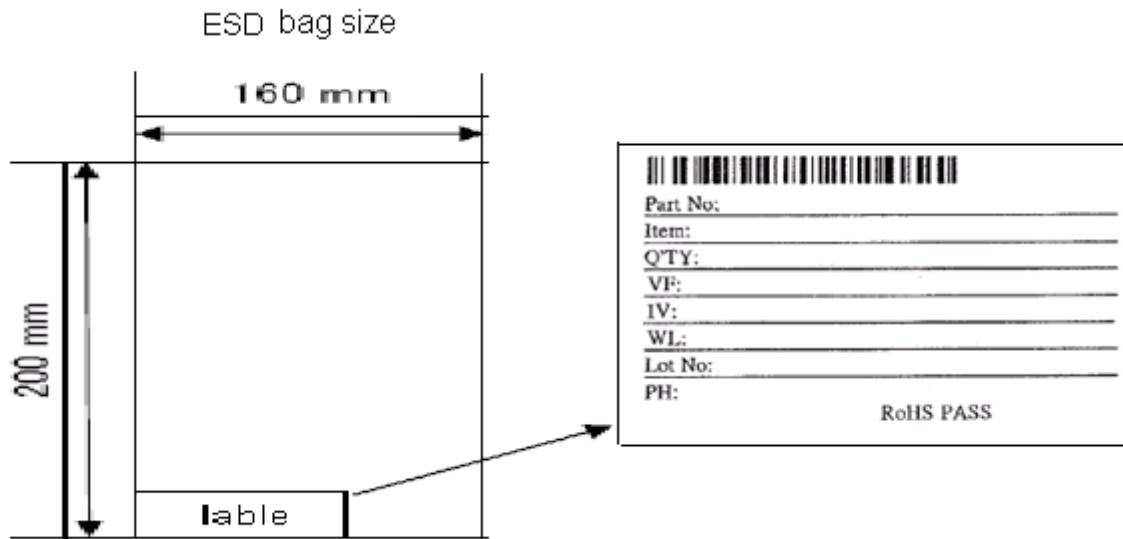

3. Package
 - 3.1. ESD bag: 12bags per carton (12,000pcs per carton)
 - 3.2. Carton size: 330*135*330mm

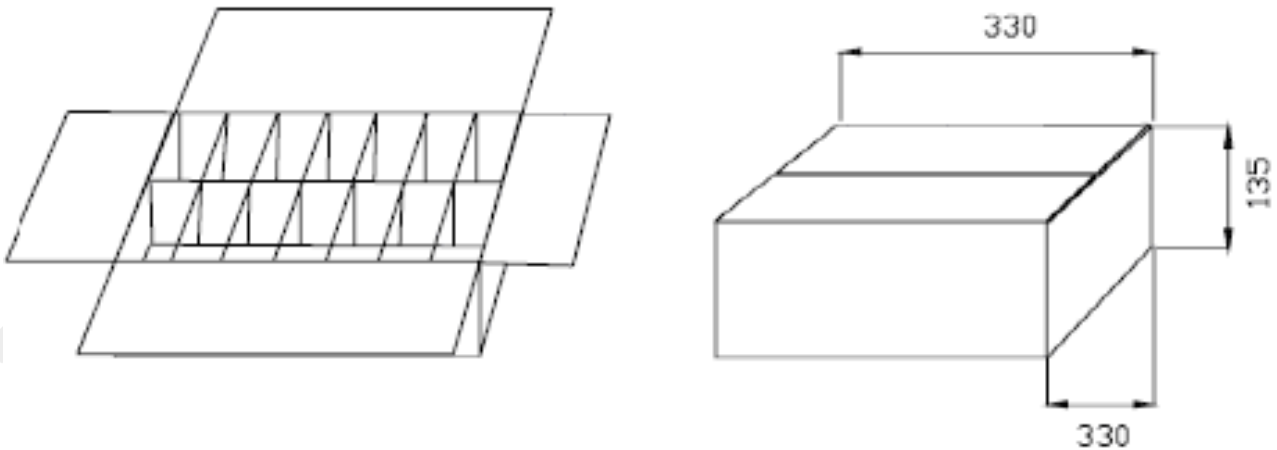

4. Falling
The falling off of the device: we have to ensure the max loss number of LAMP is 2pcs.
5. Different rank
The product of different rank will be separate in the same box

■ Precautions

A. Storage

It can be stored for 3 months under conditions of Temperature 23 ± 5 and humidity 40-70%. During storage, there must not be any damage to the sealed bag, and if opened once, do not store again. After the package is opened, the products should be used within one week under the same temperature and humidity.

B. Cleaning

Do not use any unidentified chemical to clean LEDs, it could damage or crack the LED epoxy surface. If necessary, soak LED in alcohol for a time not exceeding one minute in normal temperature.

C. Lead Frames Shaping & Trimming

1. The shaping should be done underneath the wedge point. No pressure should be exerted to the epoxy shell of the LED during shaping.
2. Shaping of the leads should be done before soldering.
3. Lead trimming should only be done at normal temperature.

D. Soldering

1. When soldering, the soldering iron needs to be at least 1.6mm away from the epoxy edge. Do not apply any pressure to the epoxy encapsulation or the lead frame during the soldering process.

2. When reflow soldering or wave soldering, please solder once for less than 5 seconds at a maximum temperature of 265°C . During the soldering process, if the temperature or timing is not controlled within limits, it would cause the epoxy to deform or cause the die or wires within the LED to be damaged.

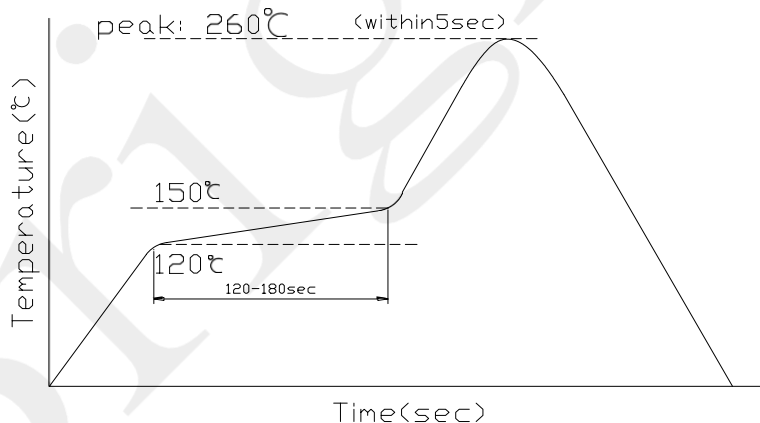

3. When using soldering iron, please solder once for less than 5 seconds at a maximum temperature of $350^{\circ}\text{C}\pm 10^{\circ}\text{C}$. When soldering a row of LED on a PCB, please do not solder both leads of a LED in sequence. (Solder the positive lead at first, then the negative leads)

4. Do not dip the epoxy encapsulation part of LED into any soldering paste liquid.
5. After soldering, do not adjust the location of the LED anymore.

■ **Precautions**

6. LED view

1) Bottom view:

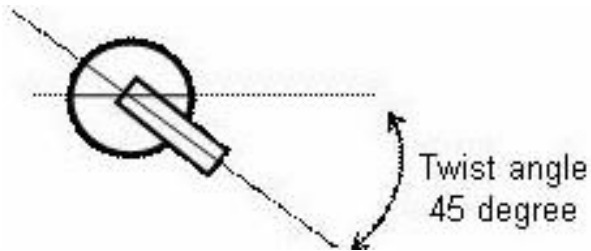

2) Side view:

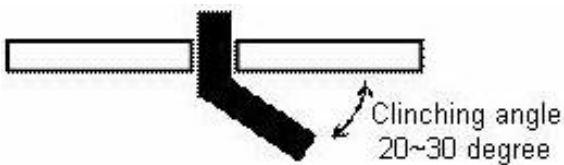

E. Installation

1. During the installation process, do not apply any pressure to the leads.
2. Please make sure the installation holes on the PCB matches the leads of the LED.

F. ESD (Electrostatic Discharge)

1. LED is very sensitive to ESD; please make sure during the whole usage and installation process, that no ESD exist to affect the LED. Excessive ESD could damage the LED chip and result in performance degradation.
2. LED can also be damaged by electrical surge, please make sure any driving electrical circuits are equipped with surge protection.
3. During the installation process, please make sure all the equipment and personnel are grounded properly. Make use ESD protection equipment such as anti-static gloves, anti-static wrist bands, anti-static mats, anti-static clothes, anti-static shoes, and anti-static containers.
4. When LED come into contact with low electrical resistance metallic surfaces, the ESD could damage the LED due to sudden discharge of ESD. Please make sure all surfaces that will be in contact with LED are covered with anti-static mats (Surface electrical resistance of $10^6 \sim 10^8 \Omega/\text{sq}$). LED should be placed in anti-static containers and anti-static bags.

■ Precautions

G. Recommended Usage Guidelines

1. Please only use 20mA (Lamp LED) and 30mA (High Flux LED) of forward current to drive LEDs whether one LED or multiple LEDs are being used.

2. Circuit connections

i. Serial connection

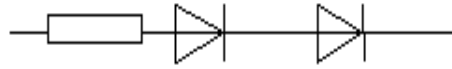

ii. Parallel connection

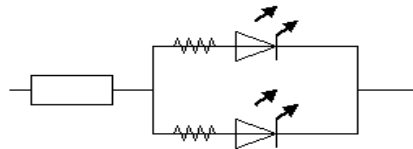

3. Sudden surge could damage the LED interior connections. Please design circuit with care so no sudden voltage surge or current surge will show when turning the circuit on or off.

4. When color or brightness uniformity is required while using multiple LEDs, the LED driver condition is critical. Our company guarantees the uniformity of the LEDs from the same bin when the driver current is 20mA (Lamp LED) and 30mA (High Flux LED)

5. A Clinch should be performed prior to soldering .Avoid excessive stress to the LED lamps when mounting (Please carry out at the minimum angle which can hold parts. As for both anode and cathode side recommend 15°C or more .Please fully perform a mounting check in the case of use on conditions other than this.)

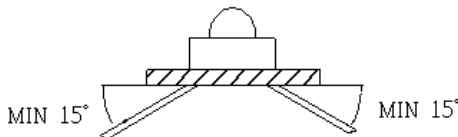

H. Safety

1. Please comply with government electrical safety code while using the LEDs.
2. Do not look directly into a lit LED; it could damage the eyes after only a few seconds.
3. Do not look directly into powered UV LEDs; it could damage the eyes after only a few seconds. (UV LEDs are mainly used in currency validating machines)

I. Direction

1. We are sending you our specification and drawings for your approval. Please return to us one copy "For Approval" with your approved signatures.
2. Comply with HSF request of customers

■ Test Items and Results of Reliability

Test Item	Test Conditions	Duration/ Cycle	Number of Damage	Reference
Temperature Cycle	-40°C 30min ↑↓ 1 min 85°C 30min	100 cycles	0/22	JEITA ED-4701 300 303
High Temperature Storage	T _a =100±5°C	1000 hrs	0/22	EIAJED-4701 200 201
High Humidity Heat Life Test	T _a =85°C RH=85% I _F =20mA	500 hrs	0/22	Tested with Brightek standard
Humidity Heat Storage	T _a =85°C RH=85%	1000 hrs	0/22	EIAJED-4701 100 103
Life Test	T _a =25°C I _F =20mA	1000 hrs	0/22	Tested with Brightek standard
Low Temperature Life Test	T _a = -40°C I _F =20mA	1000 hrs	0/22	Tested with Brightek standard
High Temperature Life Test	T _a =85°C I _F =20mA	1000 hrs	0/22	Tested with Brightek standard

*Criteria for Judging				
Item	Symbol	Condition	Criteria for Judgment of Pass	
			Min	Max
Forward Voltage	V _F	I _F =20mA	-	USL* ¹ ×1.1
Reverse Current	I _R	V _R = 5V	-	10μA
Luminous Intensity	I _v	I _F =20mA	LSL* ² ×0.7	-

[Note] USL*¹: Upper Specification Level

LSL*²: Lower Specification Level