

6SC2214A21A0CM01

◆Outline(L*W*H): 2.2*1.4*1.3 mm

◆Good thermal dissipation & optical uniformity



Table of Contents

Product Code Method-----	2
Maximum Rating-----	2
Typical Product Characteristics-----	3
Range of Bins-----	3
Directive Characteristics-----	5
Electronic-Optical Characteristics-----	6
Dimensions -----	7
Packing-----	8
Precautions -----	9
Test Items and Results of Reliability-----	12

Features

- Forward current: $\leq 30\text{mA}$
- Typical view angle 50% I_v : 120°
- RoHS2.0 and REACH-compliant
- Lens color: water transparent
- Qualified according to JEDEC moisturevity Level 2a
- ESD level 2kV(HBM)
- Reliability Test: AEC Q-102qualified

Applications

- Indoor lighting applications
- Flat backlight for LCD. Switch and symbol
- Indicator and backlighting for all consumer electronics
- Others applications
- Automotive electronics

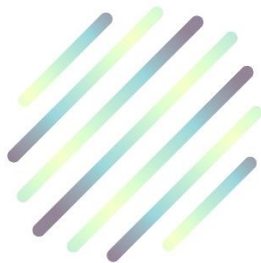

■ **Product Code Method**

6 - S - C - 2214 - A21A - 0 - C - M - 01

① ② ③ ④ ⑤ ⑥ ⑦ ⑧ ⑨

①	②	③	④	⑤
Process Type	Category	LED Type	Lead Frame Size	Dice wavelength & luminous rank
6 : special product	S: SMD LED	C: PLCC top view D: PLCC side view	2214: 2.2* 1.4mm	Axxx: amber

⑥	⑦	⑧	⑨
Lap Polarity	Cap Color	PCB Module Code	Flow Code
0: non-common anode and non-common cathode	C: water transparent	M: article mode	01: no expression above meaning for company

■ **Maximum Rating(Ta=25°C)**

Characteristics	Symbol	Typical	Unit
DC Forward Current	I _F	30	mA
Pulse Forward Current ^{*3}	I _{PF}	100	mA
Reverse Voltage	V _R	10	V
Junction Temperature	T _J	125	°C
Operating Temperature Range	T _{OP}	-40-105	°C
Storage Temperature Range	T _{STG}	-40-105	°C
Soldering Temperature ^{*4}	T _{SD}	260	°C
Thermal Resistance Junction/ Solder Point	R _{th}	160	°C/W

Notes 1: There is no maximum or typical voltage parameter

2: For other ambient, limited setting of current will be depended on de-rating curves.

3: Duty 1/10, pulse width 0.1ms

4: The maximum of soldering time is 5 seconds in T_{SD}

■ Typical Product Characteristics(Ta=25°C)

Characteristics	Symbol	Min.	Typ.	Max.	Unit	Test condition
Forward Voltage	V_F	1.7	1.9	2.5	V	$I_F=20mA$
Luminous Intensity	I_v	120	200	-	mcd	$I_F=20mA$
Dominant Wavelength	λ_d	600	-	612	nm	$I_F=20mA$
Reverse Current	I_R	-	-	10	μA	$V_R= 10V$
Viewing Angle	$2\theta_{1/2}$	-	120	-	deg	$I_F=20mA$

Notes: 1. Measurement errors:

Forward Voltage: $\pm 0.1V$, Luminous Intensity: $\pm 10\%I_v$, Dominant Wavelength: $\pm 1.0nm$

2. Electrical-Optical Characteristics (Ta=25°C)

■ Range of Bins

1).Forward Voltage ($I_F = 20mA$)

Bin Code	Min. V_F (V)	Max. V_F (V)
A	1.7	1.8
B	1.8	1.9
C	1.9	2.0
D	2.0	2.1
E	2.1	2.2
F	2.2	2.3
G	2.3	2.4
H	2.4	2.5

2).Luminous Intensity ($I_F = 20mA$)

Bin Code	Min. I_v (mcd)	Max. I_v (mcd)
7	120	160
8	160	210
9	210	270
10	270	350

■ Range of Bins

3).Dominant Wavelength ($I_F = 20\text{mA}$)

Bin Code	Min. λ_d (nm)	Max. λ_d (nm)
B	600	603
C	603	606
D	606	609
E	609	612



Brightek

Optical Characteristics

1). Relative Spectral Distribution

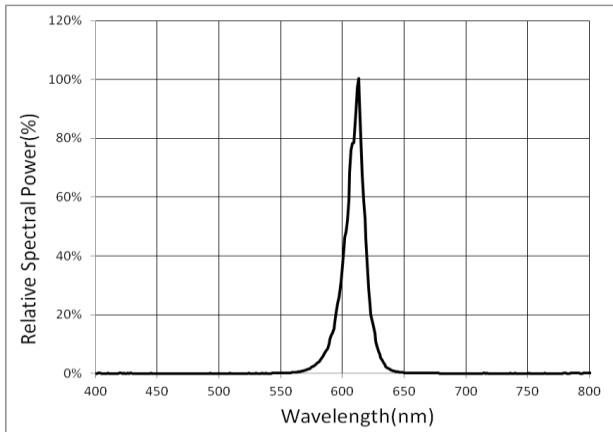

2). Typical Spatial Distribution

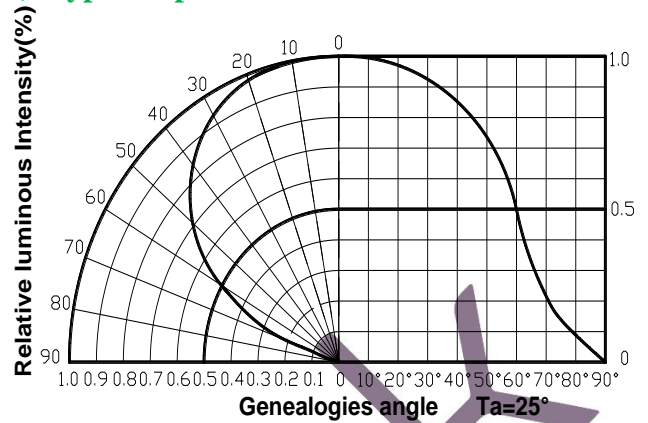

3). Relative Luminous Flux .Current

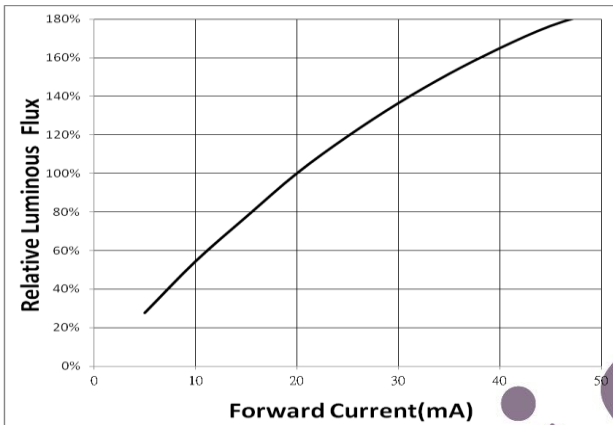

4). Relative Luminous Flux .Ambient Temperature

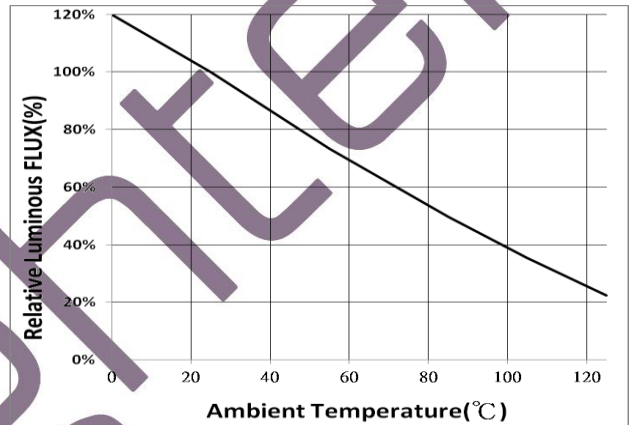

5). Electrical Characteristics

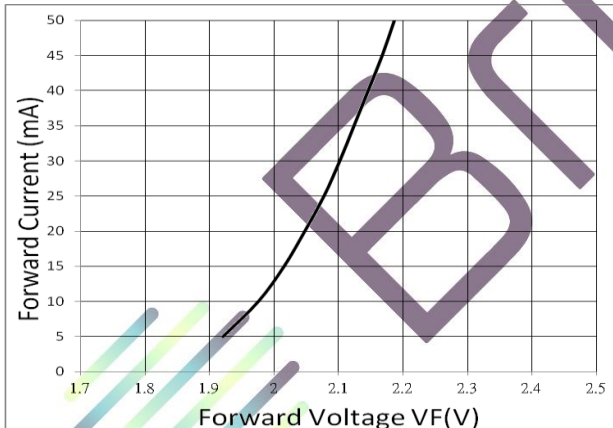

6). Relative Forward Voltage Temperature

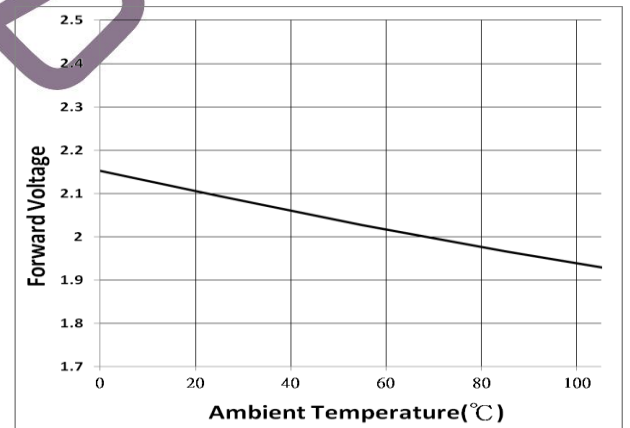

7). Relative Wavelength and Temperature

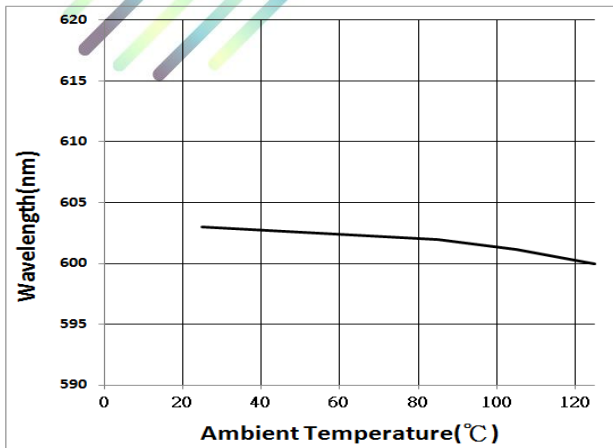

8). Thermal Design

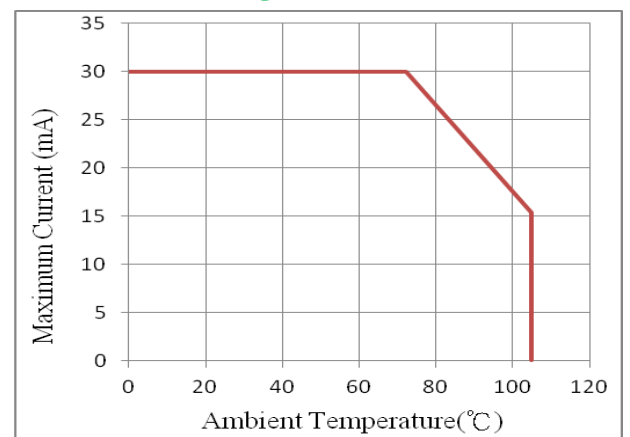

■ Dimensions

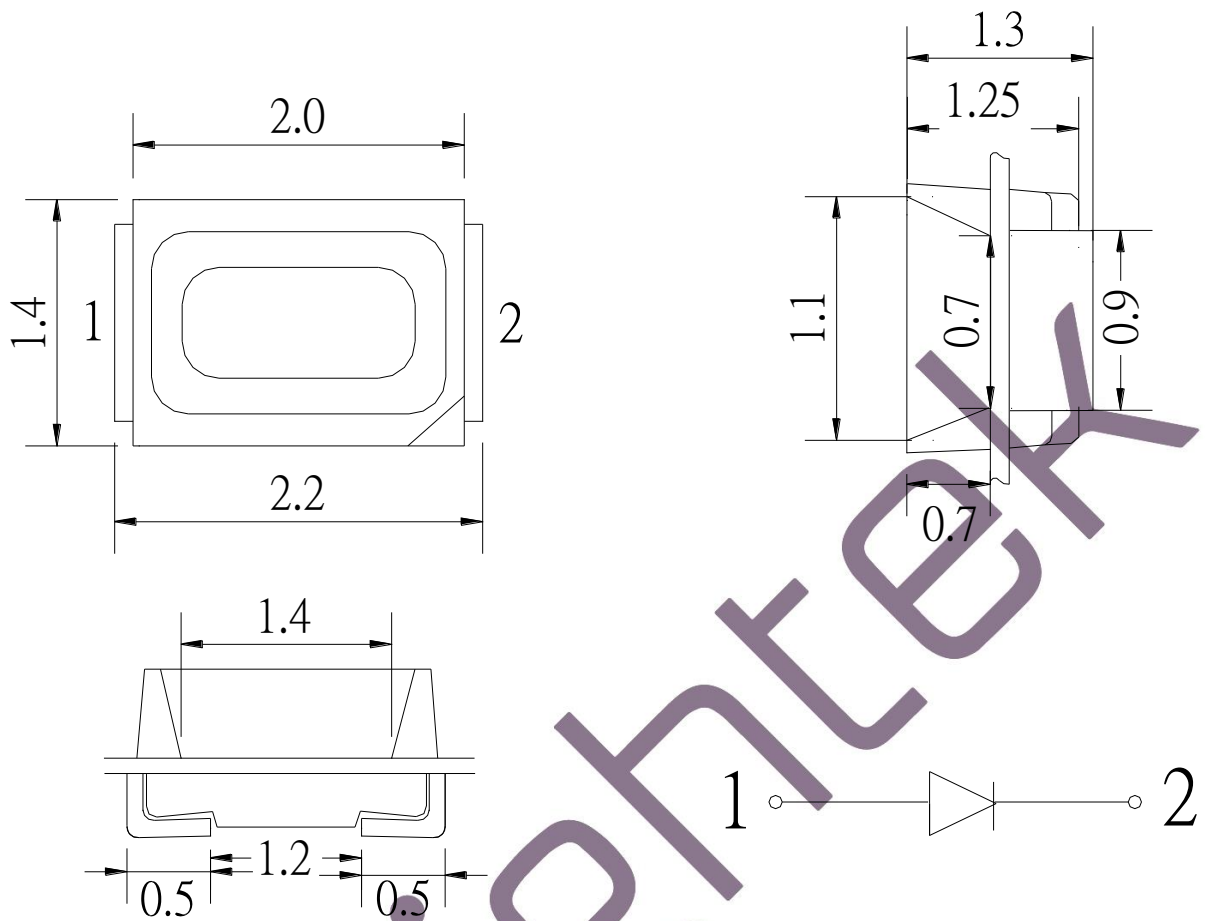

Recommend Pad layout

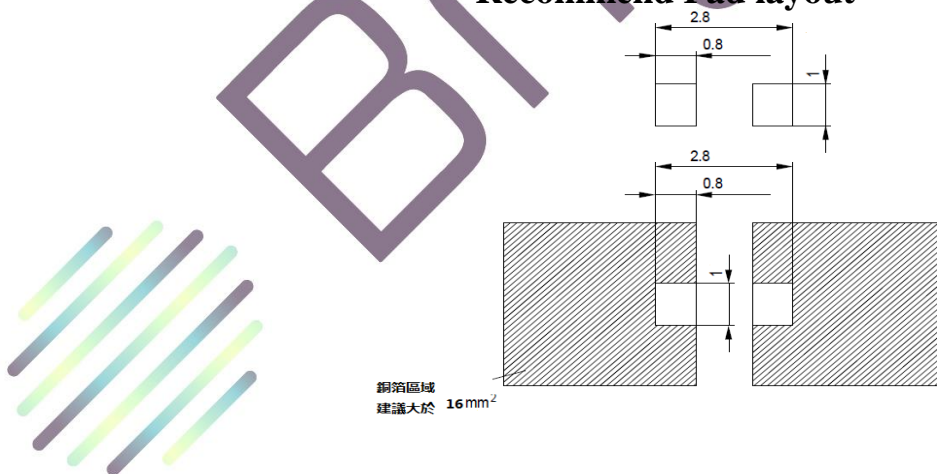

- Notes:
1. All dimensions are in millimeters (inches)
 2. Tolerance is ± 0.1 (± 0.004 ") mm unless otherwise noted
 3. Specifications are subject to change without notice.

■ Reflow Profile

1. IR reflow soldering Profile for Lead Free solder

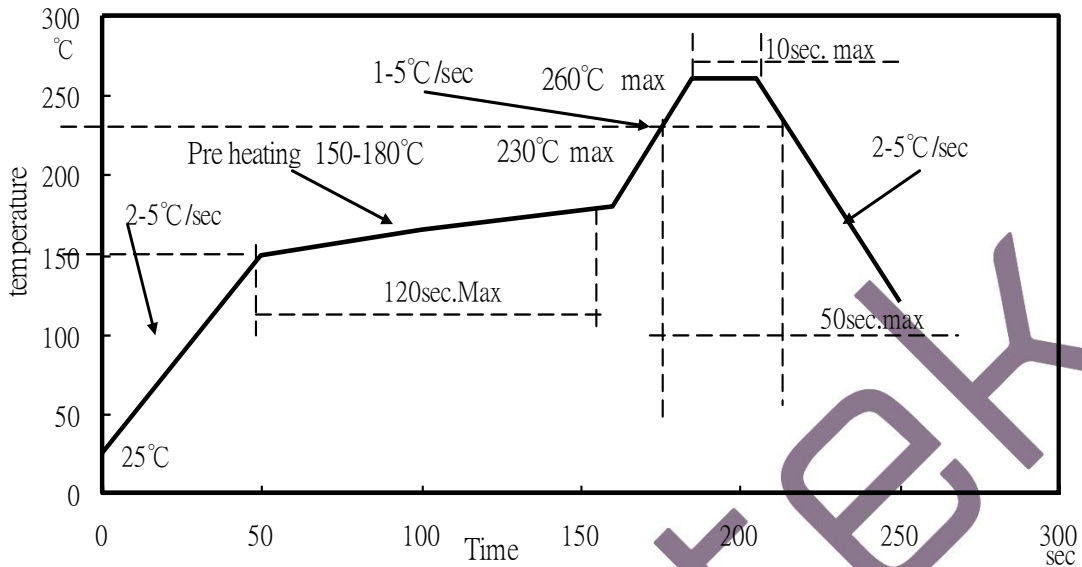

Notes:

1. We recommend the reflow temperature 240°C (±5°C).the maximum soldering temperature should be limited to 260°C.
2. Don't cause stress to the silicone resin while it is exposed to high temperature.
3. Number of reflow process shall be less than 3 times.



■ **Test Circuit and Handling Precautions**

1. Test Circuit

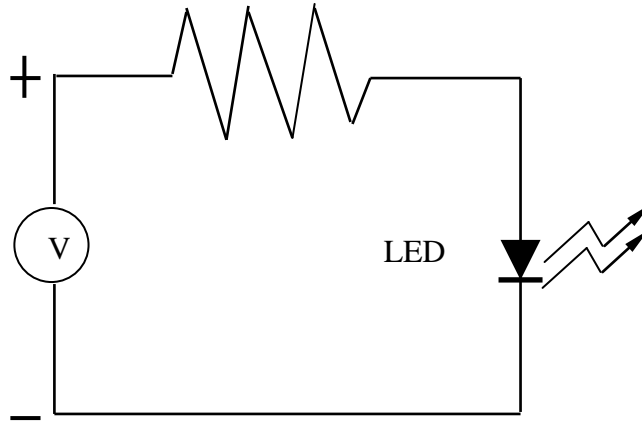

2. Handling Precautions

2.1. Over-current-proof

Customer must apply resistors for protection; otherwise slight voltage shift will cause big current change (Burn out will happen).

2.2. Storage

1). It is recommended to store the products in the following conditions:

Humidity: 60% R.H. Max.

Temperature: 5°C~30°C (41°F~86°F)

2). Shelf life in sealed bag: 12 month at <5°C~30°C and <60% R.H. after the package is Opened, the products should be used within four weeks or they should be keeping to stored at ≤20%R.H. with zip-lock sealed.

2.3. Baking

If the package has been opened for more than 4 weeks, it is recommended to bake the products with the following instruction:

1). 60±3°C X 6hrs and <5%RH, for reel

2). 125±3°C X 2hrs, for single LED

It shall be normal to see slight color fading of carrier (light yellow) after baking in process

■ Packing

● Feeding Direction (Unit: mm)

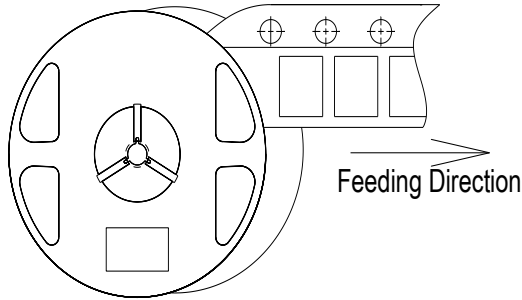

● Dimensions of Reel (Unit: mm)

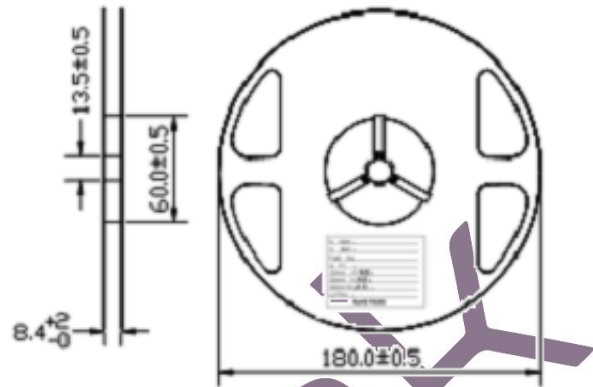

● Dimensions of Tape (Unit: mm)

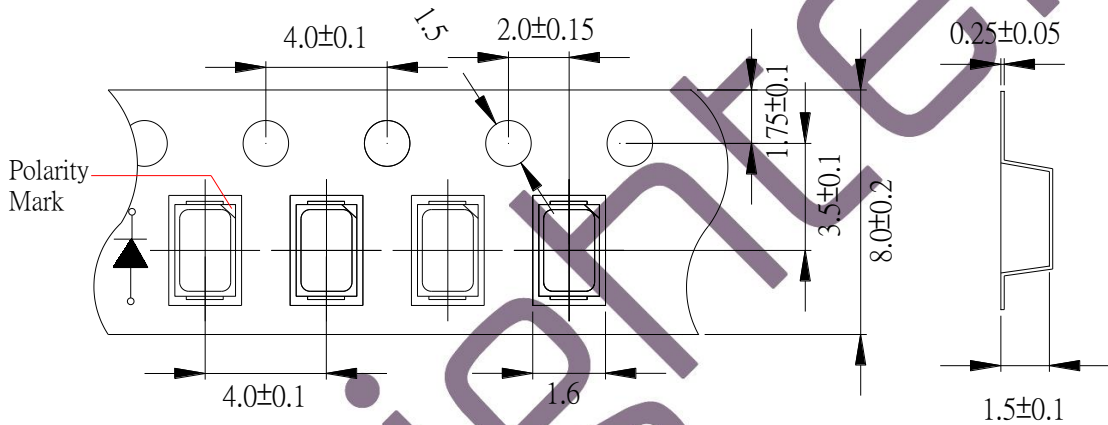

● Arrangement of Tape

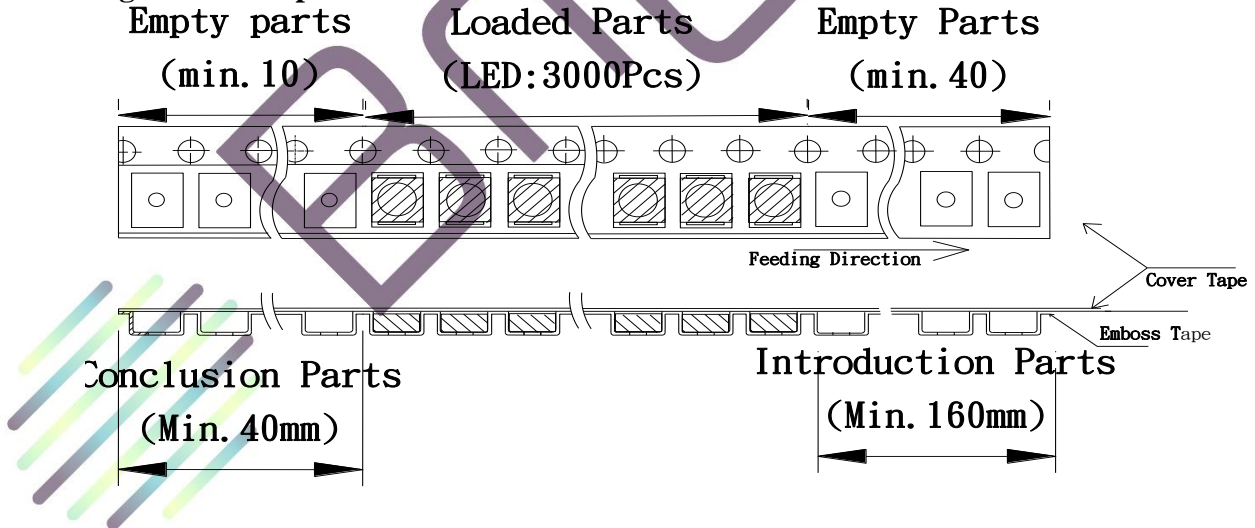

Notes:

1. Empty component pockets are sealed with top cover tape
2. The max loss number of SMD is 2pcs;
3. The cathode is oriented towards the tape sprocket hole in accordance with ANSI/EIA RS-481 specifications;
4. 3,000pcs per reel;
5. The remainder packing in multiples of 500pcs.

■ Packing

● Packaging Specifications

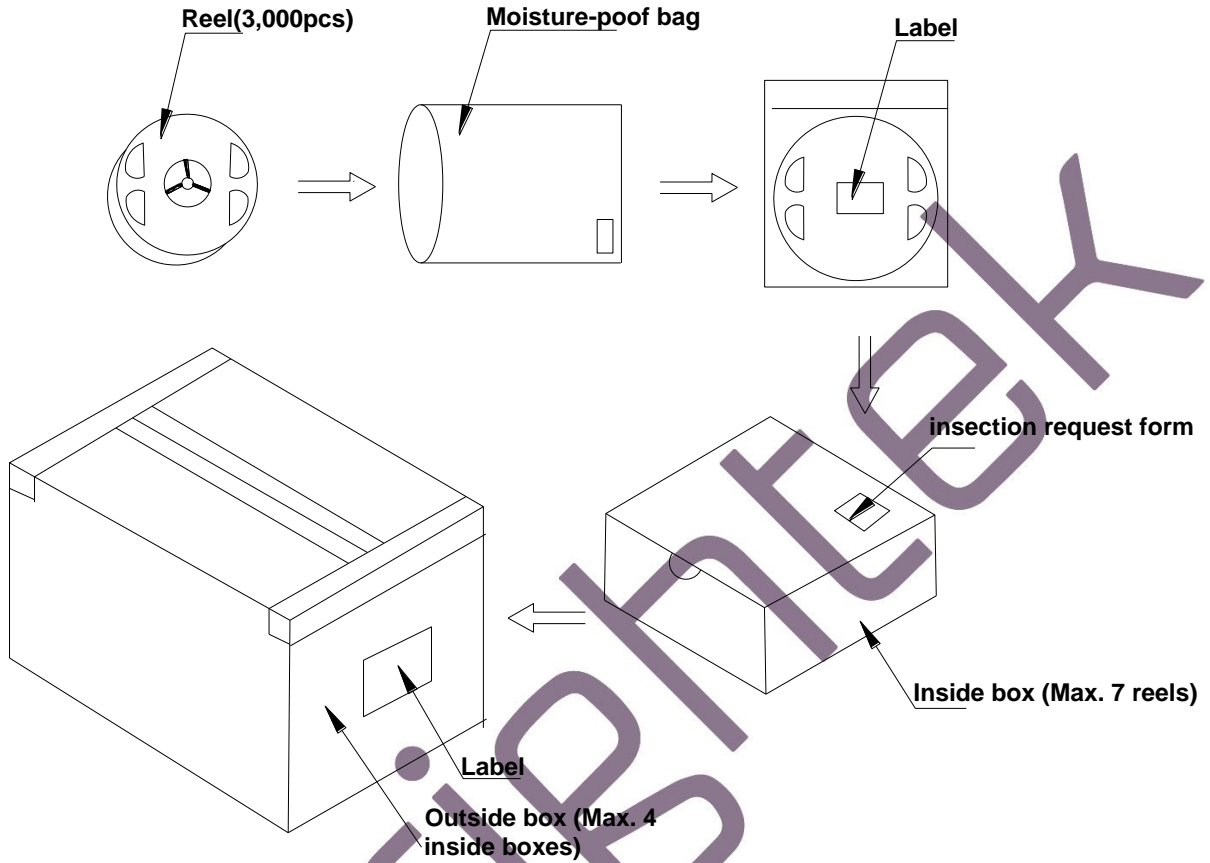

Notes:

Reeled product (max.3,000) is packed in a sealed moisture-proof bag. Seven bags are packed in an inner box (size: about 260 X 230 X 100 mm) and four inner boxes are in an outer box (size: about 480 X 275 X 215 mm). On the label of moisture-proof bag, there should be the information of Part No., Lot No. and quantity number; also the total quantity number should be on inspection request form on outer box.

■ **Precautions**

1. Abnormal situation caused by improper setting of collet

To choose the right collet is the key issue in improving the product's quality. LED is different from other electronic components, which is not only about electrical output but also for optical output. This characteristic made LED more fragile in the process of SMT. If the collet's lowering down height is not well set, it will bring damage to the gold wire at the time of collet's picking up and loading which will cause the LED fail to light up, light up now and then or other quality problems

2. How to choose the collet

During SMT, please choose the collet that has larger outer diameter than the lighting area of lens, in case that improper position of collet will damage the gold wire inside the LED. Different collets fit for different products, please refer to the following pictures cross out

Outer diameter of collet should be larger than the lighting area

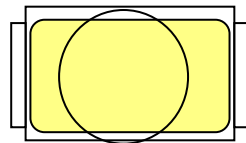

Picture 1(√)

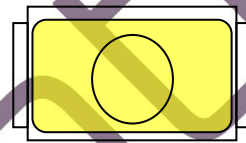

Picture 2(X)

3. Other points for attention

- A. No pressure should be exerted to the epoxy shell of the SMD under high temperature.
- B. Do not scratch or wipe the lens since the lens and gold wire inside are rather fragile and cross out easy to break.
- C. LED should be used as soon as possible when being taken out of the original package, and should be stored in anti-moisture and anti-ESD package.

4. This usage and handling instruction is only for your reference.

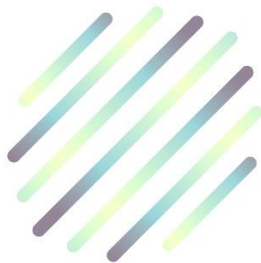

■ Test Items and Results of Reliability

Test Item	Test Conditions	Duration/ Cycle	Ac/Re	Number of Damage	Reference
Normal Temperature Life	T _a =23°C(±5°C) I _F =20mA	1008 hrs	0/1	0/22	JESD22 A-108
High Temperature Life	T _a =85°C(±5°C) I _F =20mA	1008 hrs	0/1	0/22	JESD22 A-108
High Humidity Heat Life	T _a =85°C(±5°C) RH=85% I _F =20mA	1008 hrs	0/1	0/22	JESD22 A-108
Thermal shock	-45°C/30min~105°C /30min (±5°C)	1008 hrs	0/1	0/22	JESD22 A-104
Electrostatic Discharge (ESD) Test	According to the SPEC	3 cycles	0/1	0/22	AEC Q101-001
Low Temperature Storage	T _a =-40°C	1008 hrs	0/1	0/22	JESD22-A103D
High Temperature Storage	T _a =105°C	1008 hrs	0/1	0/22	JESD22-A103D

*Criteria for Judging				
Item	Symbol	Condition	Criteria for Judgment of Pass	
			Min	Max
Forward Voltage	V _F	I _F =20mA	-	USL* ¹ ×1.1
Reverse Current	I _R	V _R = 10V	-	10μA
Luminous Intensity	I _v	I _F =20mA	LSL* ² ×0.7	-

[Note] USL*¹: Upper Specification Level

LSL*²: Lower Specification Level